



US00D616289S

(12) **United States Design Patent**
Frankel

(10) **Patent No.:** **US D616,289 S**

(45) **Date of Patent:** **** May 25, 2010**

(54) **FURNITURE PROTECTIVE DEVICE**

(76) Inventor: **Meir Frankel**, 230 Irving Pl.,
Woodmere, NY (US) 11598

(**) Term: **14 Years**

(21) Appl. No.: **29/331,683**

(22) Filed: **Jan. 30, 2009**

(51) **LOC (9) Cl.** **08-05**

(52) **U.S. Cl.** **D8/374**

(58) **Field of Classification Search** D8/373,
D8/374, 382; D11/121, 130, 131, 184; D21/108;
D24/211, 214; 248/188.2, 188.8, 346.01;
D6/449, 491, 512

See application file for complete search history.

(56) **References Cited**

U.S. PATENT DOCUMENTS

1,921,561	A *	8/1933	Christmas	248/188.9
2,644,978	A *	7/1953	Becker	16/42 R
2,784,512	A *	3/1957	Goodwin	428/8
2,809,455	A *	10/1957	De Haven	428/9
D277,727	S *	2/1985	Klaric	D8/382
4,735,873	A *	4/1988	Doundoulakis	429/49
D298,215	S *	10/1988	Davis	D8/373
D321,471	S *	11/1991	Stumpf et al.	D8/400
D349,233	S *	8/1994	Terrell	D8/374
D404,681	S *	1/1999	Galerieau	D11/121

5,945,178	A *	8/1999	Volkman	428/11
D502,264	S *	2/2005	Timmer	D24/211
D527,617	S *	9/2006	Powell et al.	D8/374
D548,576	S *	8/2007	Bushey et al.	D8/374
7,404,232	B2 *	7/2008	Chase	16/42 T
D596,306	S *	7/2009	Levine	D24/214

* cited by examiner

Primary Examiner—Sandra Snapp

Assistant Examiner—Patricia Palasik

(74) *Attorney, Agent, or Firm*—Stroock & Stroock & Lavan
LLP

(57) **CLAIM**

The ornamental design for a furniture protective device, as shown and described.

DESCRIPTION

FIG. 1 is a perspective view of a furniture protective device being used with a chair, the chair being shown in dashed lines;

FIG. 2 is a front elevational view thereof;

FIG. 3 is a top elevational view thereof;

FIG. 4 is a side elevational view thereof; and,

FIG. 5 is a bottom plan view thereof.

The portions shown in dashed lines, including the dashed lines showing the scored X-shaped furniture insertion portion of the device, do not form part of the claimed design.

1 Claim, 3 Drawing Sheets

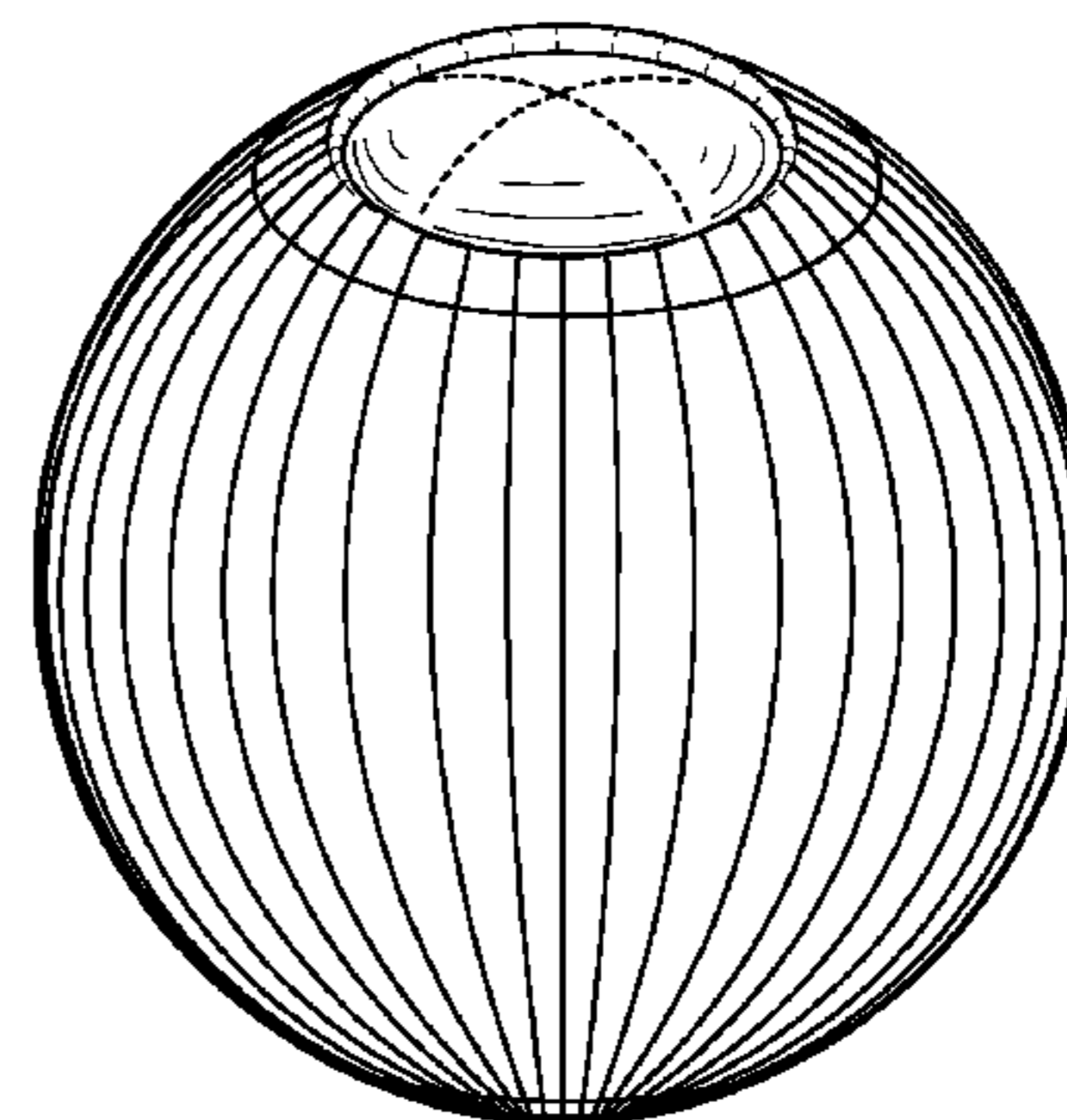
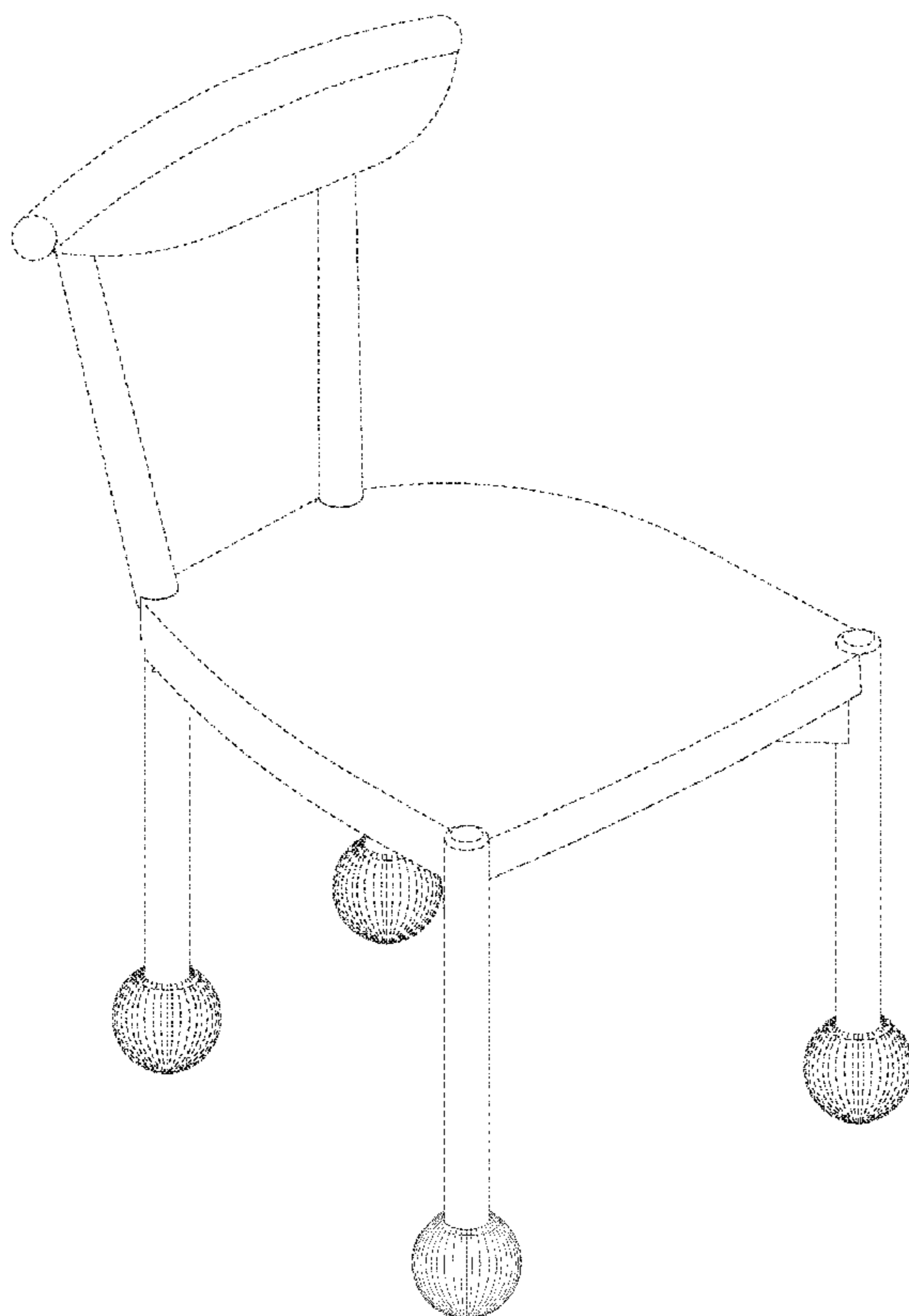

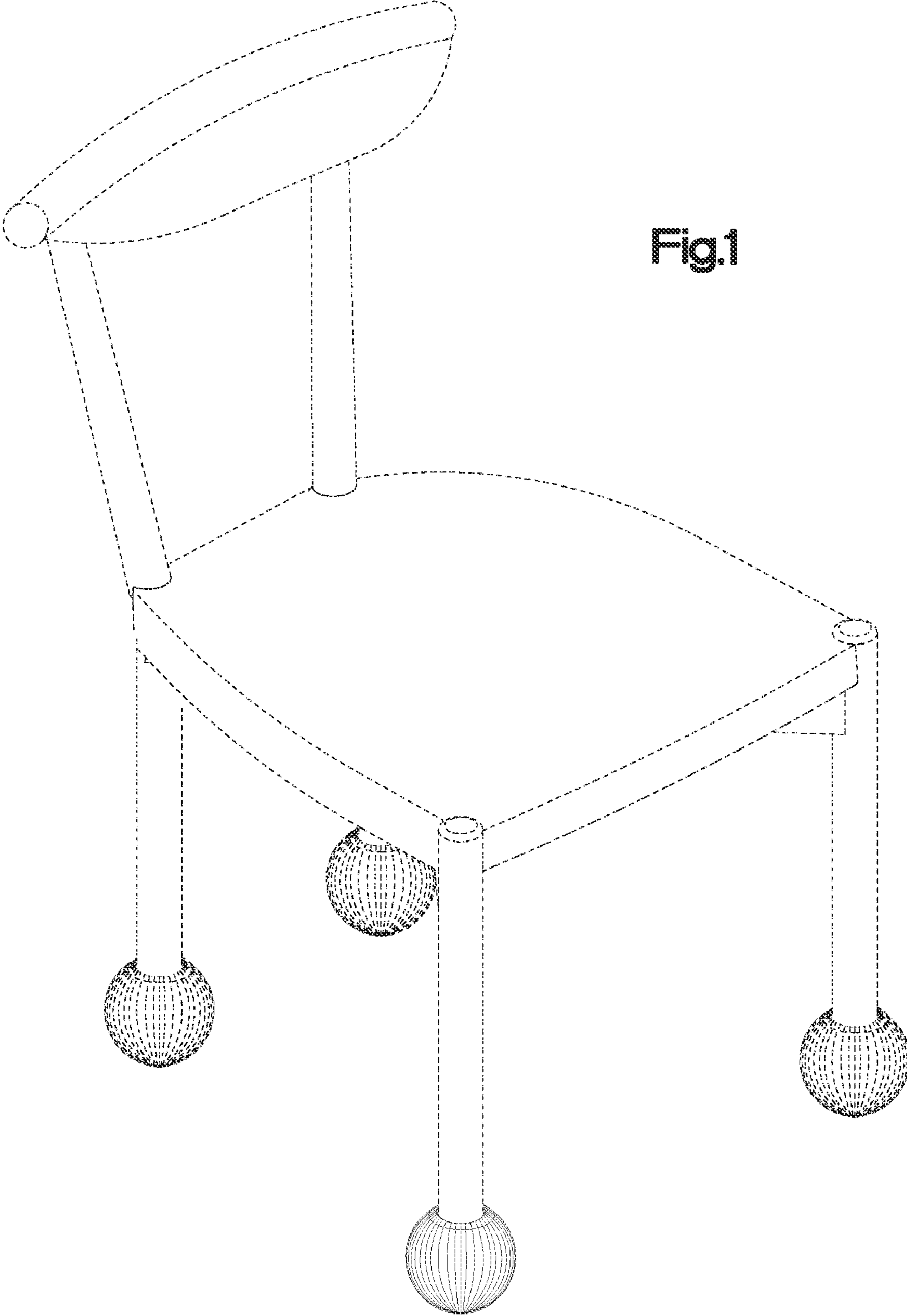

Fig. 1

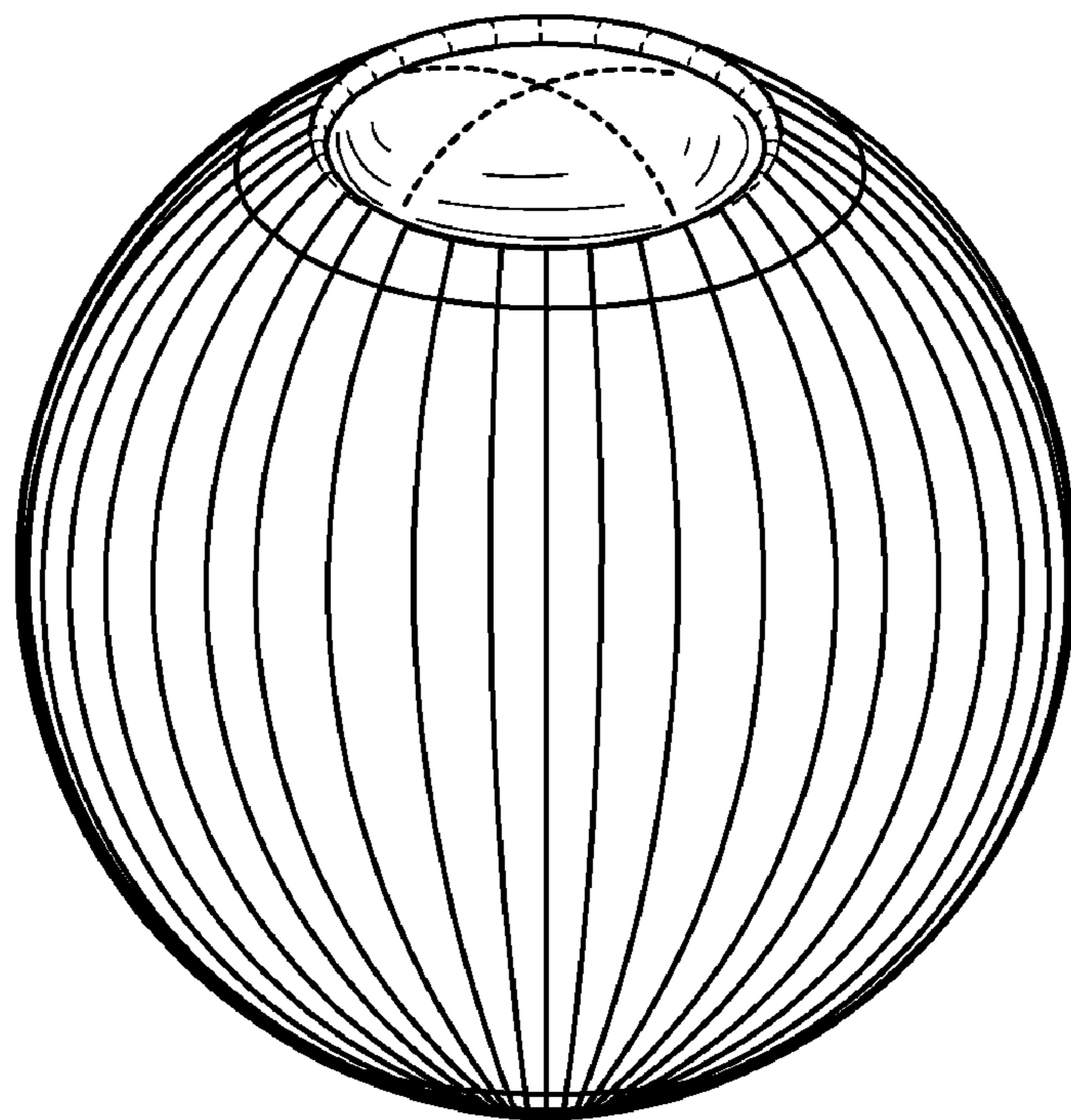

Fig.2

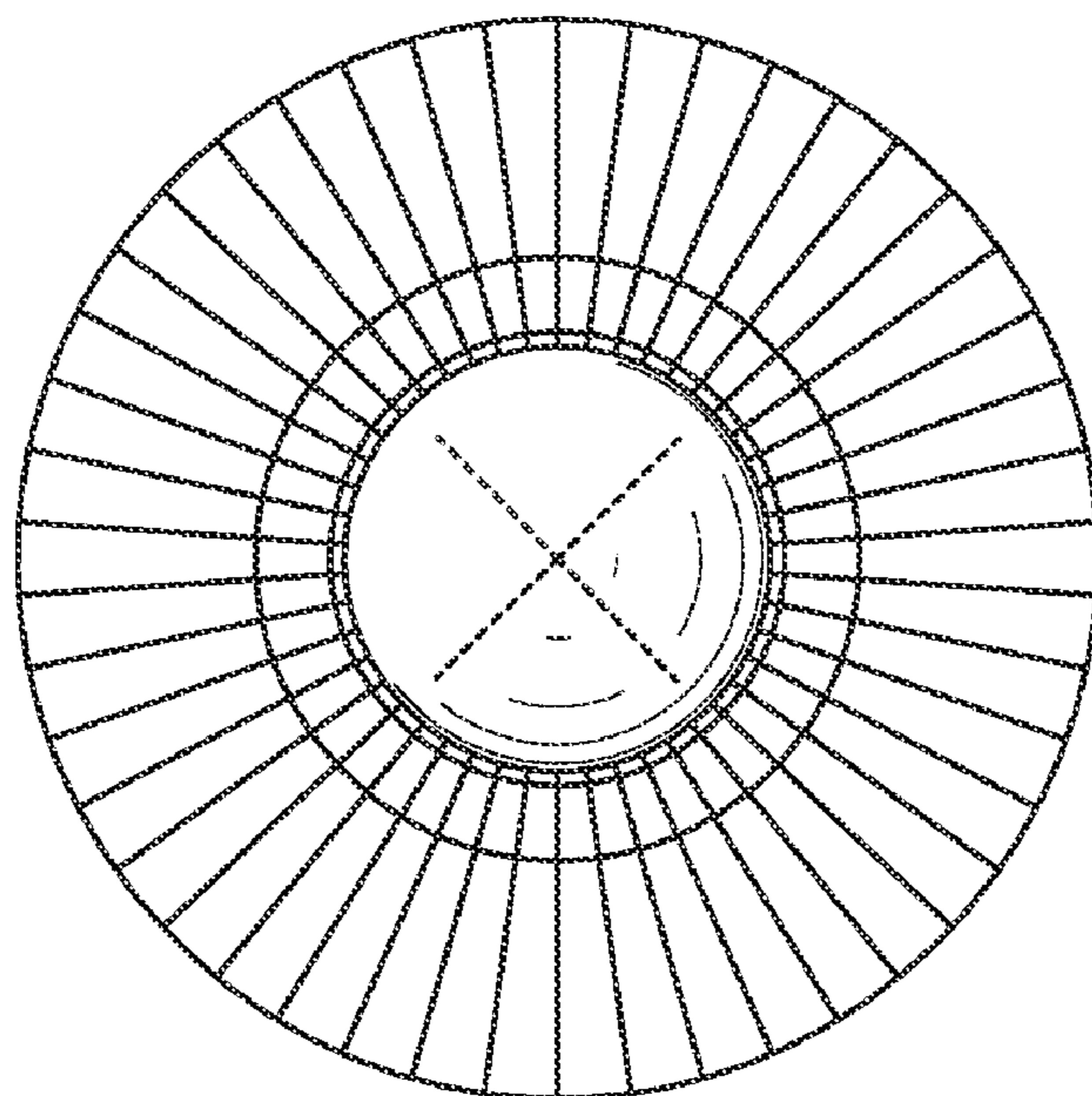

Fig.3

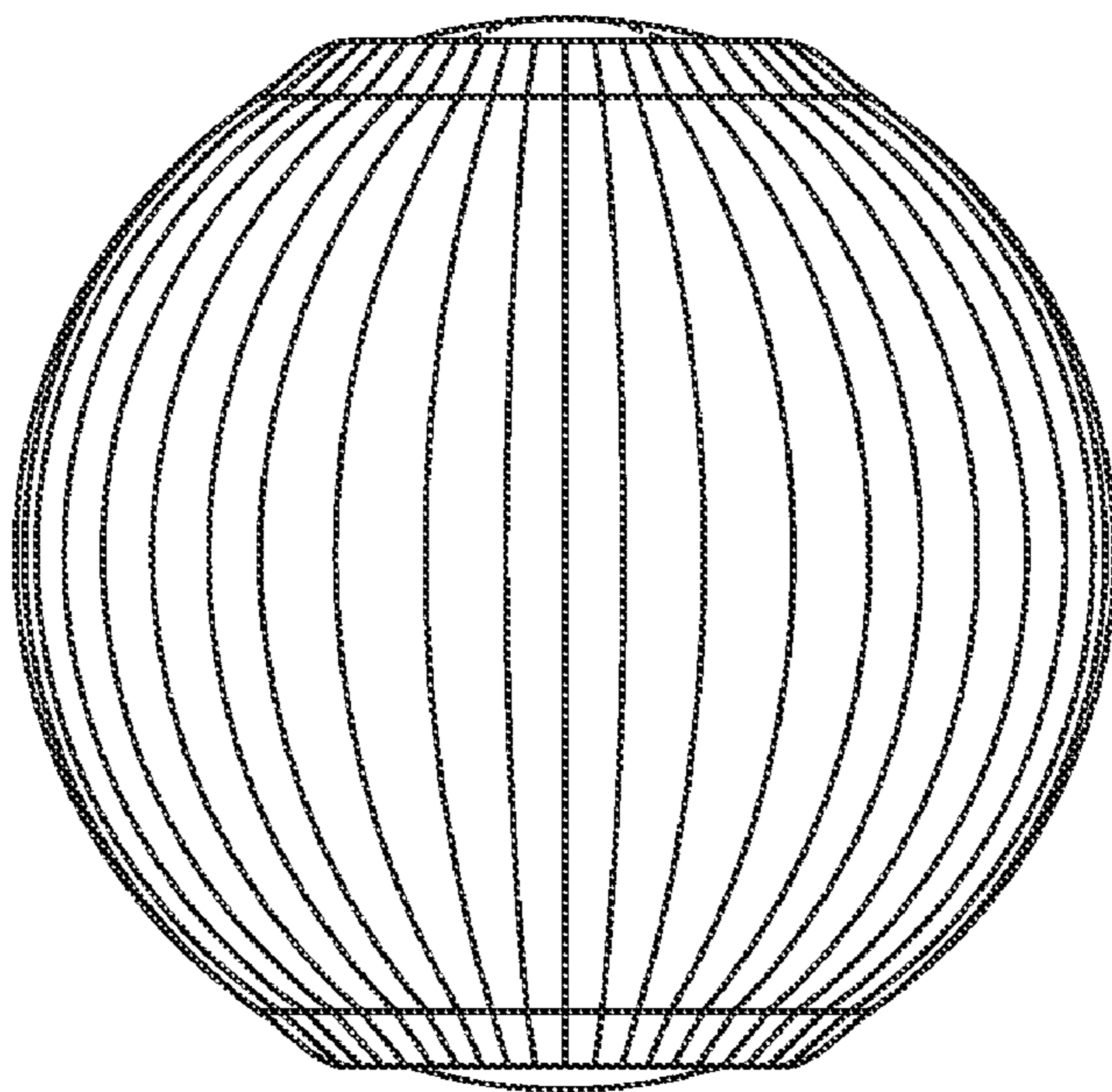

Fig.4

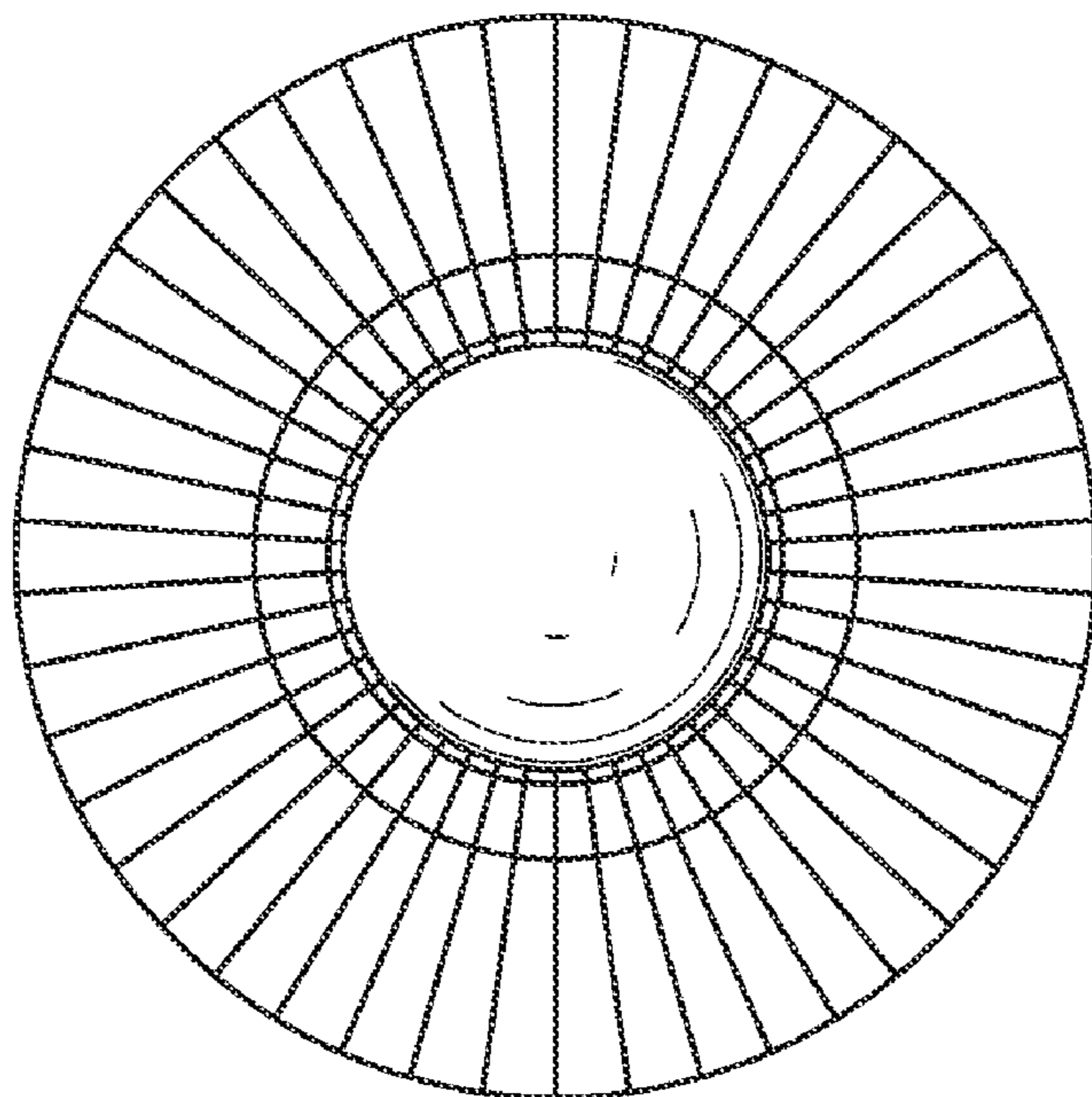

Fig.5