



US00D616201S

(12) **United States Design Patent**  
**Bui**

(10) **Patent No.:** **US D616,201 S**  
(45) **Date of Patent:** **\*\* May 25, 2010**

(54) **BASKET**

D517,806 S \* 3/2006 Charuwongkhachton ..... D3/305  
D547,950 S \* 8/2007 Kellogg et al. .... D3/305  
7,614,517 B2 \* 11/2009 Zheng ..... 220/9.2

(76) Inventor: **Khamping Bui**, Landbachstrasse 2,  
Zuzwil (CH) CH-9524

\* cited by examiner

(\*\*) Term: **14 Years**

*Primary Examiner*—Robert M Spear  
*Assistant Examiner*—Rashida C McCoy

(21) Appl. No.: **29/329,633**

(74) *Attorney, Agent, or Firm*—Fitch, Even, Tabin &  
Flannery

(22) Filed: **Dec. 18, 2008**

(30) **Foreign Application Priority Data**

(57) **CLAIM**

Jun. 19, 2008 (CH) ..... 135225

I claim the ornamental design for basket, as shown and  
described.

(51) **LOC (9) Cl.** ..... **03-01**

(52) **U.S. Cl.** ..... **D3/305**

(58) **Field of Classification Search** ..... D3/304–315,  
D3/319; 206/216, 307.1, 503–505, 509,  
206/510, 514, 555, 561, 557; 220/500, 1.5,  
220/6, 7, 509, 516, 9.1, 9.2, 9.3, 9.4, 485,  
220/486, 487

**DESCRIPTION**

See application file for complete search history.

FIG. 1 is a front perspective view of the basket of my new  
design;

FIG. 2 is a left side view of the basket shown in FIG. 1;

FIG. 3 is a front view of the basket shown in FIG. 1;

FIG. 4 is a right side view of the basket shown in FIG. 1;

FIG. 5 is a rear view of the basket shown in FIG. 1;

FIG. 6 is a bottom view of the basket shown in FIG. 1;

FIG. 7 is a top view of the basket shown in FIG. 1;

FIG. 8 is a front view of the basket shown in FIG. 1 folded in  
a first position;

FIG. 9 is a side view of the basket shown in FIG. 1 folded in  
a second position; and,

FIG. 10 is a front view of the basket of FIG. 9 folded in a  
second position.

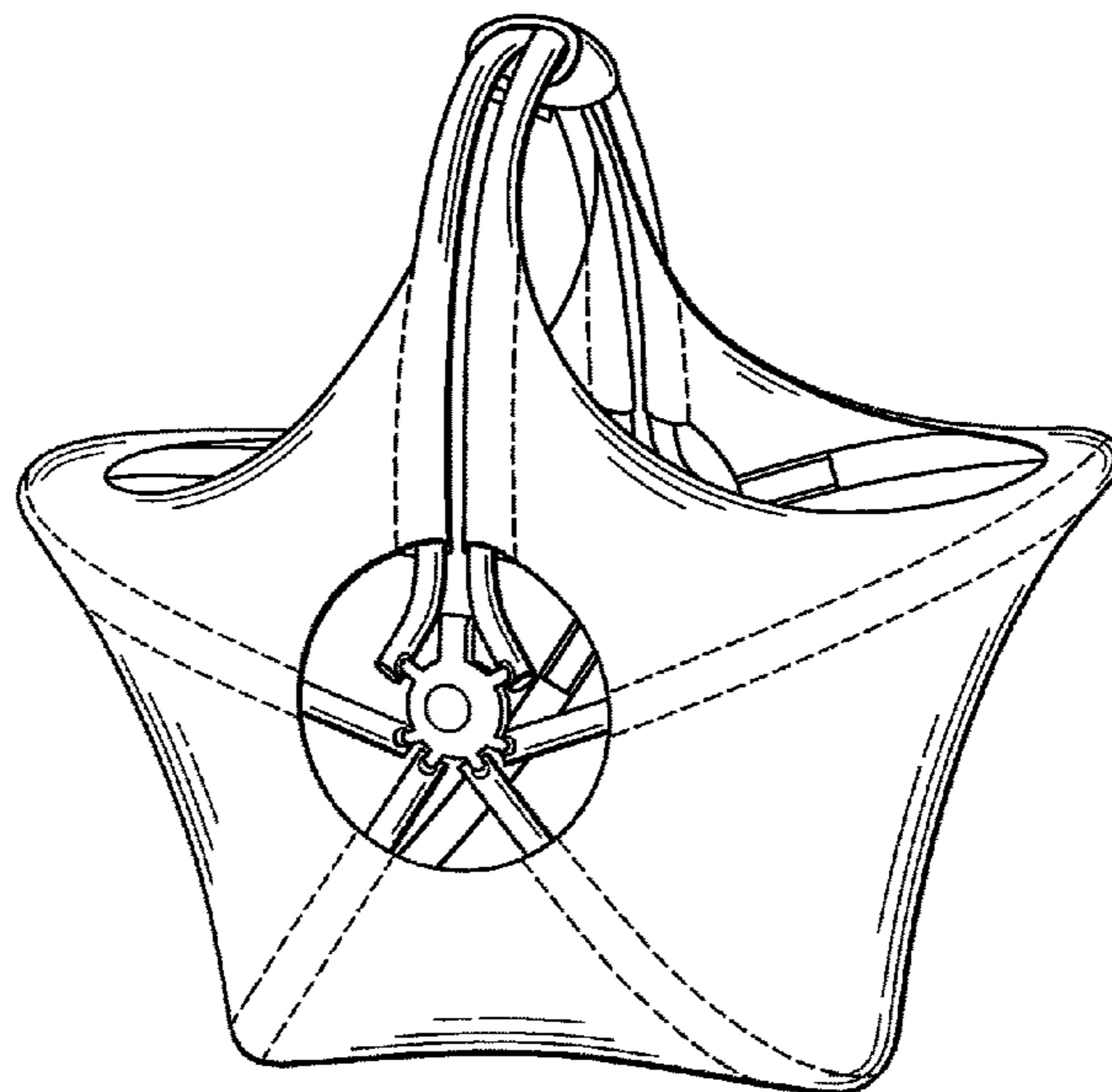
The broken lines are included for the purpose of illustrating  
environmental structure and form no part of the claimed  
design.

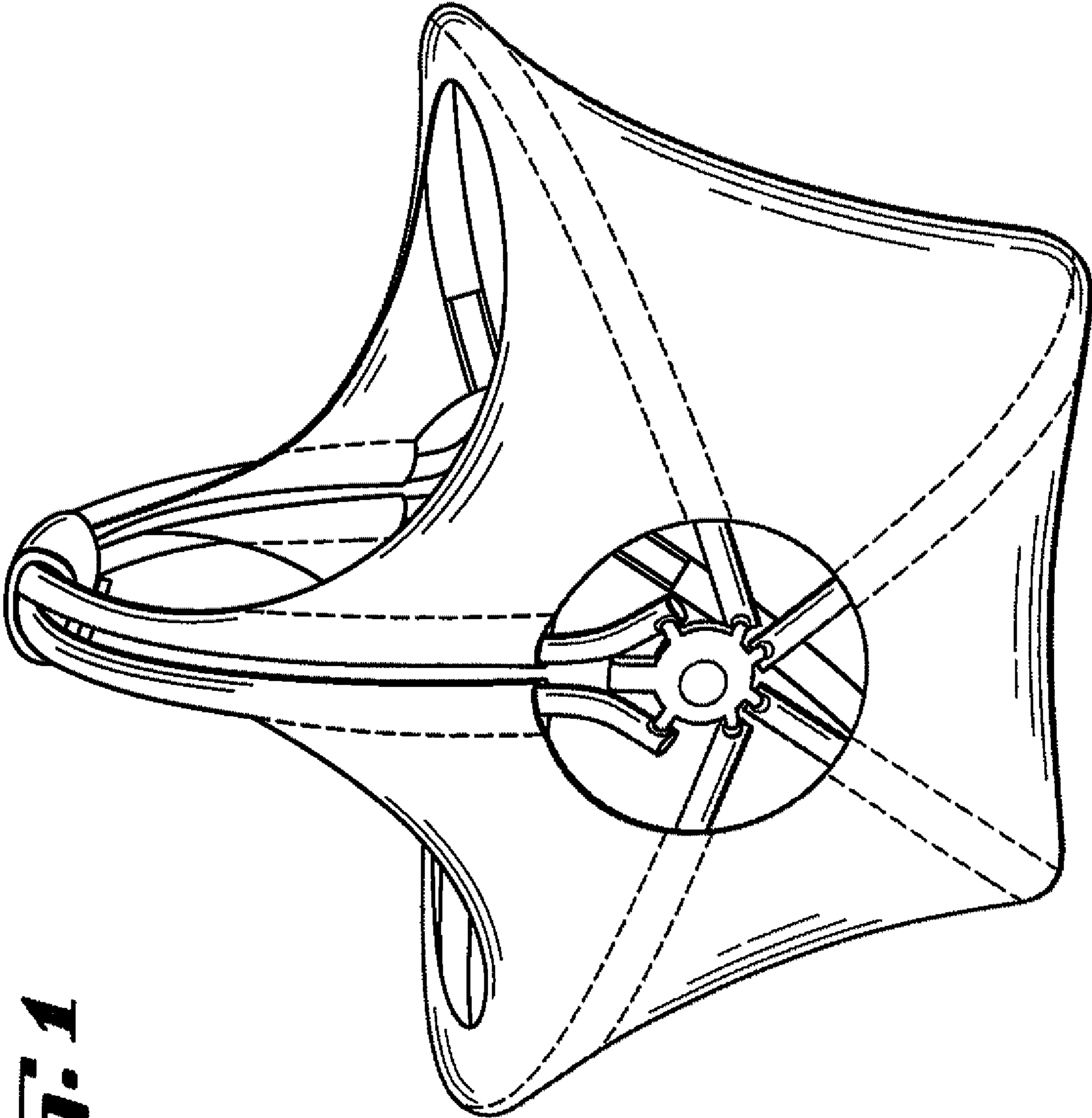
(56) **References Cited**

**U.S. PATENT DOCUMENTS**

1,757,168	A *	5/1930	Brunell	.....	220/9.3
1,906,173	A *	4/1933	Miller	.....	220/9.2
1,906,174	A *	4/1933	Miller	.....	220/9.2
2,020,766	A *	11/1935	Brown	.....	280/639
2,030,204	A *	2/1936	Gray	.....	220/9.2
2,042,977	A *	6/1936	Ahlmark et al.	.....	220/9.3
2,224,537	A *	12/1940	Cowan	.....	220/9.2
2,228,248	A *	1/1941	Ahlmark	.....	220/9.3
2,512,101	A *	6/1950	Hack	.....	220/9.3
2,558,995	A *	7/1951	Tullis	.....	190/8
2,638,399	A *	5/1953	Seymour	.....	312/297
3,306,329	A *	2/1967	Braun	.....	220/9.2
4,723,371	A *	2/1988	Williams	.....	43/1
5,800,067	A *	9/1998	Easter	.....	383/104

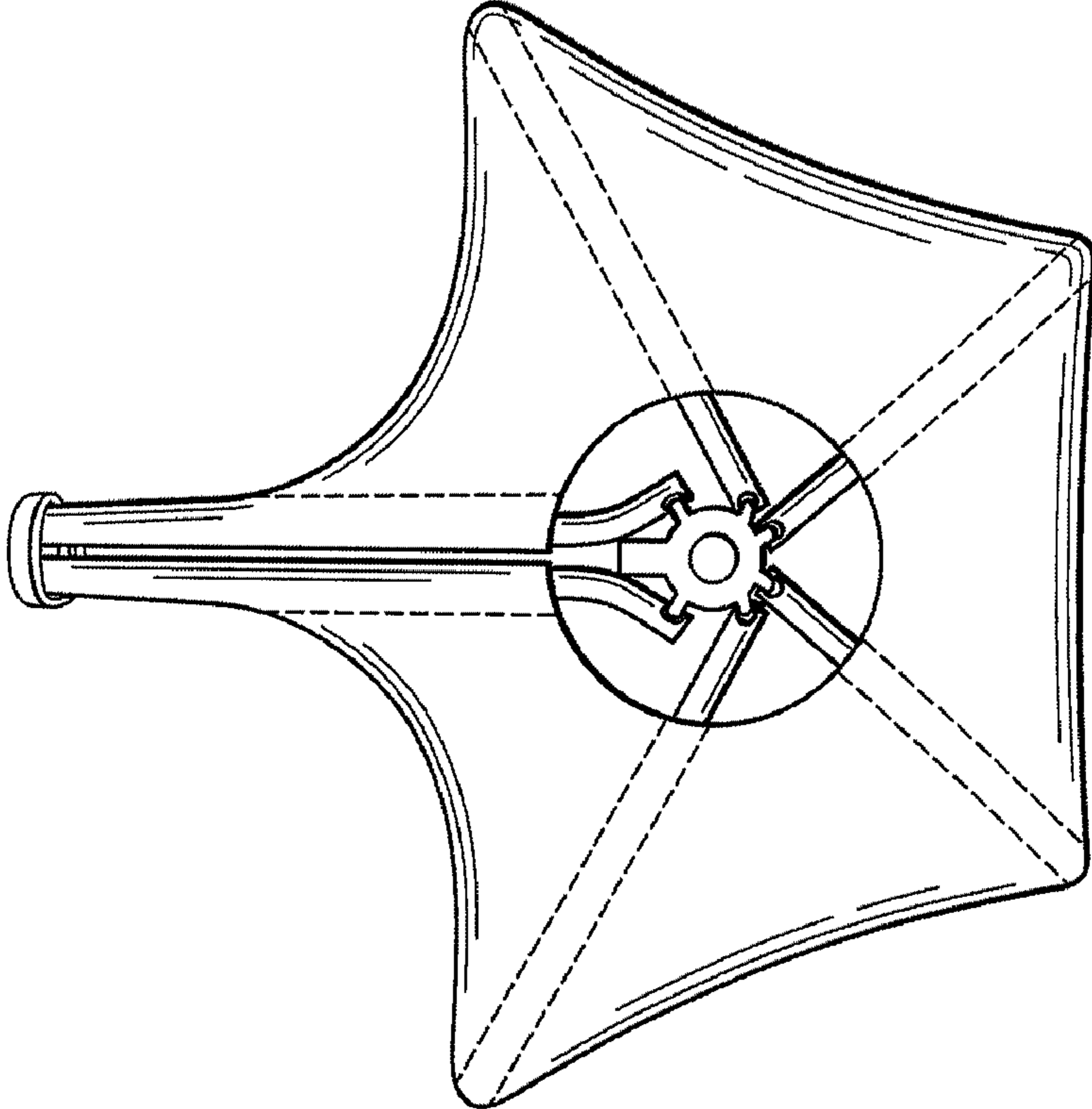
**1 Claim, 6 Drawing Sheets**



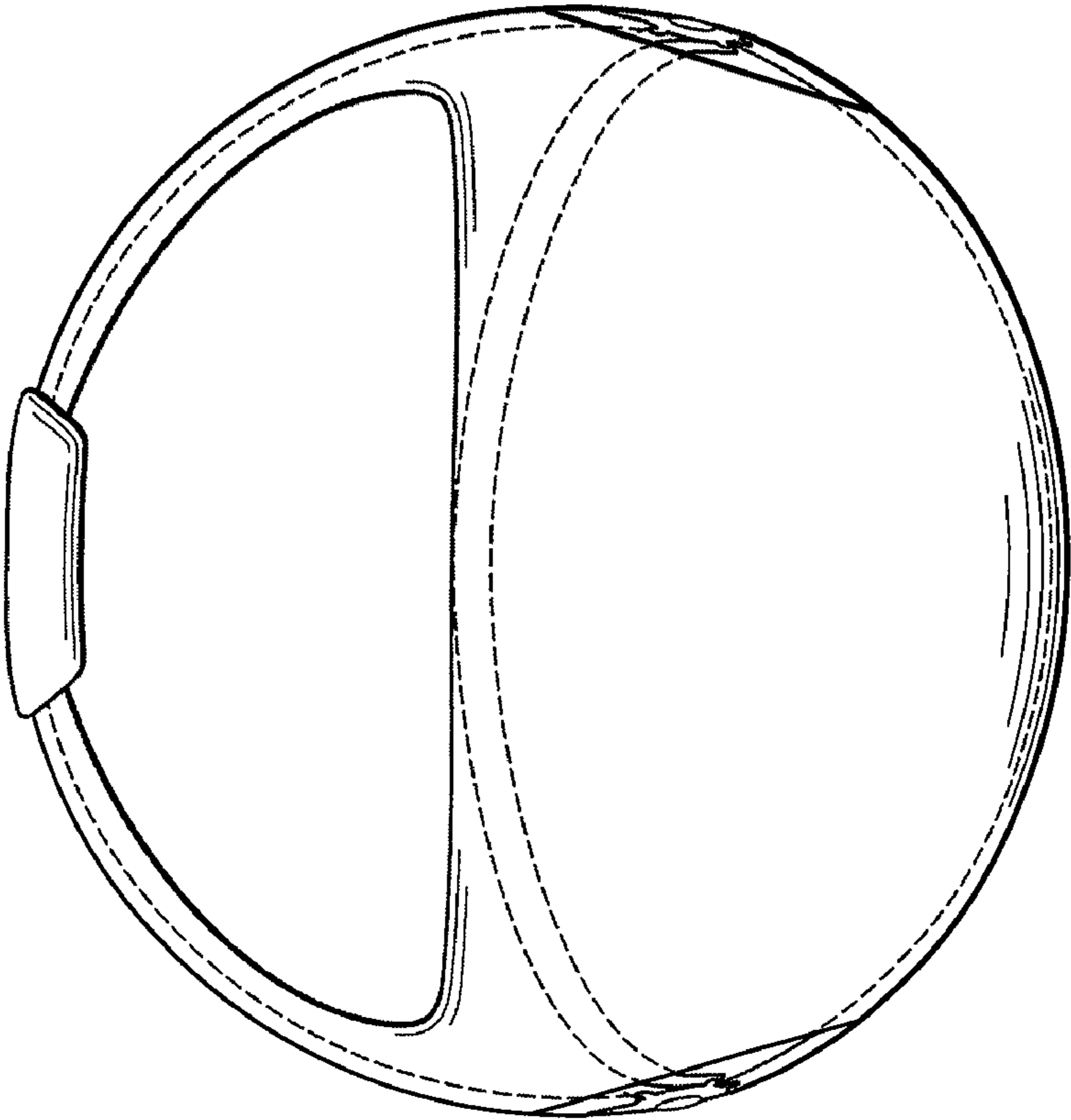


**Fig. 1**

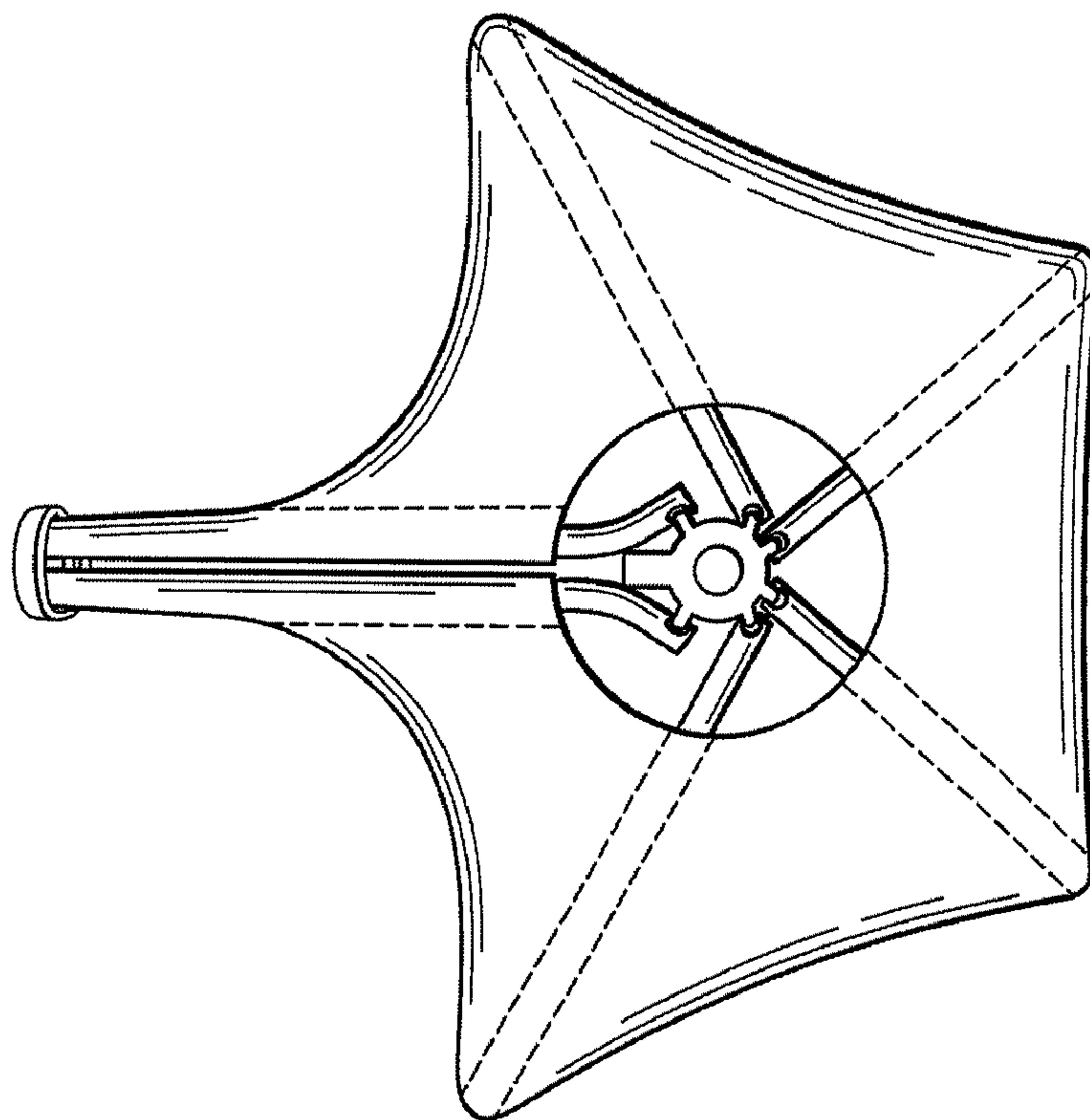
**Fig. 3**



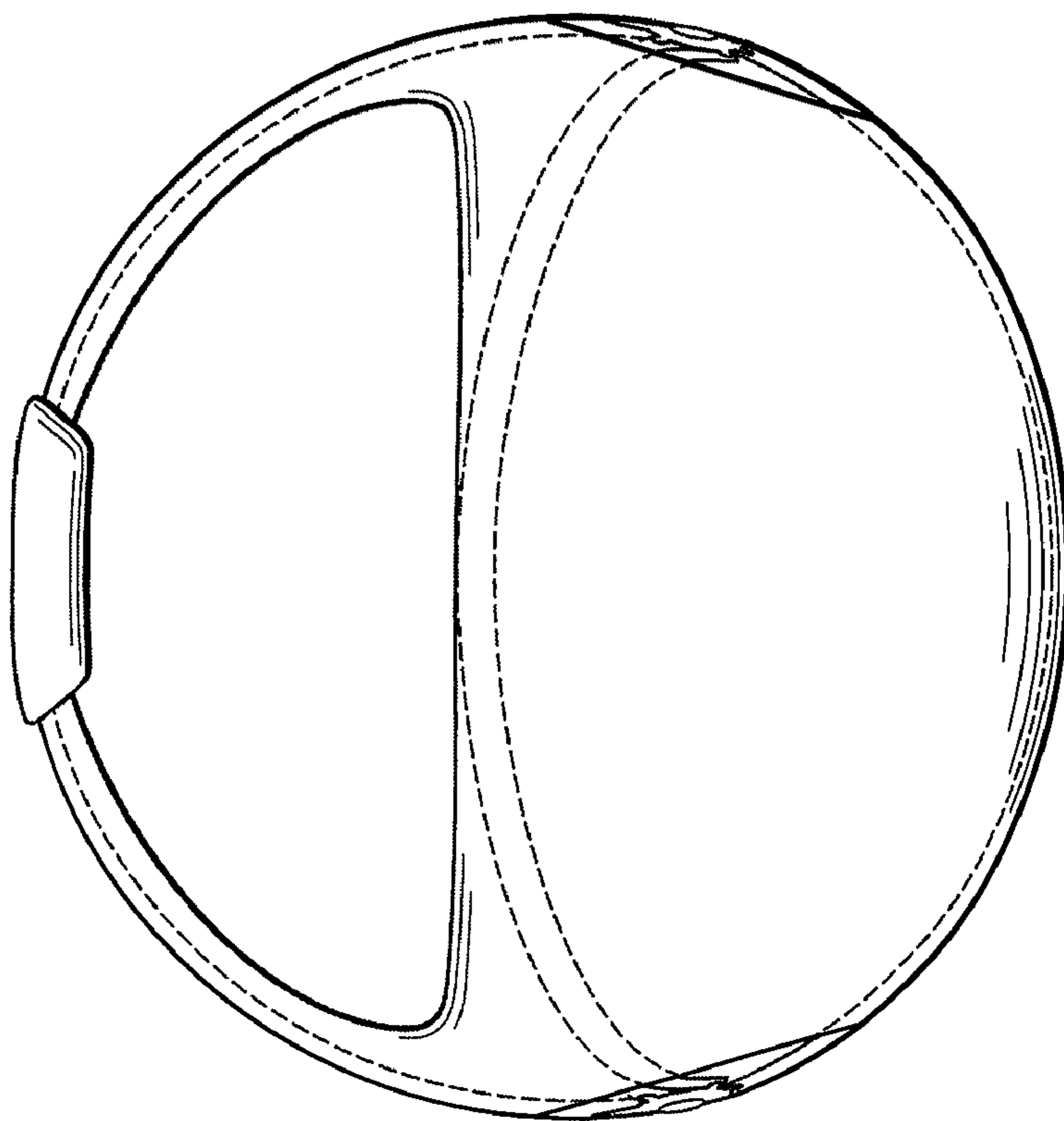
**Fig. 2**



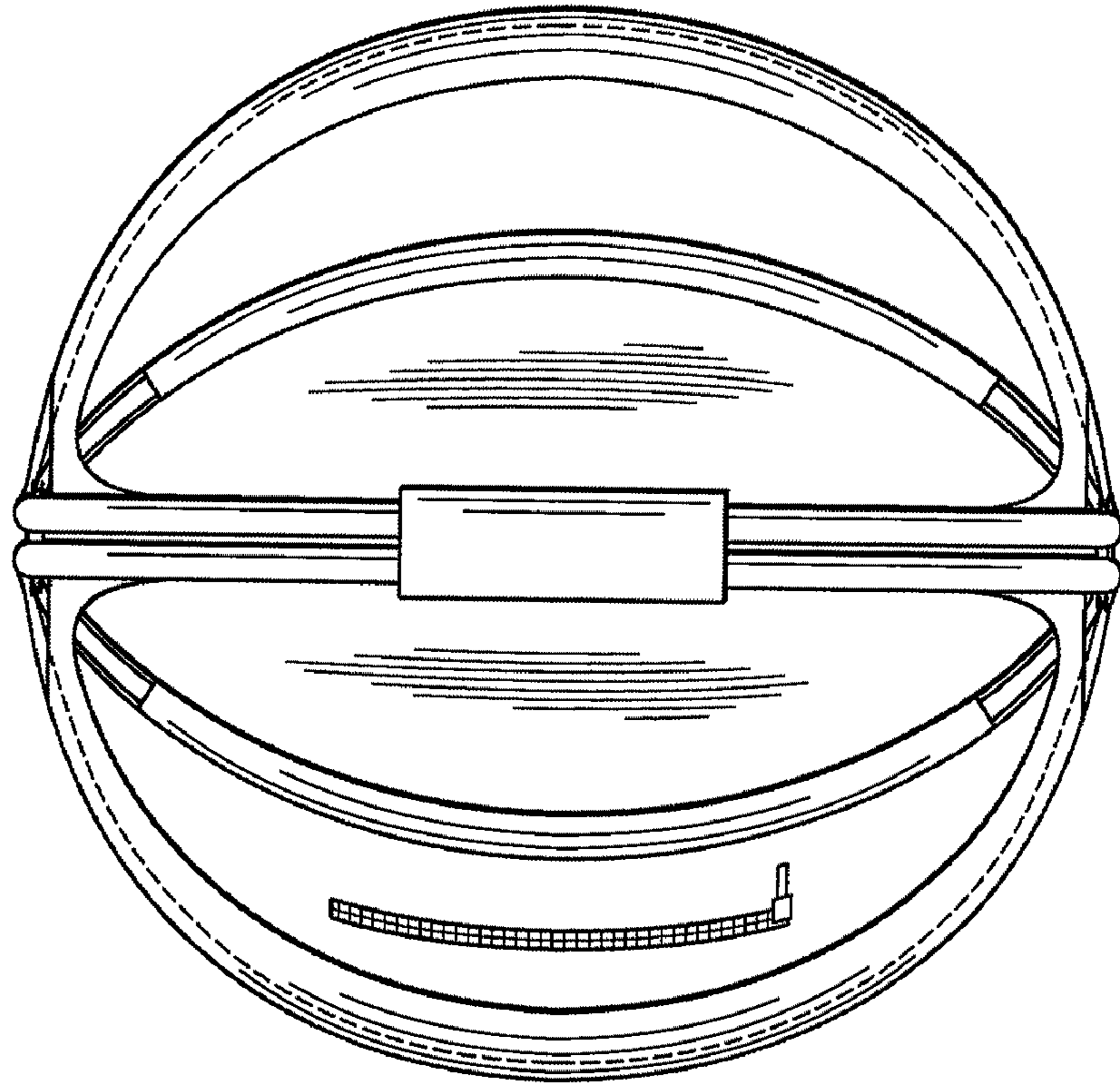
**Fig. 5**



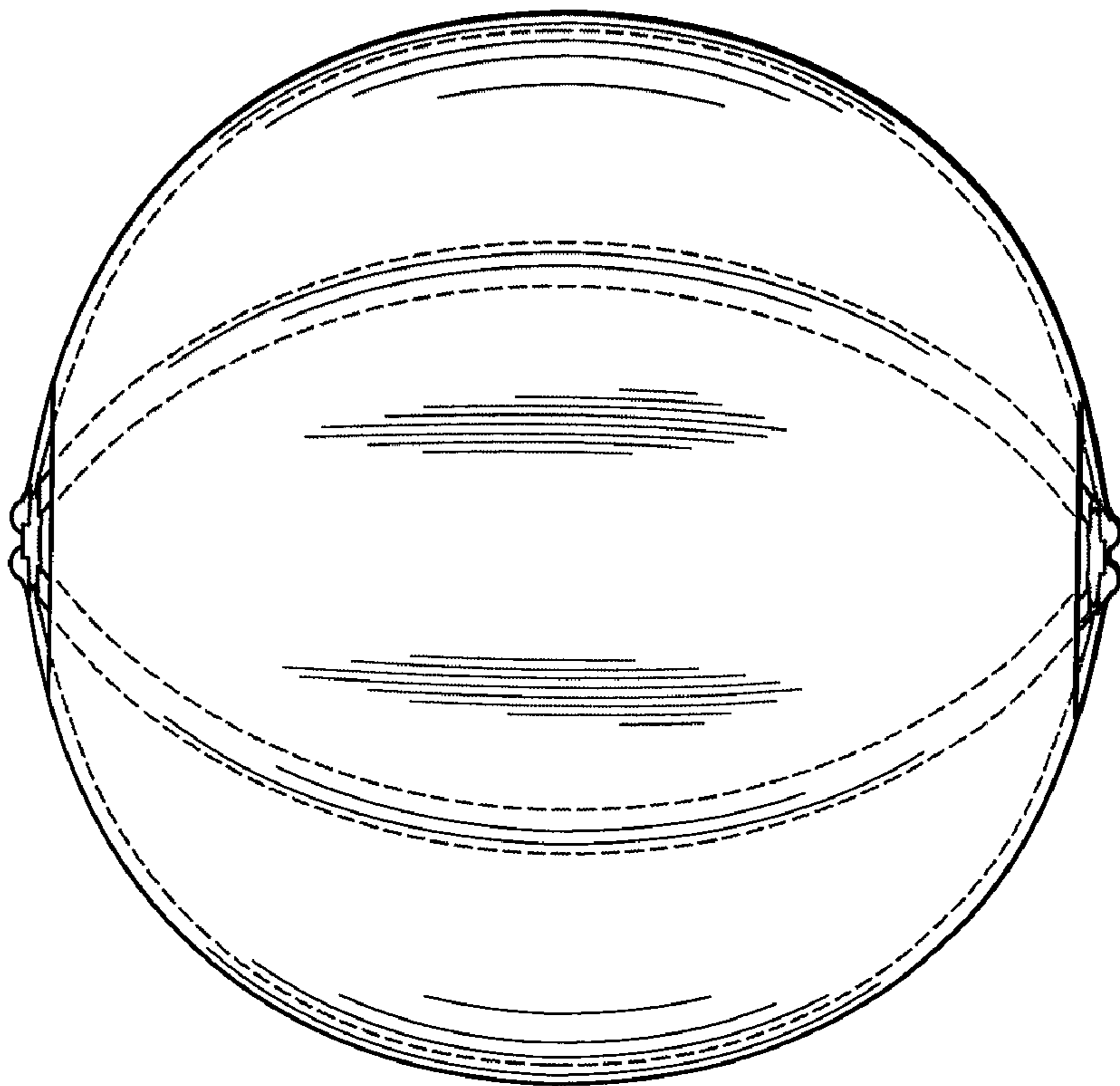
**Fig. 4**



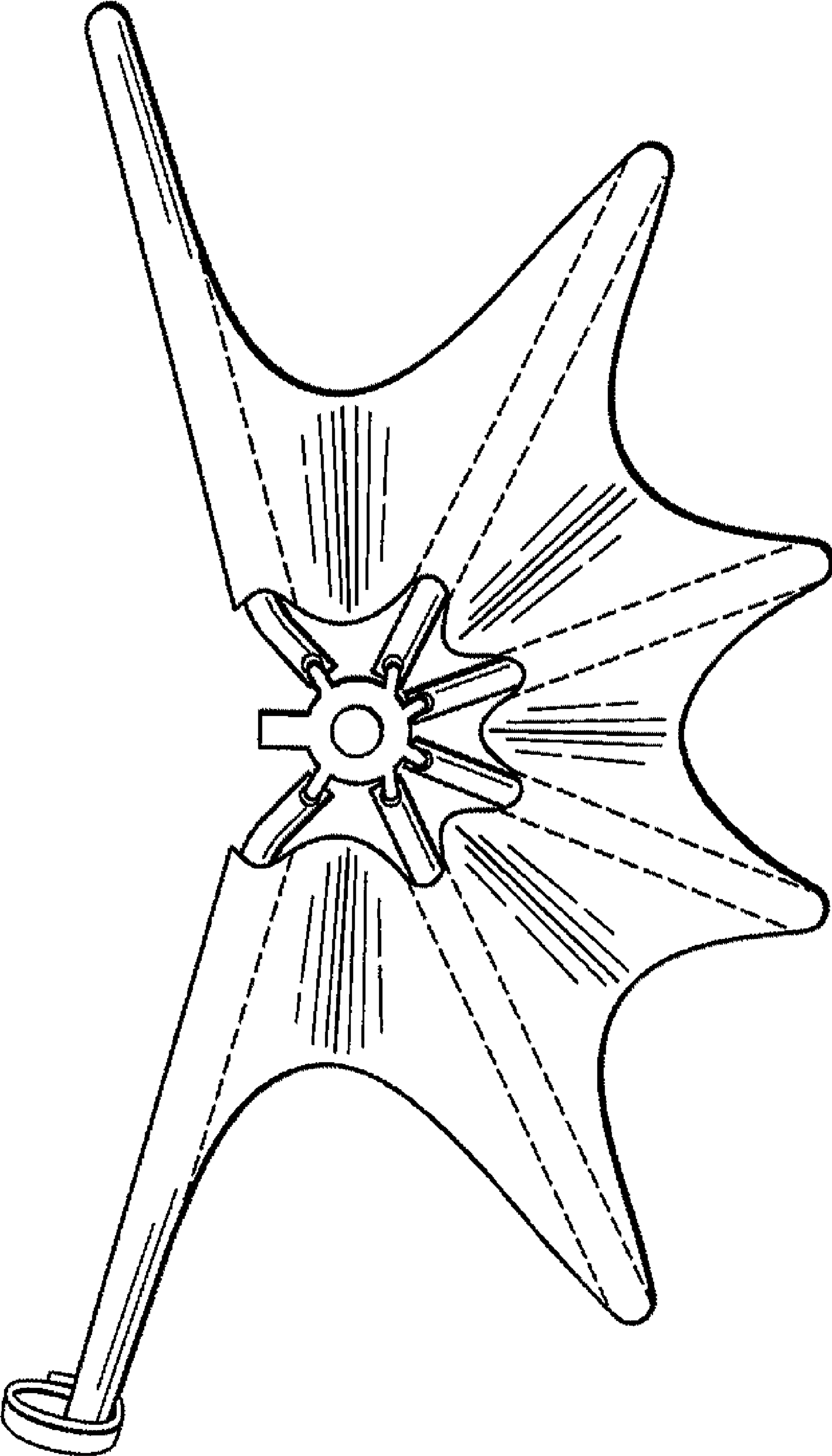
**Fig. 7**



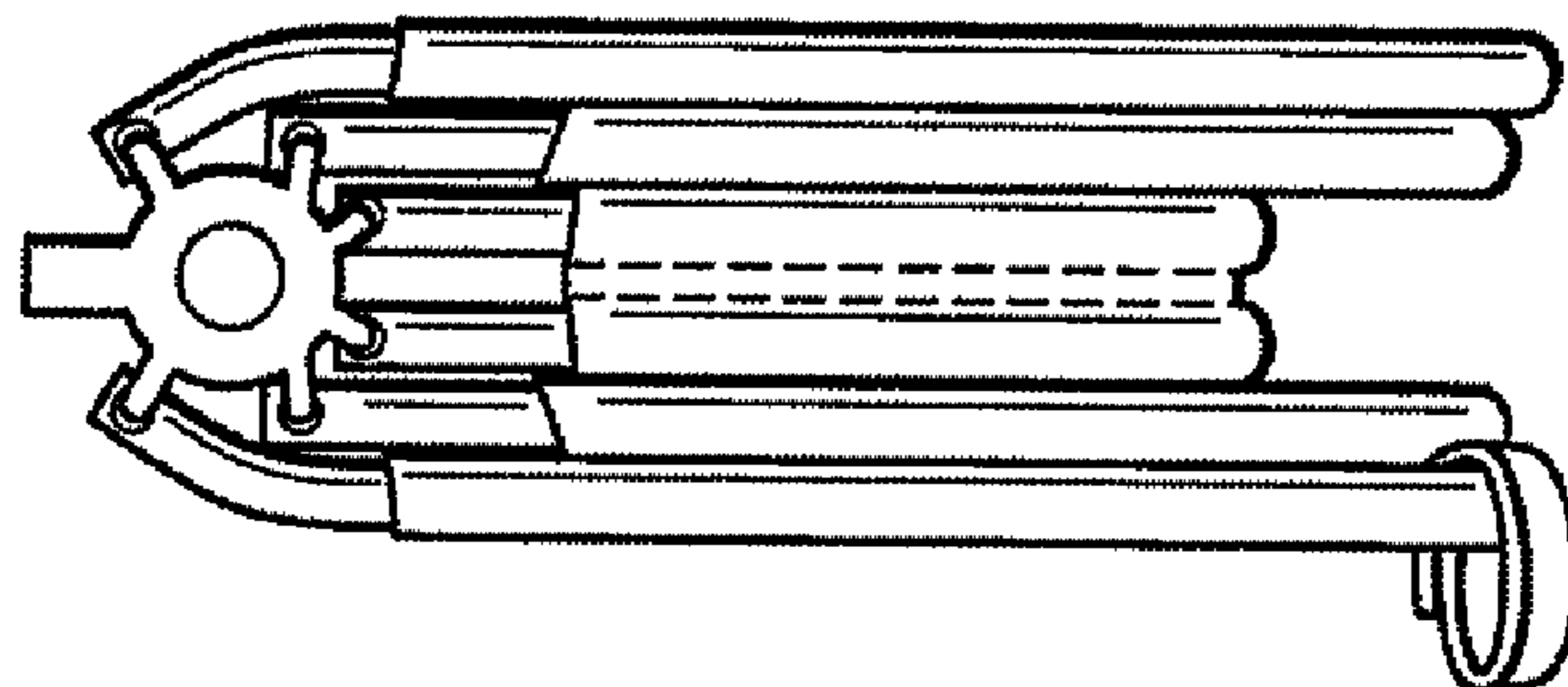
**Fig. 6**



**Fig. 8**



**Fig. 10**



**Fig. 9**

