

US00D616200S

(12) **United States Design Patent**  
**Riedel et al.**

(10) **Patent No.:** **US D616,200 S**

(45) **Date of Patent:** **\*\* May 25, 2010**

(54) **STORAGE BOX**

(75) Inventors: **Robert Byriell Riedel**, Horsens (DK);  
**Søren X. Frahm**, Horsens (DK)

(73) Assignee: **Raaco International A/S**, Nykøbing F (DK)

(\*\*) Term: **14 Years**

(21) Appl. No.: **29/325,628**

(22) Filed: **Oct. 3, 2008**

(30) **Foreign Application Priority Data**

Apr. 7, 2008 (EM) ..... 000909965-0005

(51) **LOC (9) Cl.** ..... **03-01**

(52) **U.S. Cl.** ..... **D3/281; D3/295; D3/905**

(58) **Field of Classification Search** ..... D3/273,  
D3/276, 282, 294–297, 905, 260, 281; 206/349,  
206/372–373, 315.11

See application file for complete search history.

(56) **References Cited**

**U.S. PATENT DOCUMENTS**

D232,492	S	*	8/1974	Barecki	.....	D3/282
4,344,646	A	*	8/1982	Michel	.....	292/87
D269,648	S	*	7/1983	Wilcox et al.	.....	D3/282
D314,669	S	*	2/1991	Kunimune	.....	D3/282
D358,257	S	*	5/1995	Sidabras et al.	.....	D3/282
D369,901	S	*	5/1996	Laube	.....	D3/205
D431,112	S	*	9/2000	Ahern et al.	.....	D3/323

D437,684	S	*	2/2001	Streich et al.	.....	D3/273
D447,634	S	*	9/2001	Snider	.....	D3/294
D448,167	S	*	9/2001	Pangerc et al.	.....	D3/294
D468,688	S	*	1/2003	Helman	.....	D13/119
7,121,407	B2	*	10/2006	Hurt et al.	.....	206/373
7,357,250	B2	*	4/2008	Hagemann et al.	.....	206/315.11

\* cited by examiner

*Primary Examiner*—Philip S Hyder

*Assistant Examiner*—Roselynn Cody

(74) *Attorney, Agent, or Firm*—St. Onge Steward Johnston & Reens LLC

(57) **CLAIM**

The ornamental design for a storage box, as shown and described.

**DESCRIPTION**

FIG. 1 is a front, top and right side perspective view of a storage box in a closed position;

FIG. 2 is a top plan view thereof;

FIG. 3 is a bottom plan view thereof;

FIG. 4 is a rear, bottom, and left side perspective view;

FIG. 5 is a front, top and right side perspective view of the storage box of FIG. 1 in an open position; and,

FIG. 6 is a top plan view thereof.

The broken lines in FIGS. 3 and 6 illustrate aspects of the design that form no part of the claim.

**1 Claim, 6 Drawing Sheets**

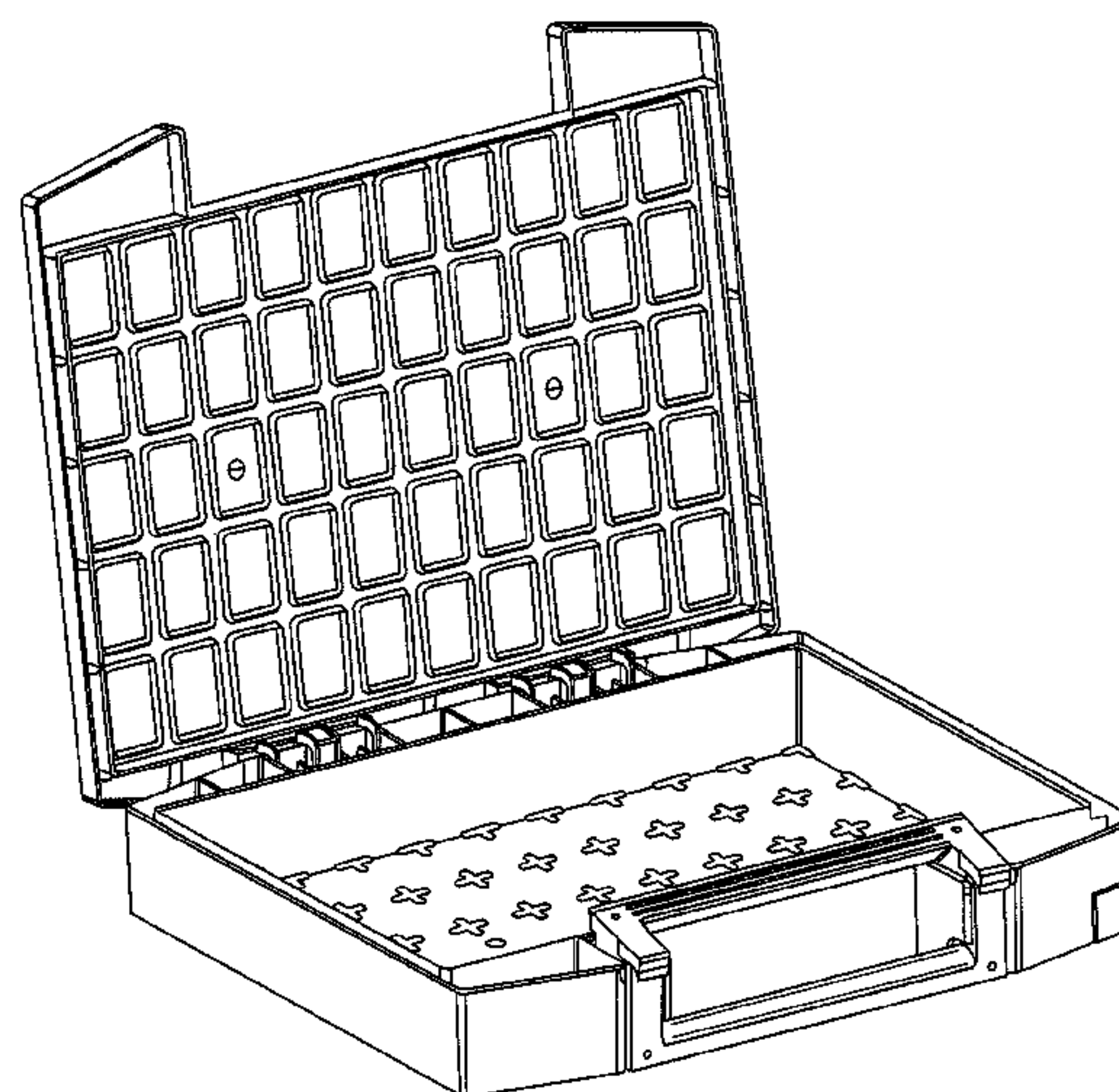
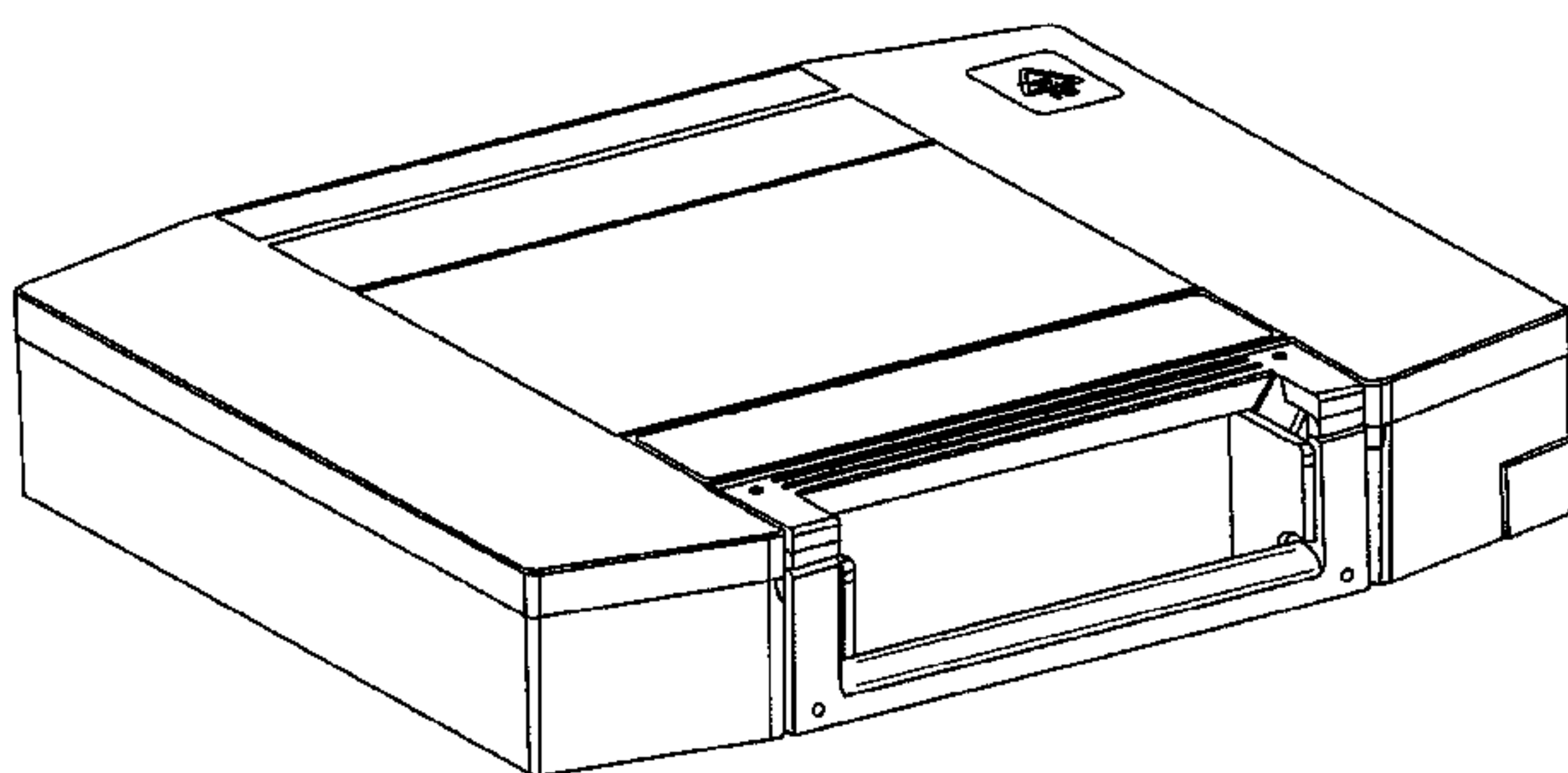

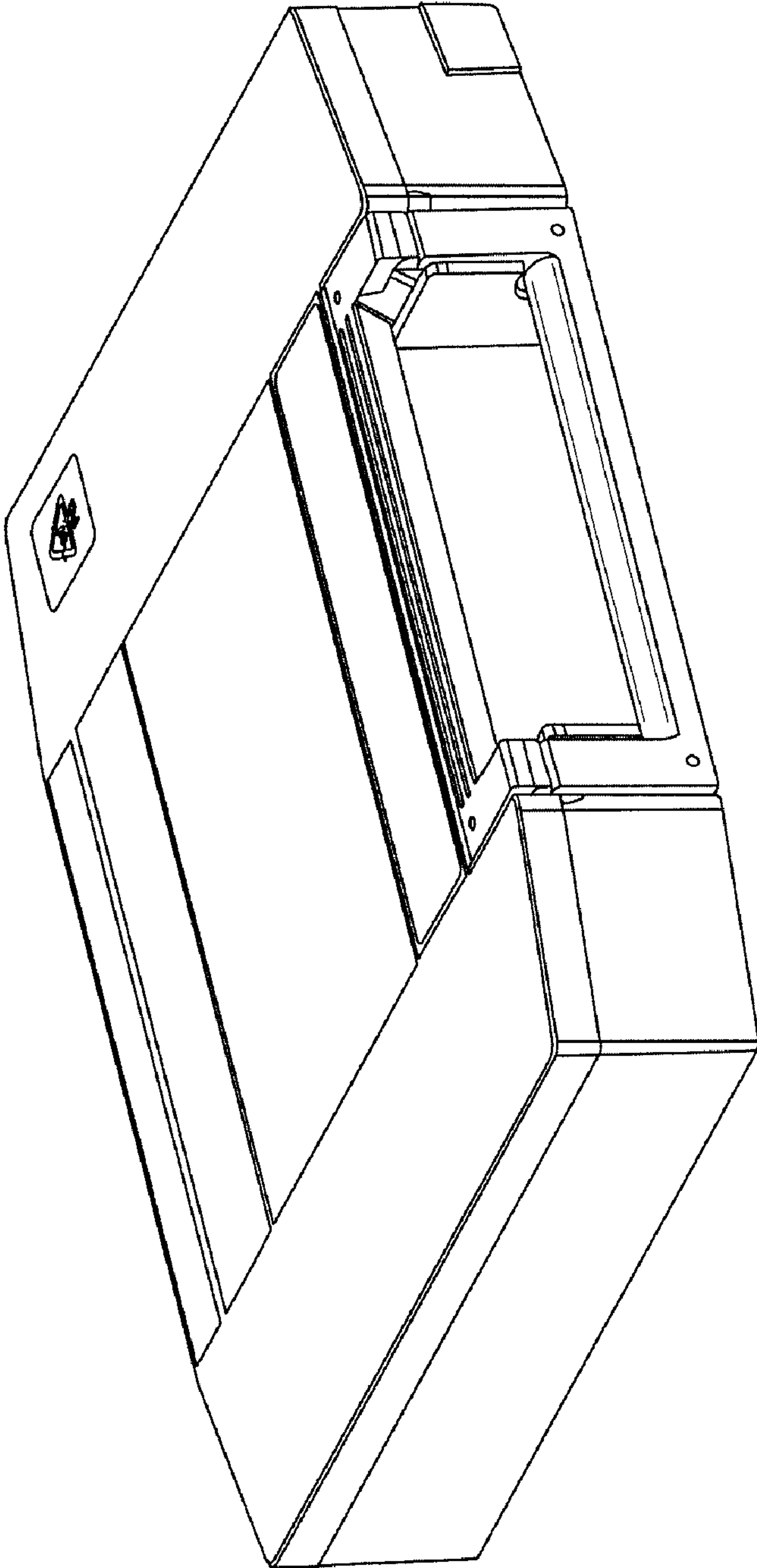

**FIG. 1**

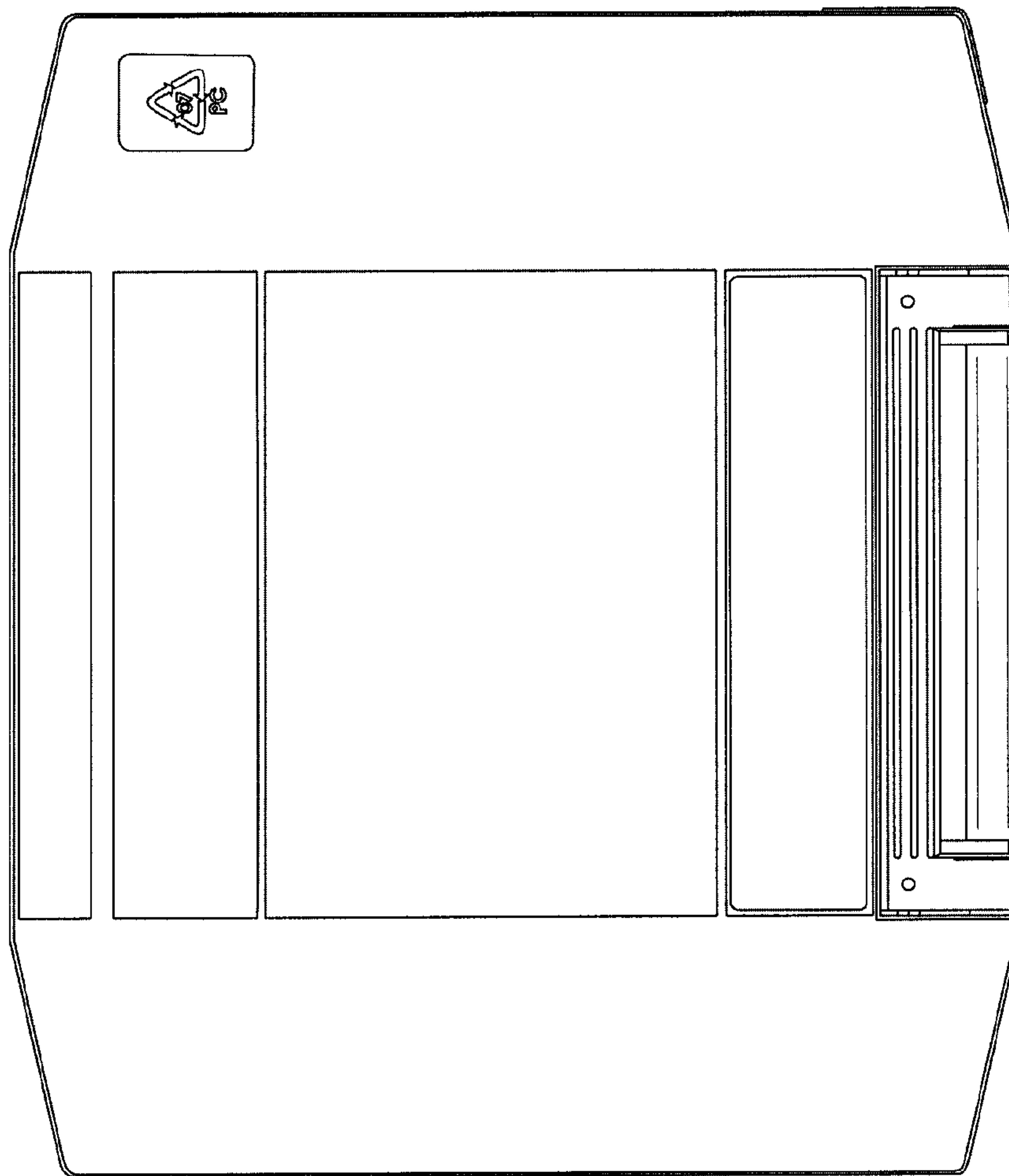

FIG. 2

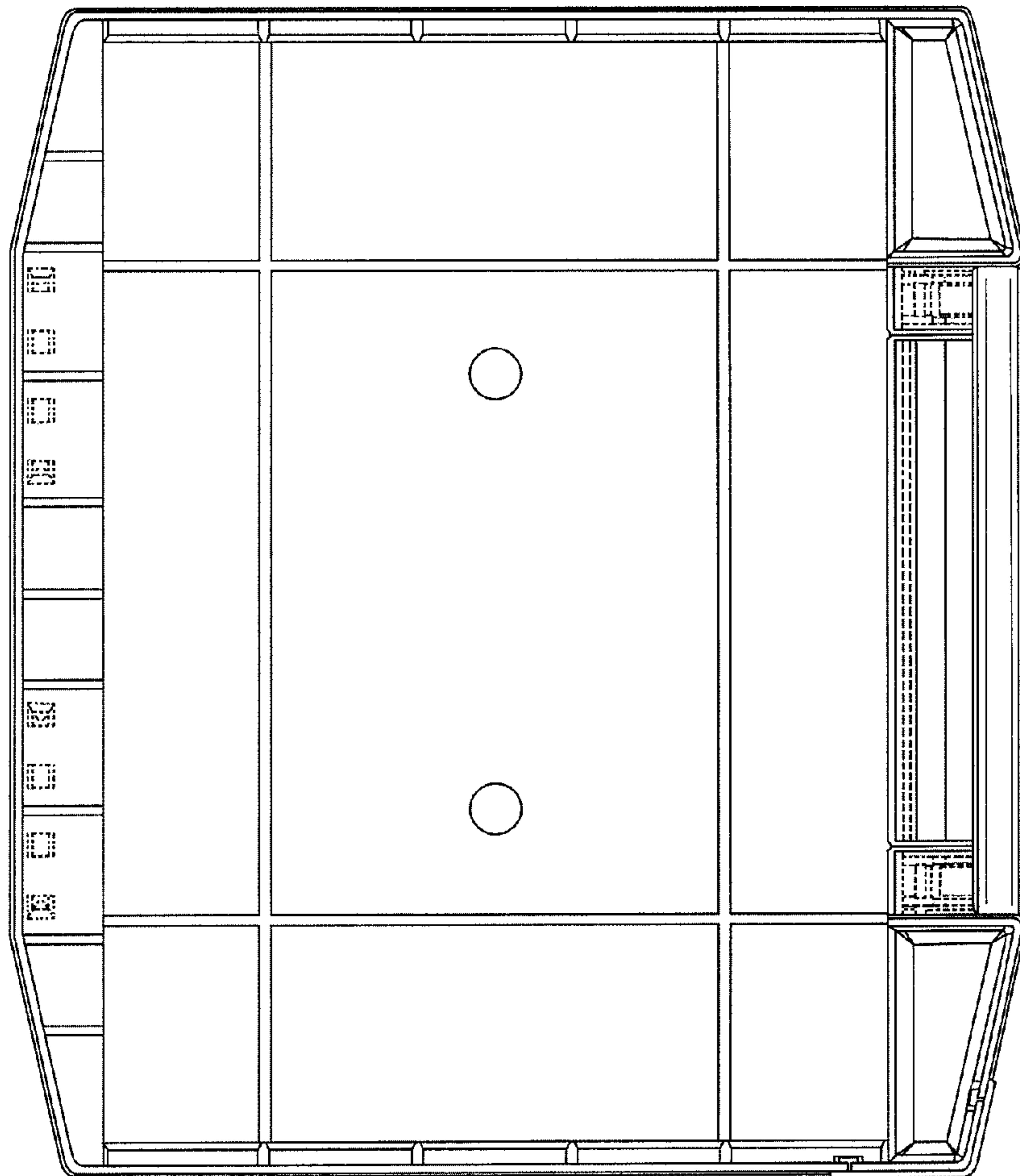
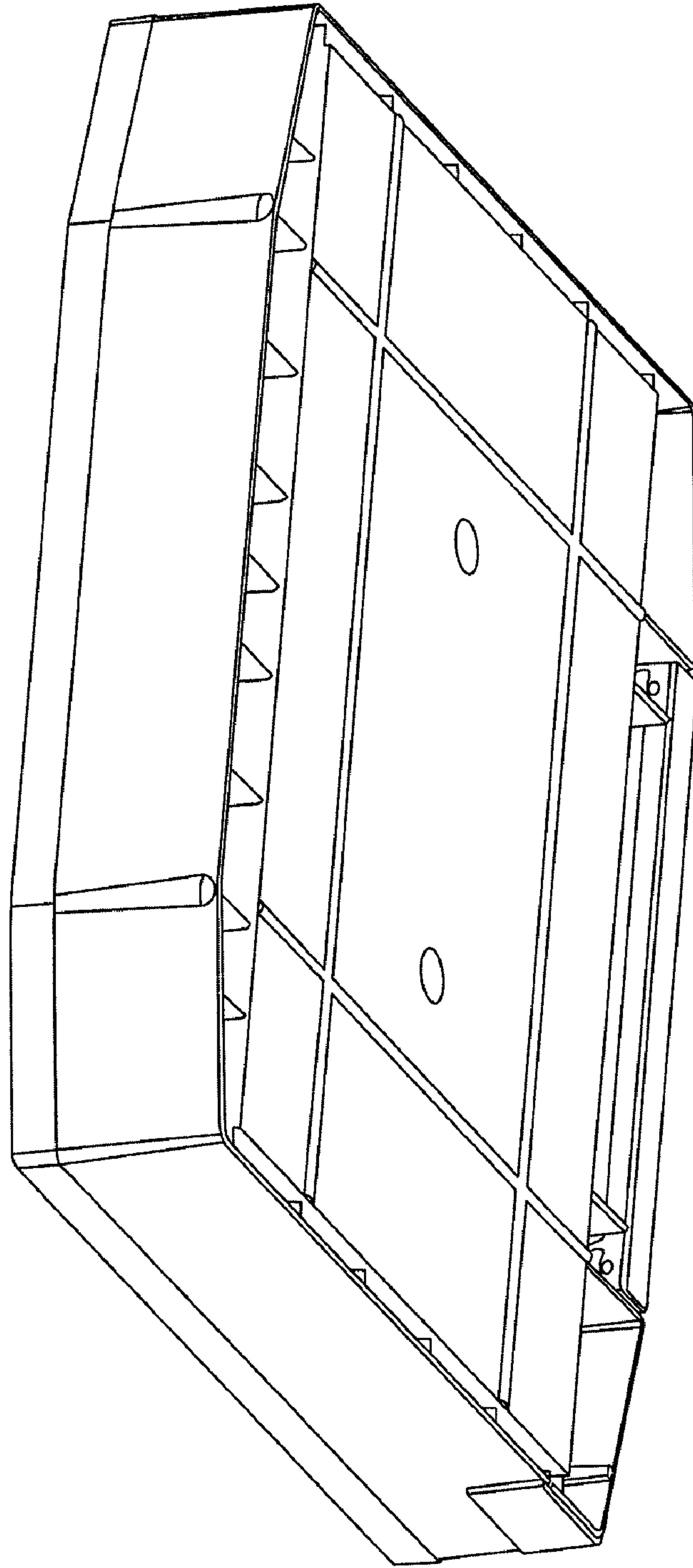

FIG. 3



**FIG. 4**



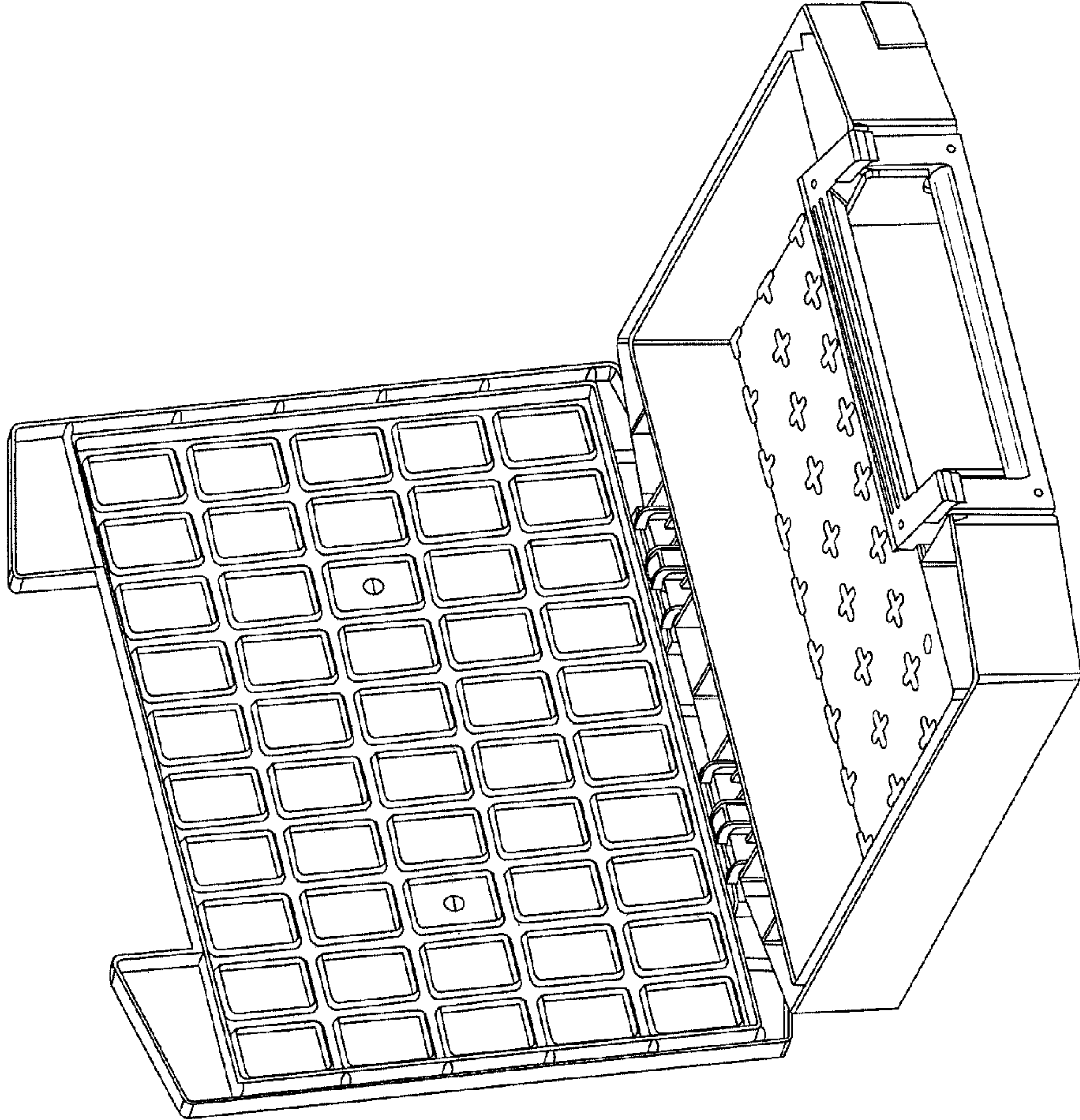

FIG. 5

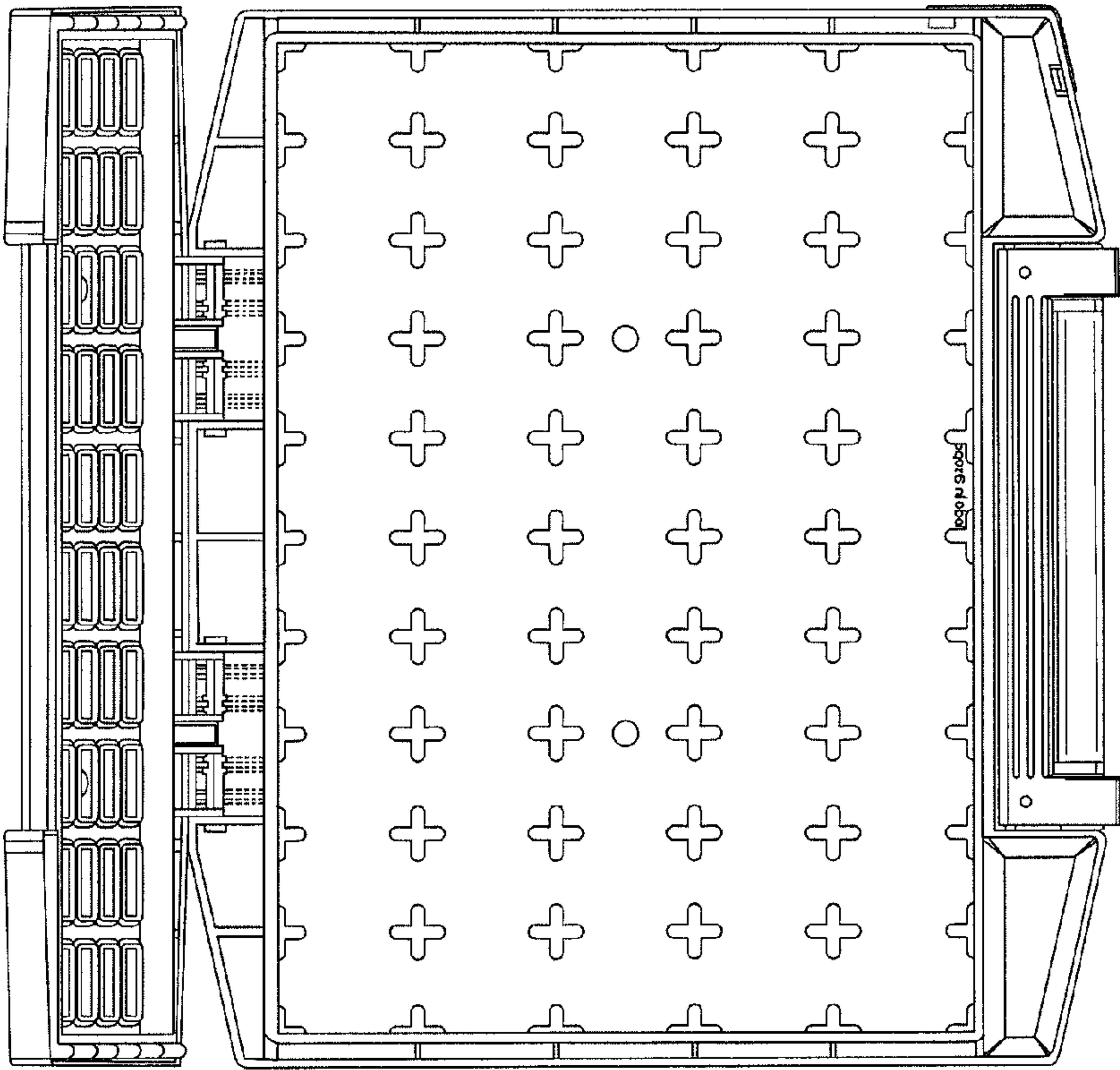

FIG. 6