



US00D616181S

(12) **United States Design Patent**  
**Harada et al.**

(10) **Patent No.:** **US D616,181 S**  
(45) **Date of Patent:** **\*\* May 25, 2010**

(54) **ADJUSTMENT STRAP**

(75) Inventors: **Takeshi Harada**, Tokyo (JP); **Yasutaka Nishida**, Tokyo (JP); **Hisanori Kato**, Tokyo (JP)

(73) Assignee: **YKK Corporation**, Tokyo (JP)

(\*\*) Term: **14 Years**

(21) Appl. No.: **29/346,680**

(22) Filed: **Nov. 4, 2009**

(30) **Foreign Application Priority Data**

May 7, 2009 (JP) ..... 2009-010280

(51) **LOC (9) Cl.** ..... **02-03**

(52) **U.S. Cl.** ..... **D2/891**

(58) **Field of Classification Search** ..... D2/865,  
D2/875, 876, 878, 879, 882, 884, 886, 891;  
D11/200; D29/122; 2/171, 183, 184.5, 175.1,  
2/195.1, 195.2, 209.12, 209.13, 417, 418,  
2/421; 24/593.1, 593.11

See application file for complete search history.

(56) **References Cited**

**U.S. PATENT DOCUMENTS**

614,962 A \* 11/1898 Landauer ..... 2/171.5  
829,818 A \* 8/1906 Webb ..... 2/209.4  
1,237,048 A \* 8/1917 Idoux ..... 2/181.8  
1,804,725 A \* 5/1931 Walker ..... 24/20 TT  
1,887,825 A \* 11/1932 Statham ..... 24/68 E  
4,393,548 A \* 7/1983 Herb ..... 24/16 PB  
4,999,846 A \* 3/1991 Ball et al. .... 2/5  
5,077,839 A \* 1/1992 Keller ..... 2/421  
D324,193 S \* 2/1992 Wen-Long ..... D11/220

5,203,034 A \* 4/1993 Foehl ..... 2/421  
D362,741 S \* 10/1995 Hollinger ..... D2/639  
5,752,298 A \* 5/1998 Howell ..... 24/593.1  
6,256,847 B1 \* 7/2001 Manley et al. .... 24/593.11  
6,314,587 B1 \* 11/2001 Fang ..... 2/418  
D469,383 S \* 1/2003 Young ..... D11/200  
D480,327 S 10/2003 Hollinger  
6,701,535 B2 \* 3/2004 Dobbie et al. .... 2/422  
7,036,156 B2 \* 5/2006 Lahman et al. .... 2/181  
7,246,383 B2 \* 7/2007 Musal ..... 2/418  
D568,785 S \* 5/2008 Yang et al. .... D11/218

\* cited by examiner

*Primary Examiner*—Elizabeth A Albert

*Assistant Examiner*—Karen E Eldridge Powers

(74) *Attorney, Agent, or Firm*—Alston & Bird, LLP

(57) **CLAIM**

The ornamental design for a adjustment strap, as shown and described.

**DESCRIPTION**

FIG. 1 is a perspective view of the top, front and left side of a adjustment strap showing our new design;

FIG. 2 is front view thereof;

FIG. 3 is a rear view thereof;

FIG. 4 is a right side view thereof,

FIG. 5 is a left side view thereof;

FIG. 6 is a top plan view thereof; and,

FIG. 7 is a perspective view of the usage thereof.

The portions of the article in broken lines are shown for illustrative purposes only and form no part of the claimed design.

**1 Claim, 4 Drawing Sheets**

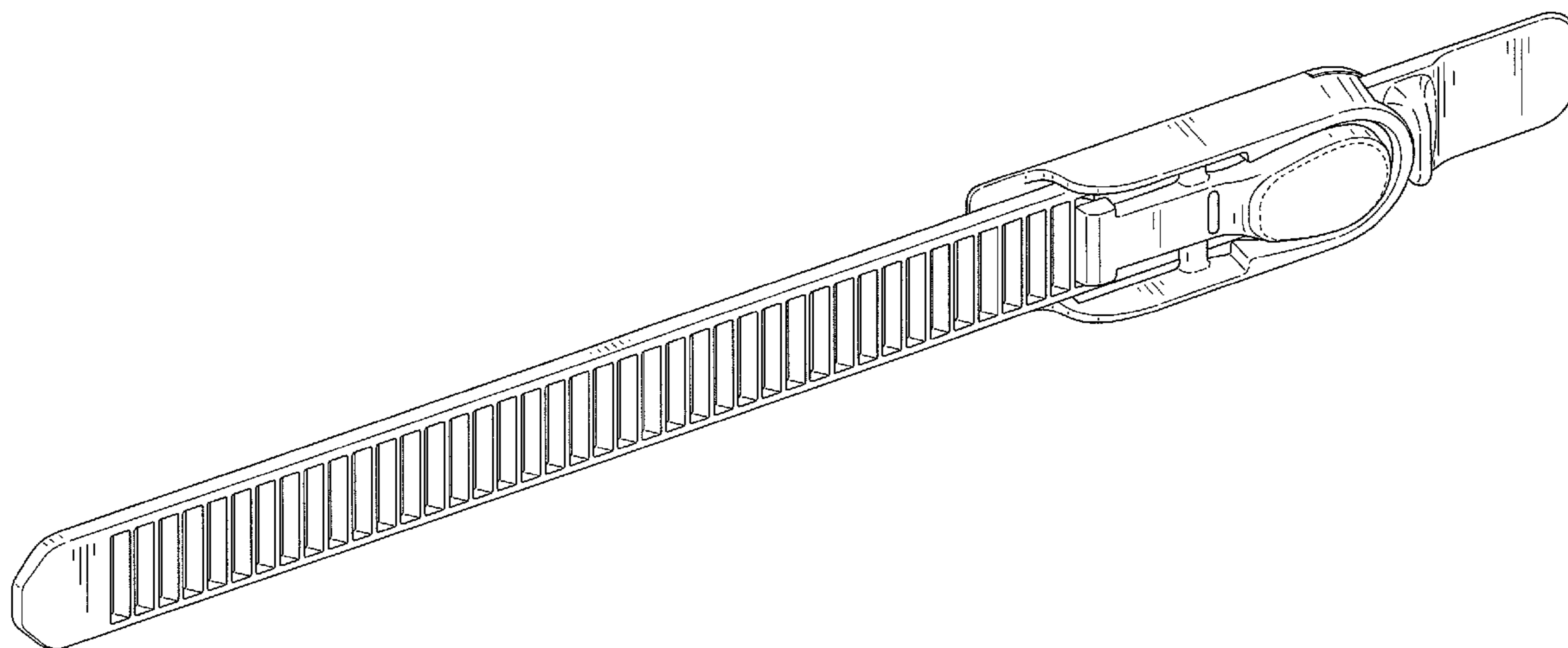

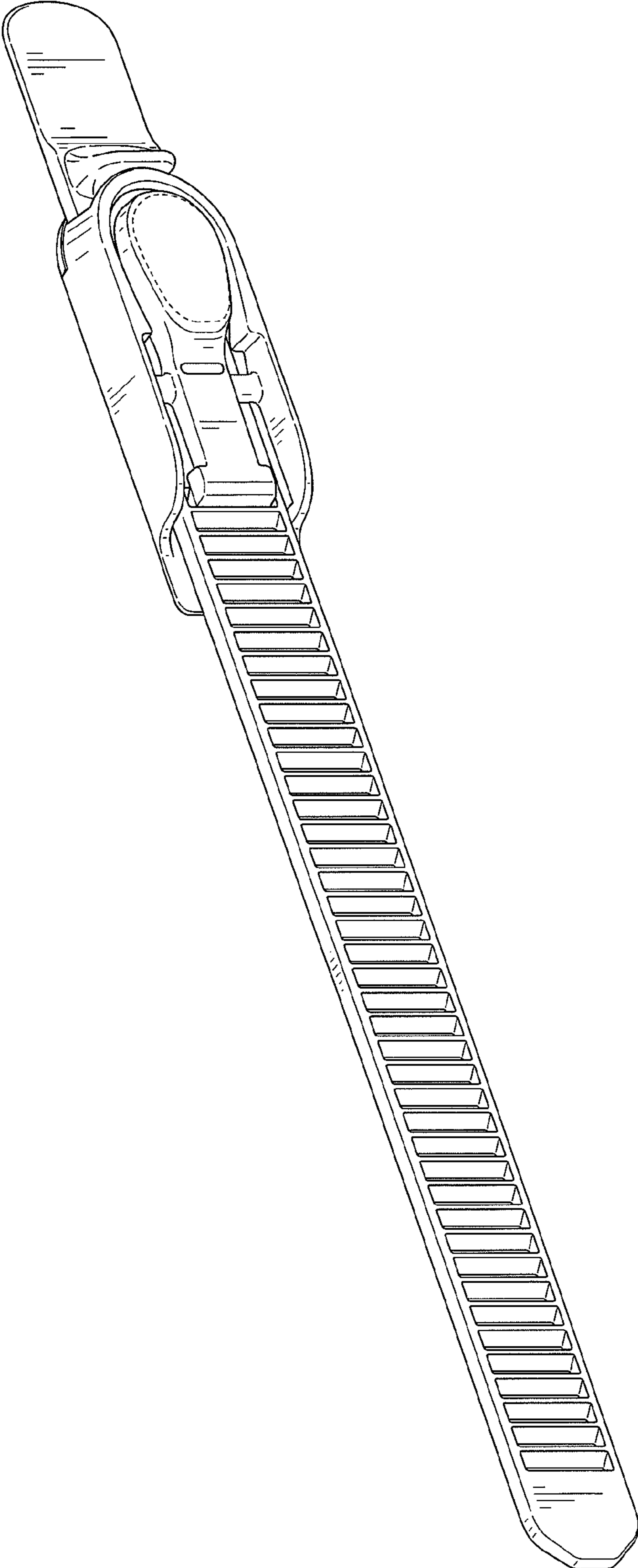

FIG. 1

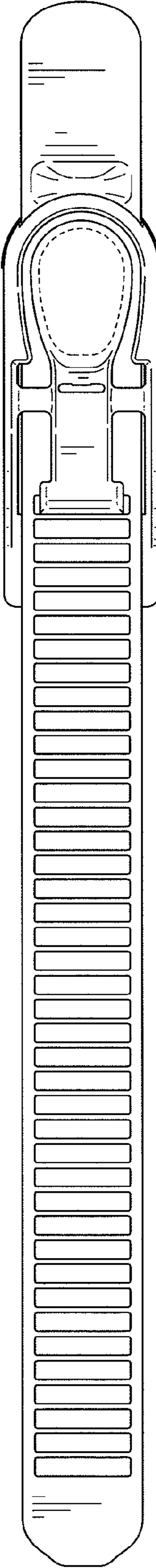

FIG. 2

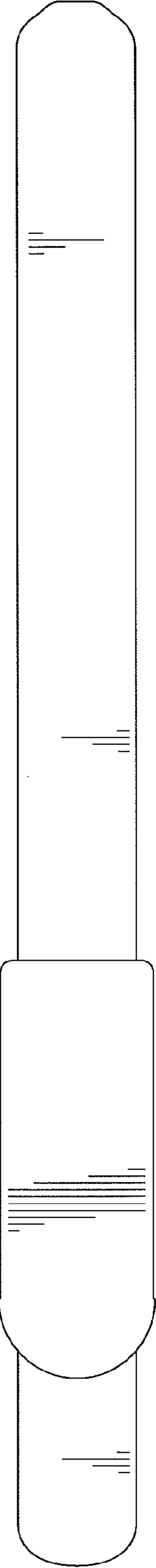

FIG. 3

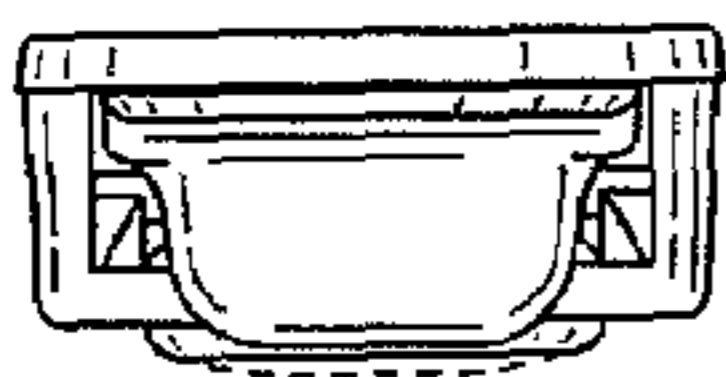

FIG. 5



FIG. 4

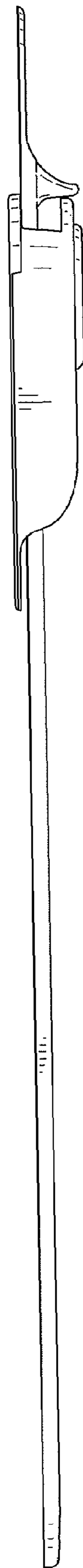

FIG. 6

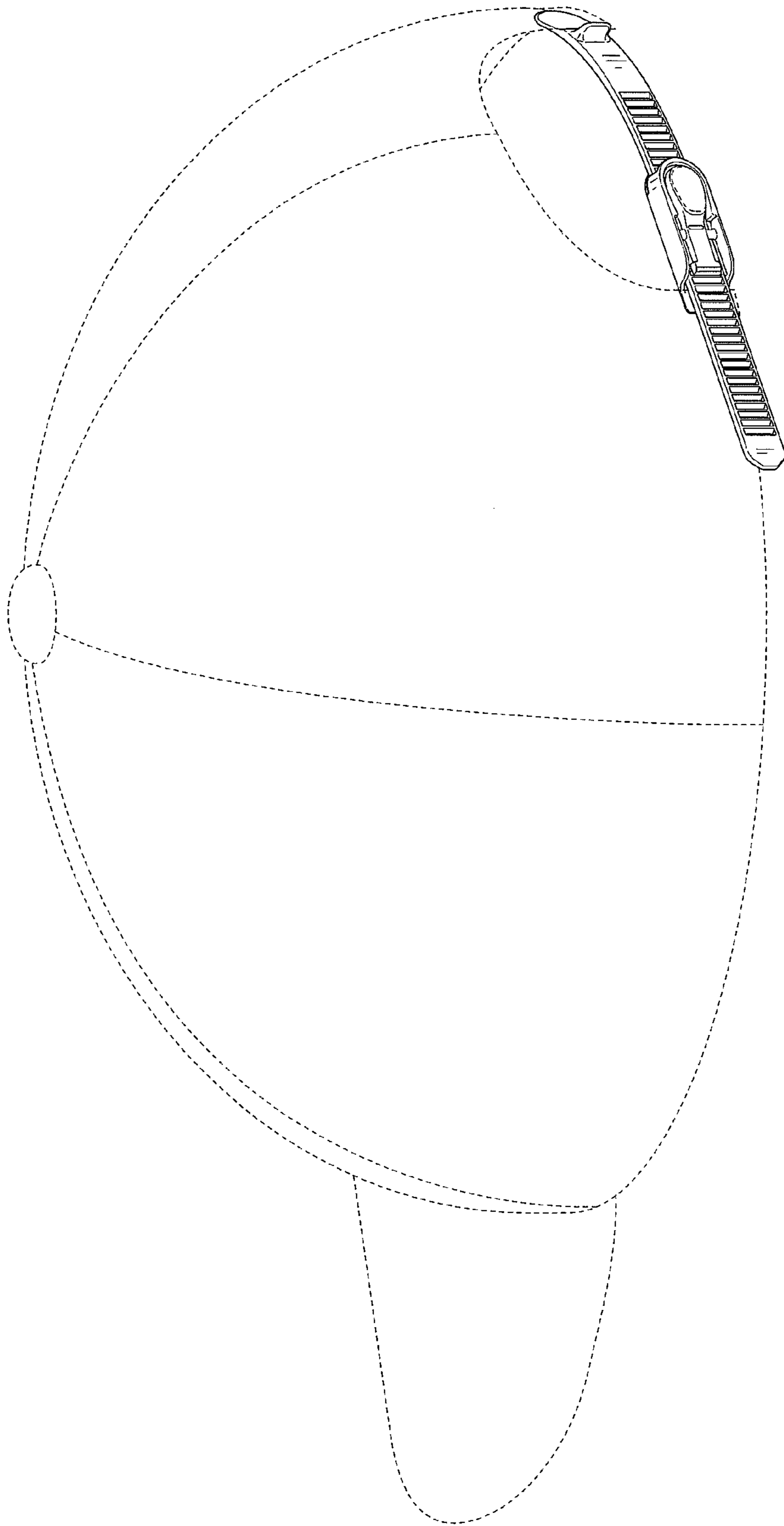

FIG. 7