



US00D616114S

(12) **United States Design Patent**
Harder

(10) **Patent No.:** **US D616,114 S**

(45) **Date of Patent:** **** May 18, 2010**

(54) **DECK POST**

D583,081 S * 12/2008 Ryan D25/126

(76) Inventor: **Willard J. Harder**, 20355 Eaves Way,
Farmington, MN (US) 55024

* cited by examiner

Primary Examiner—Doris Clark
(74) *Attorney, Agent, or Firm*—Richard John Bartz

(**) Term: **14 Years**

(21) Appl. No.: **29/314,407**

(57) **CLAIM**

(22) Filed: **Mar. 30, 2009**

The ornamental design for a deck post, as shown and described.

(51) **LOC (9) Cl.** **25-01**

(52) **U.S. Cl.** **D25/126**

(58) **Field of Classification Search** D25/126,
D25/122, 123; 256/65.01, 65.02, 65.14;
52/832, 843, 851; 405/201, 202, 208

See application file for complete search history.

DESCRIPTION

FIG. 1 is a foreshortened perspective view of the deck post of my design;

FIG. 2 is a foreshortened side elevational view thereof, the opposite side elevational view being a mirror image thereof;

FIG. 3 is a foreshortened front elevational view thereof, the rear elevational view being a mirror image thereof;

FIG. 4 is a top plan view thereof; and,

FIG. 5 is a bottom plan view thereof.

(56) **References Cited**

U.S. PATENT DOCUMENTS

5,862,642	A *	1/1999	Erwin	52/834
6,061,991	A *	5/2000	Dahl	52/832
6,467,756	B1 *	10/2002	Elsasser	256/65.14
D497,211	S *	10/2004	Strassle	D25/126

1 Claim, 4 Drawing Sheets

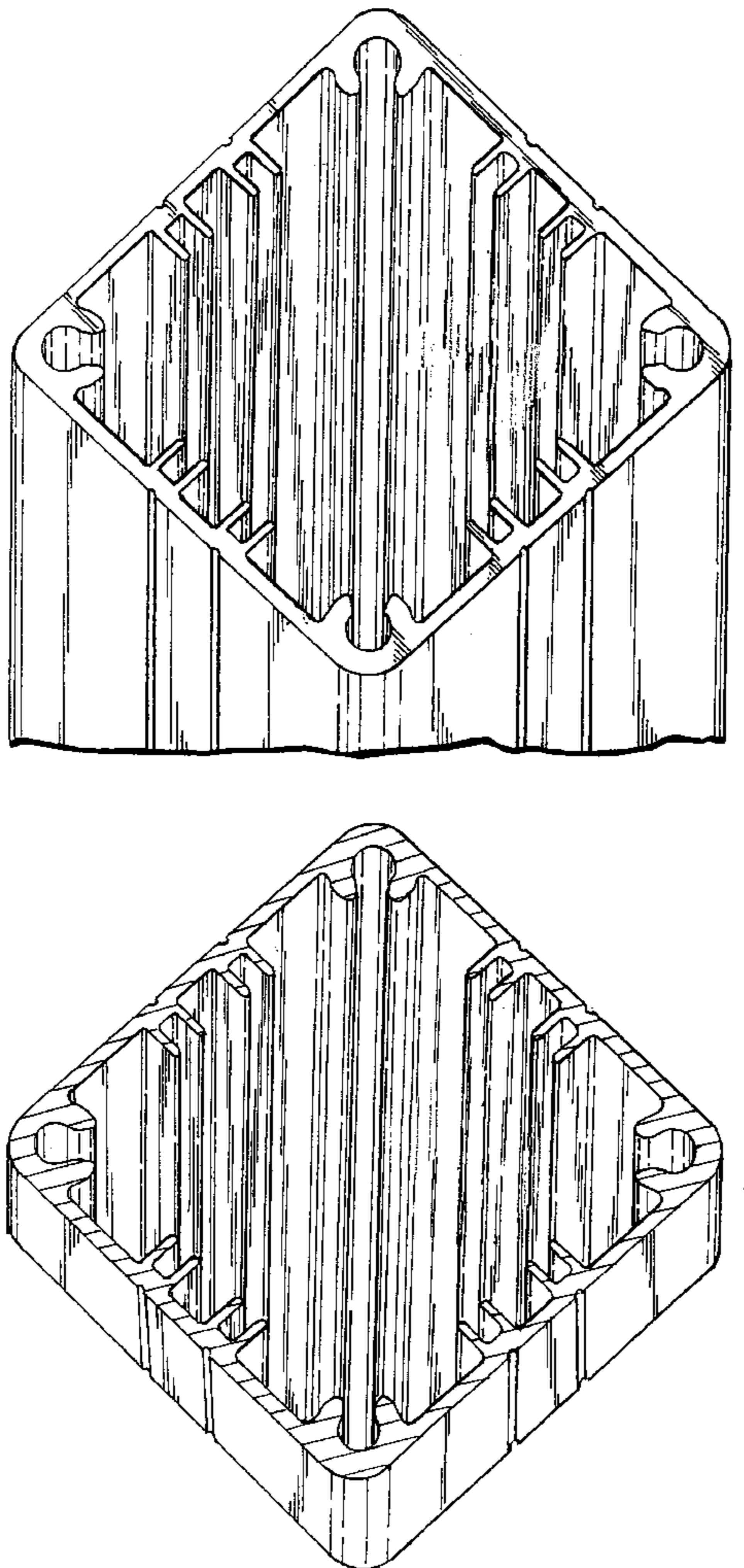

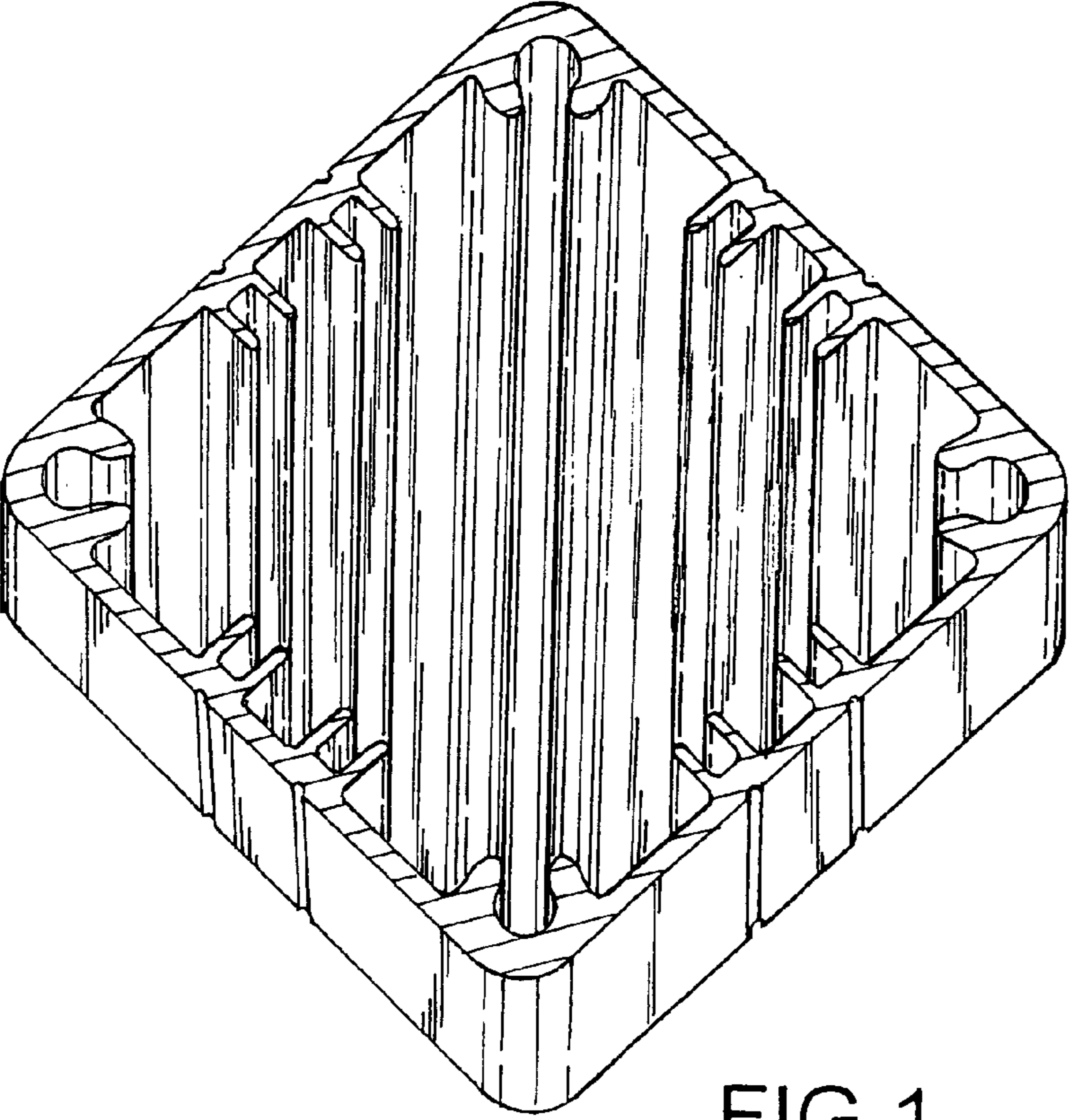
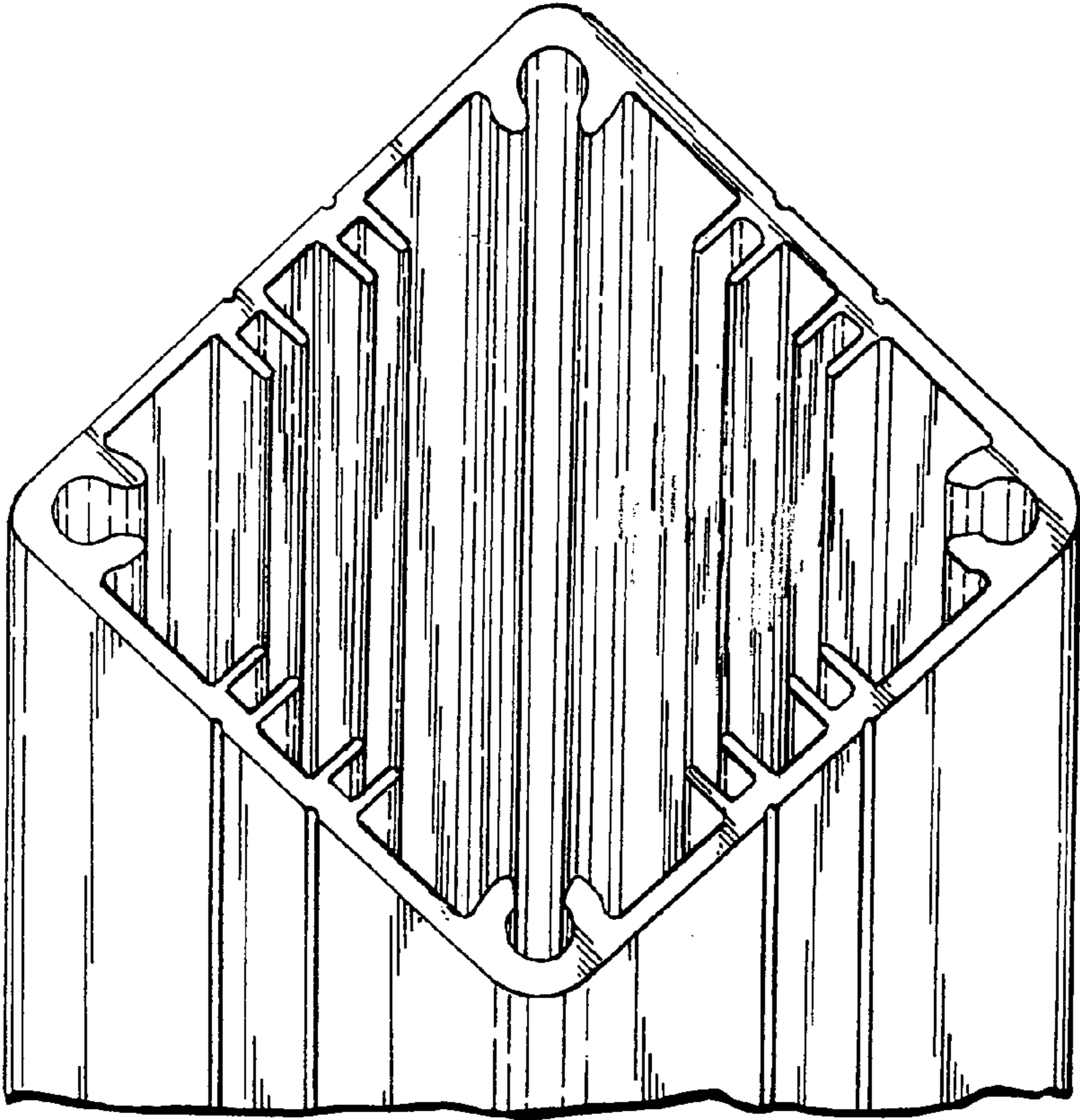

FIG. 1

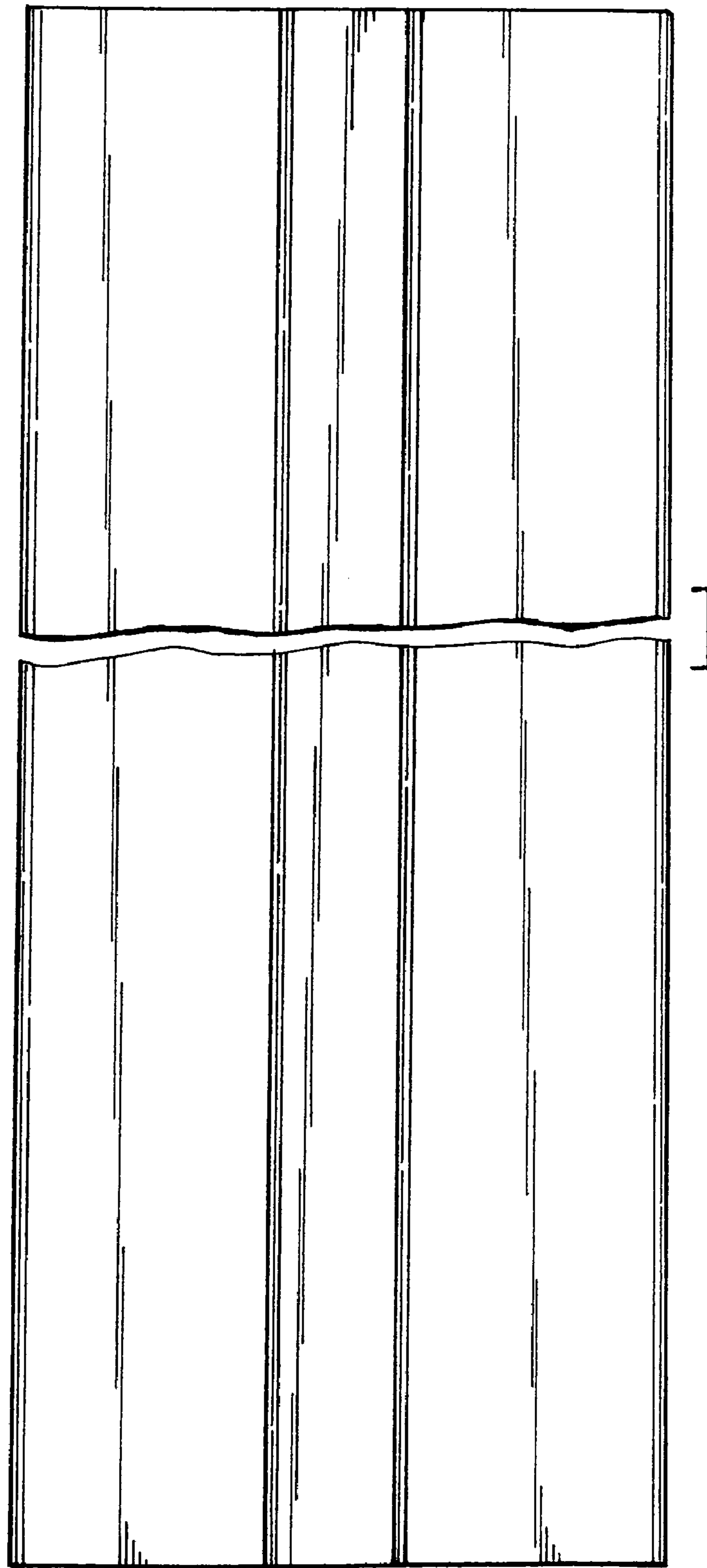

FIG.2

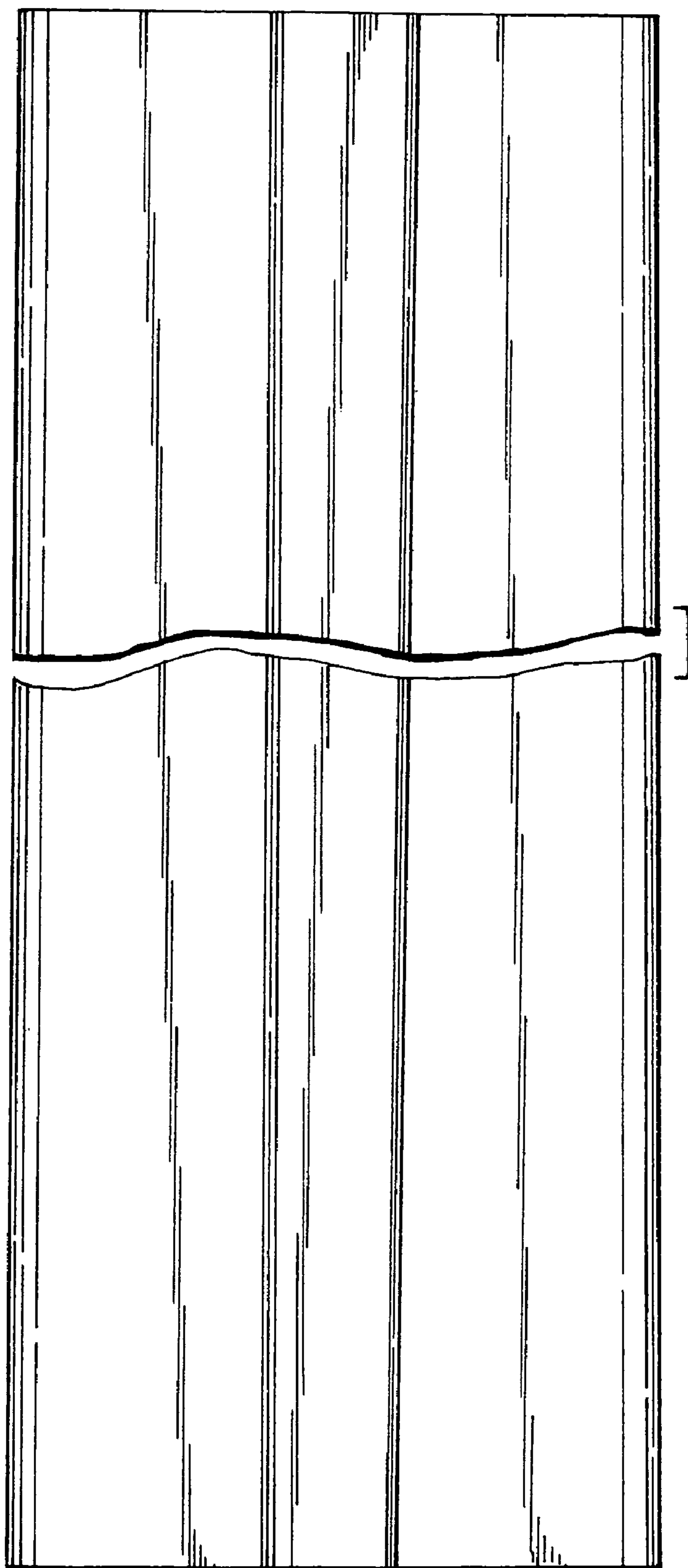

FIG.3

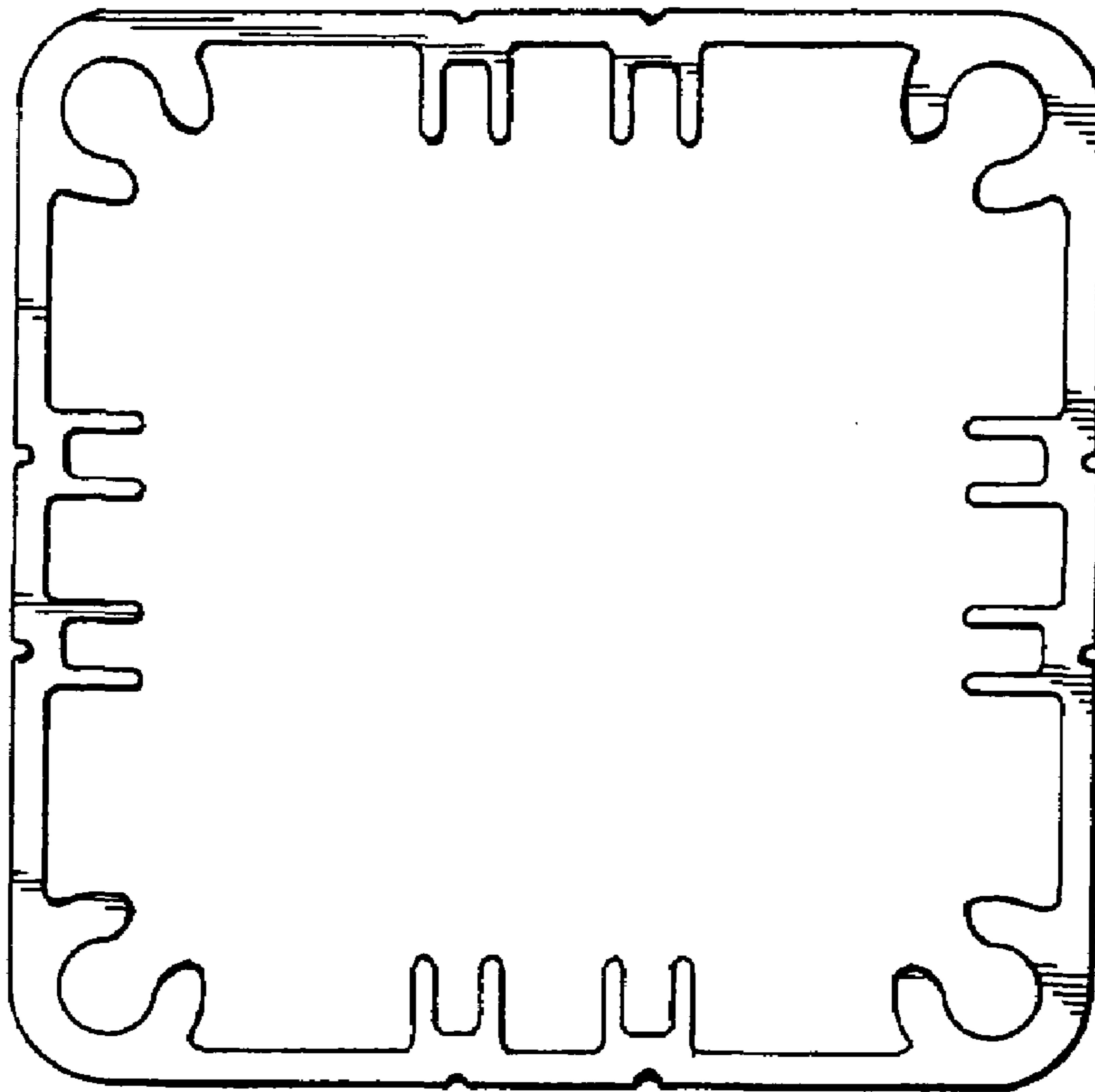

FIG. 4

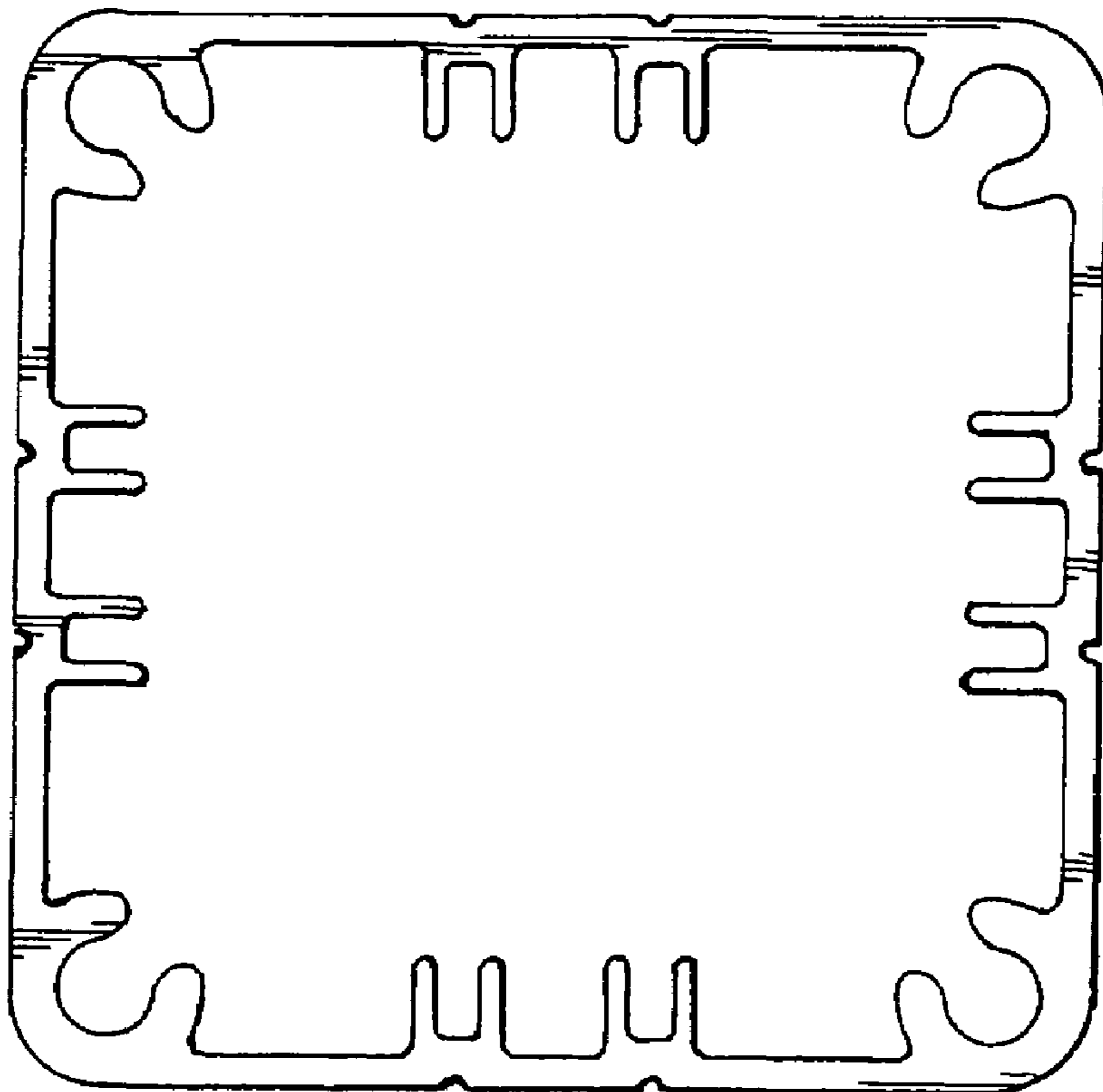

FIG. 5