



US00D616080S

(12) **United States Design Patent**
Ching

(10) **Patent No.:** **US D616,080 S**

(45) **Date of Patent:** **** May 18, 2010**

(54) **ELECTRIC HEATER**

D422,348 S * 4/2000 Liu D23/335

(75) Inventor: **Chan Ching**, Taipei Hsien (TW)

* cited by examiner

(73) Assignee: **Perfect Union Co., Ltd.**, Taipei Hsien (TW)

Primary Examiner—T. Chase Nelson
Assistant Examiner—Ania K Dworzecka

(74) *Attorney, Agent, or Firm*—Guice Patents PLLC

(**) Term: **14 Years**

(57) **CLAIM**

(21) Appl. No.: **29/335,525**

The ornamental design for an electric heater, as shown and described.

(22) Filed: **Apr. 16, 2009**

(51) **LOC (9) Cl.** **23-03**

(52) **U.S. Cl.** **D23/332**

(58) **Field of Classification Search** D23/317,
D23/314, 332, 333, 334, 335, 337, 342, 351,
D23/355, 378, 370, 381, 364, 336, 341; 416/244 R,
416/247 R, 53.1–53.3; 392/365, 367
See application file for complete search history.

DESCRIPTION

FIG. 1 is a top front and left side perspective view of electric heater showing my new design;

FIG. 2 is a front elevational view thereof;

FIG. 3 is a rear elevational view thereof;

FIG. 4 is a left side elevational view thereof;

FIG. 5 is a right side elevational view thereof;

FIG. 6 is a top plan view thereof; and,

FIG. 7 is a bottom plan view thereof.

The broken lines depict portions of the electric heater that form no part of the claimed design.

(56) **References Cited**

U.S. PATENT DOCUMENTS

D248,043 S *	5/1978	Schade	D23/335
D296,467 S *	6/1988	Wen-Ying	D23/335
D316,296 S *	4/1991	Lee	D23/335
D361,828 S *	8/1995	Chen	D23/335
D402,741 S *	12/1998	Chen	D23/335

1 Claim, 4 Drawing Sheets

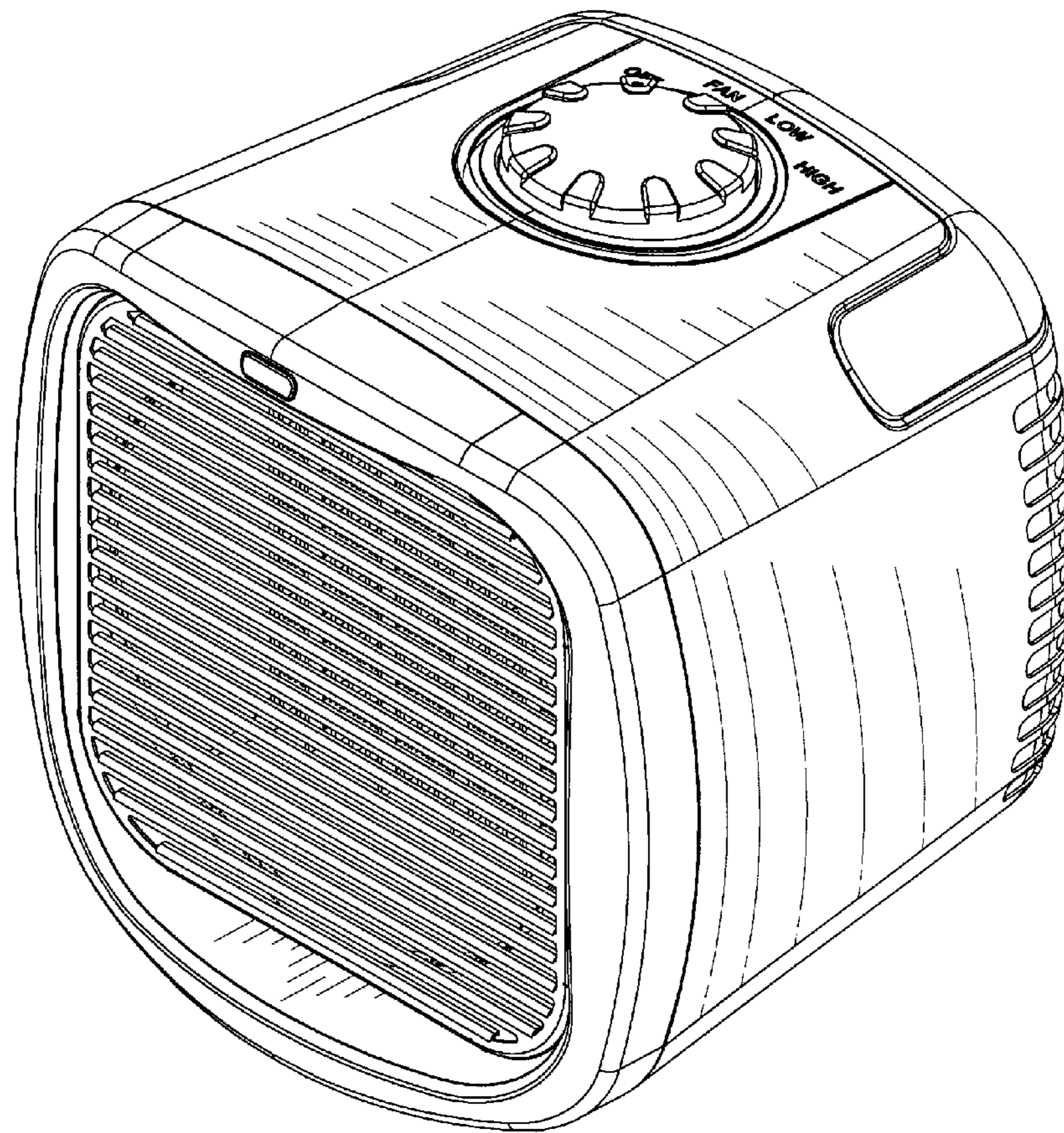

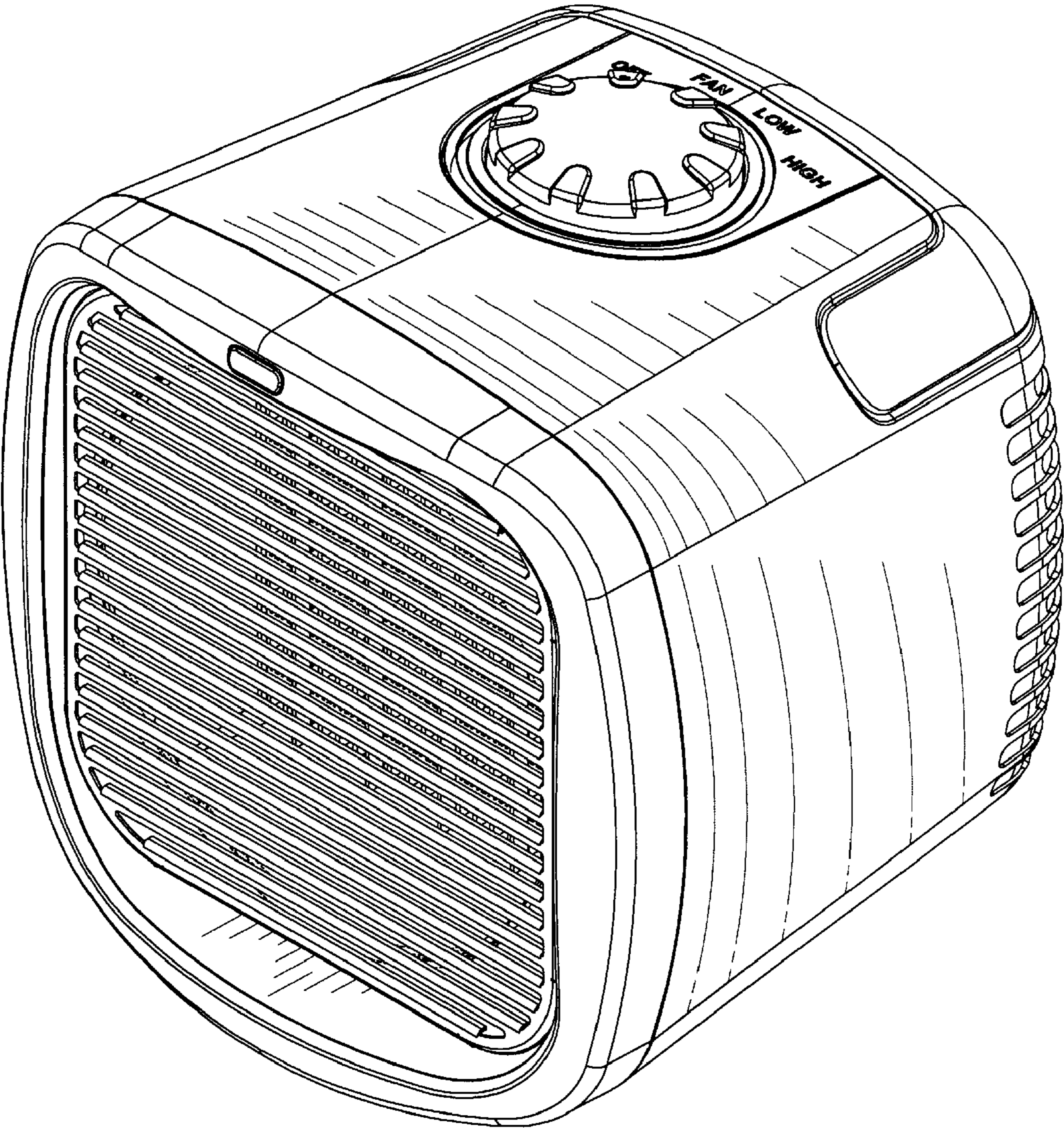

Fig. 1

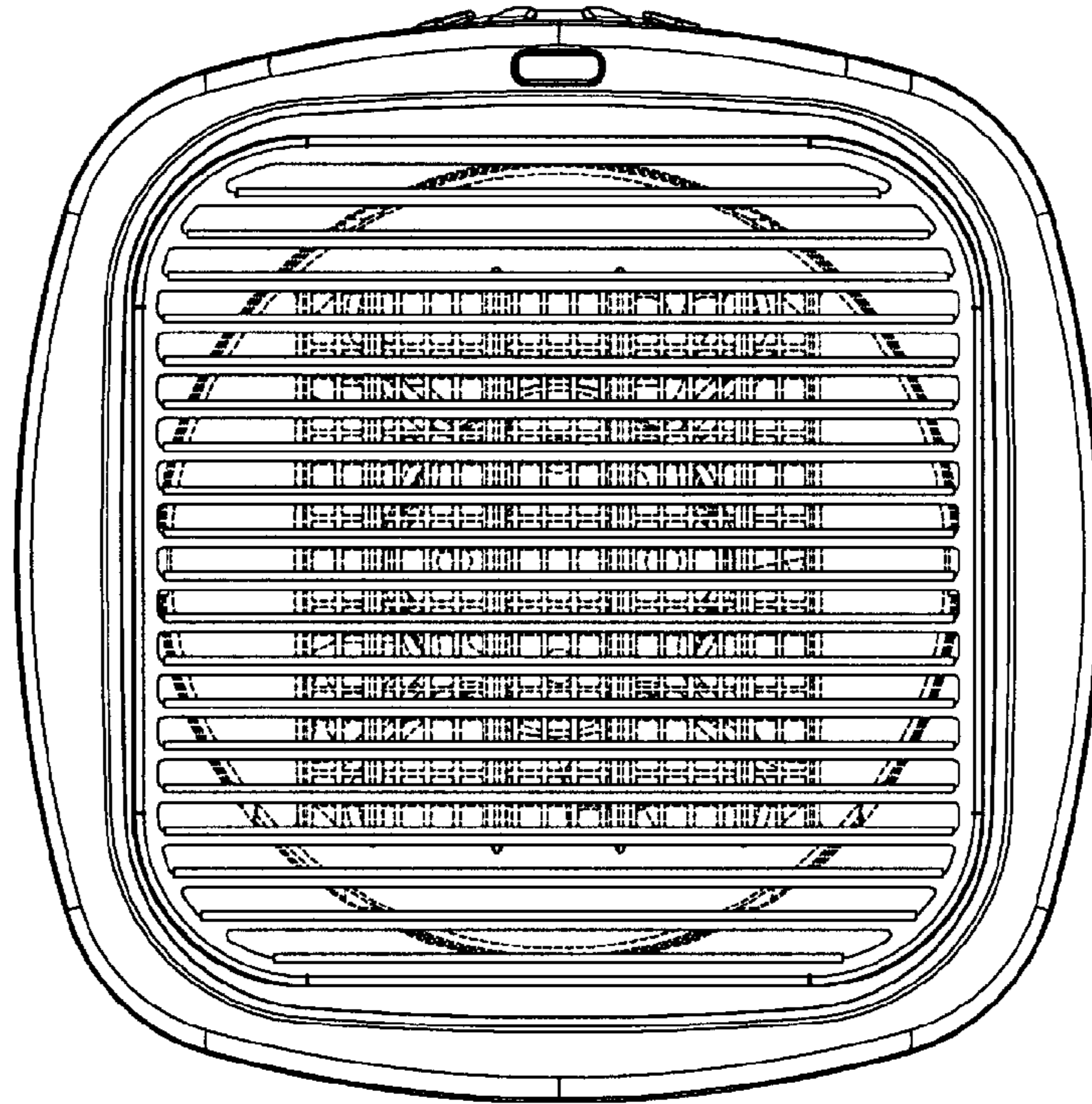

Fig.2

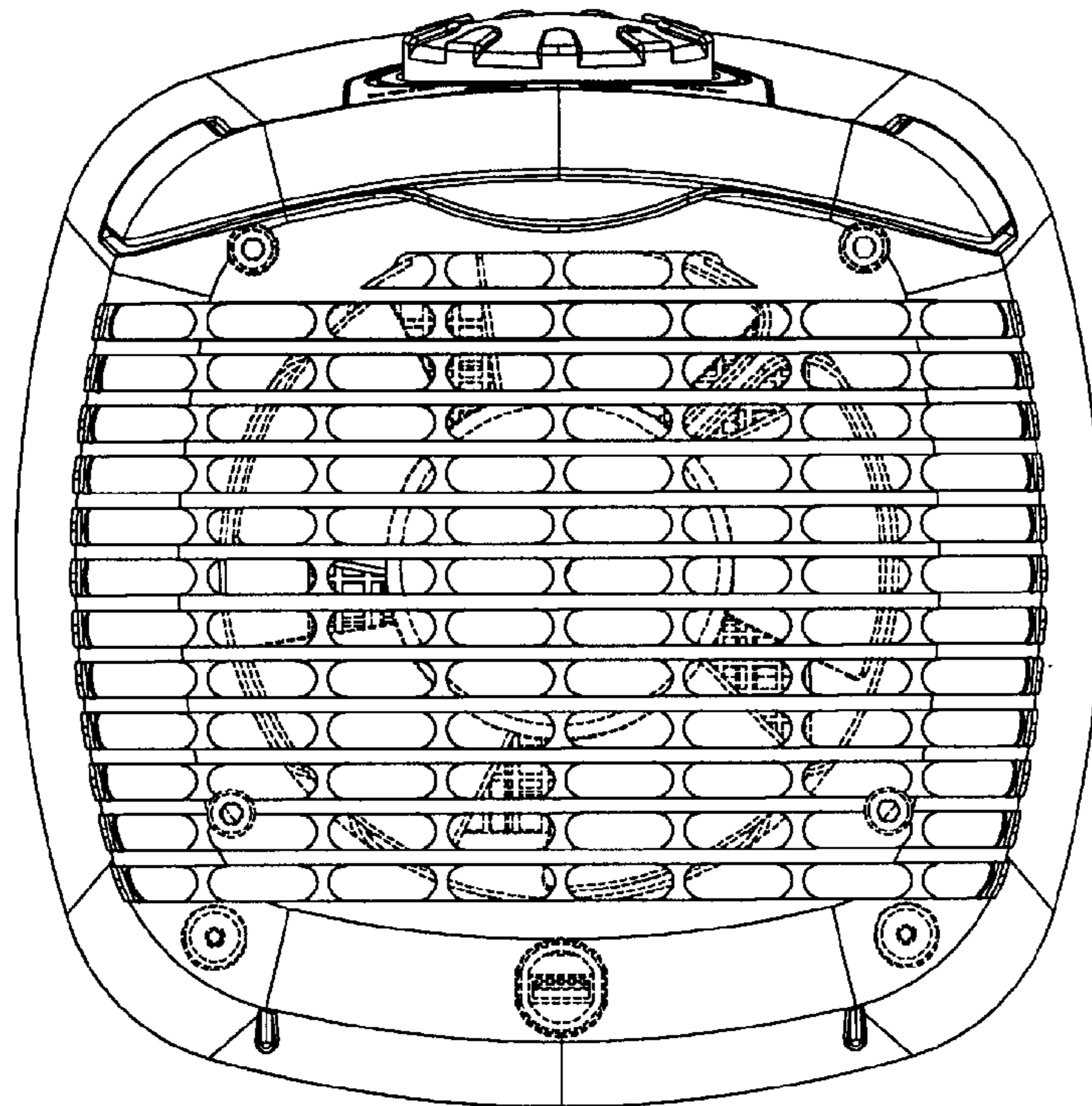

Fig.3

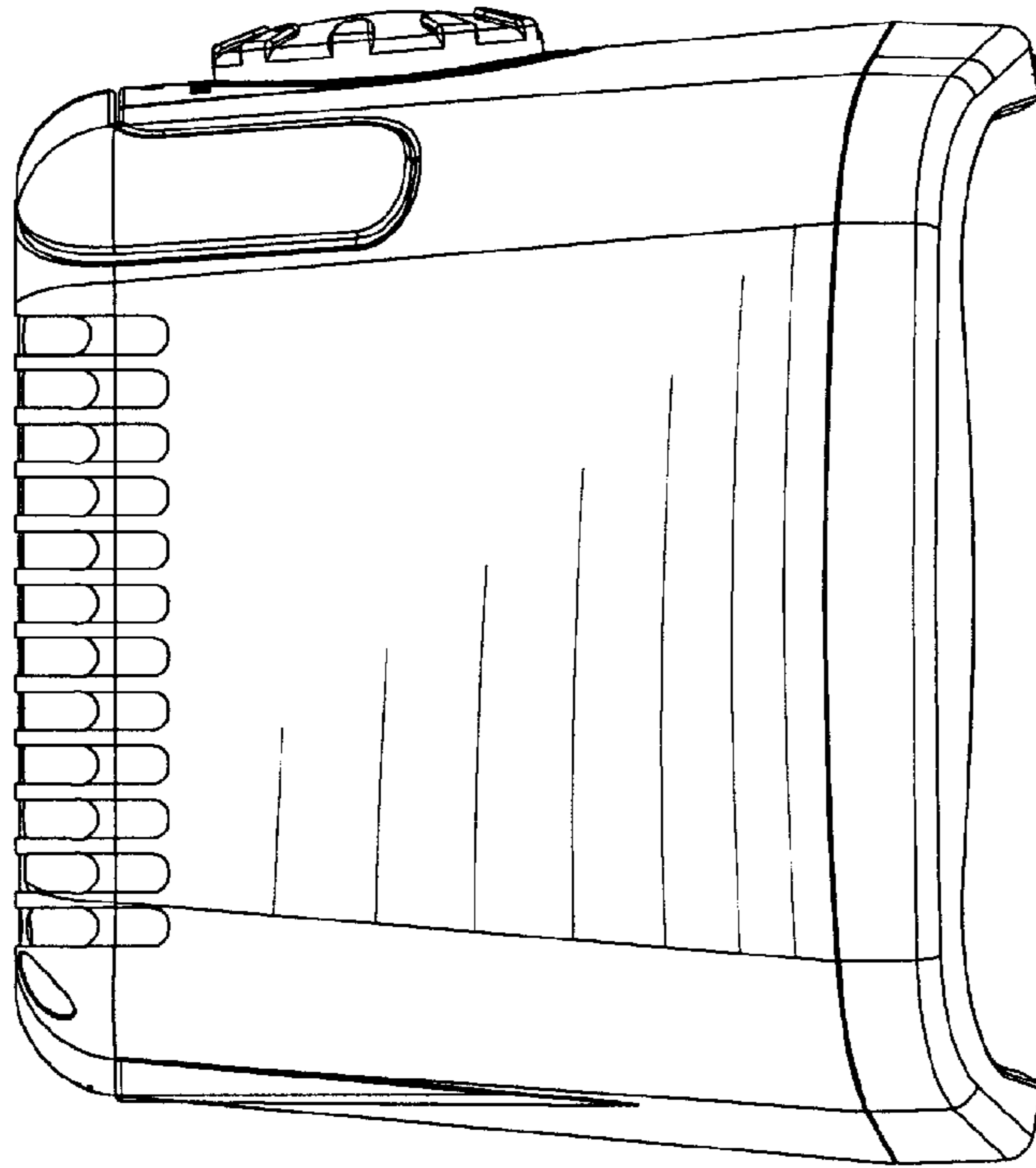

Fig.4

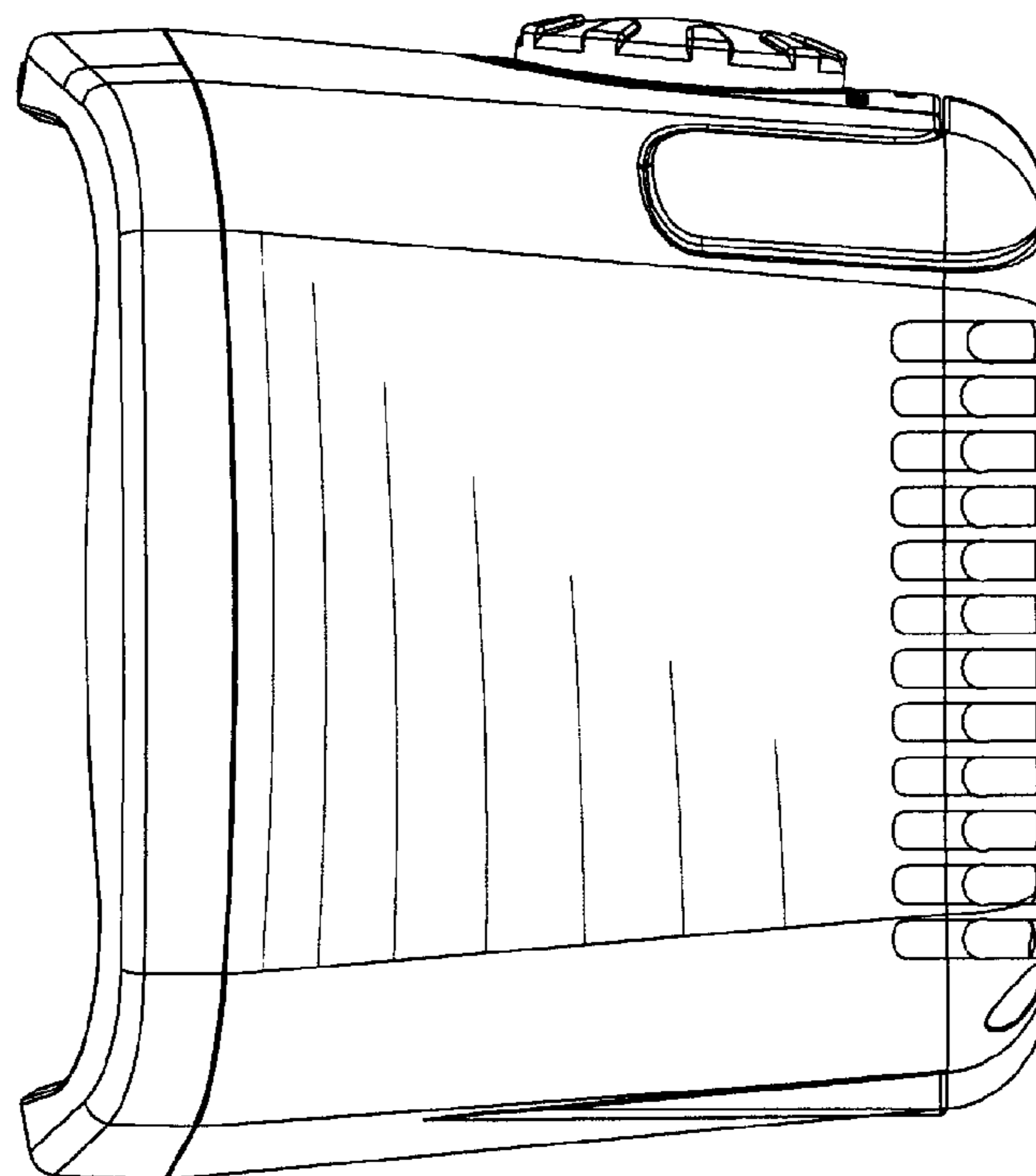

Fig.5

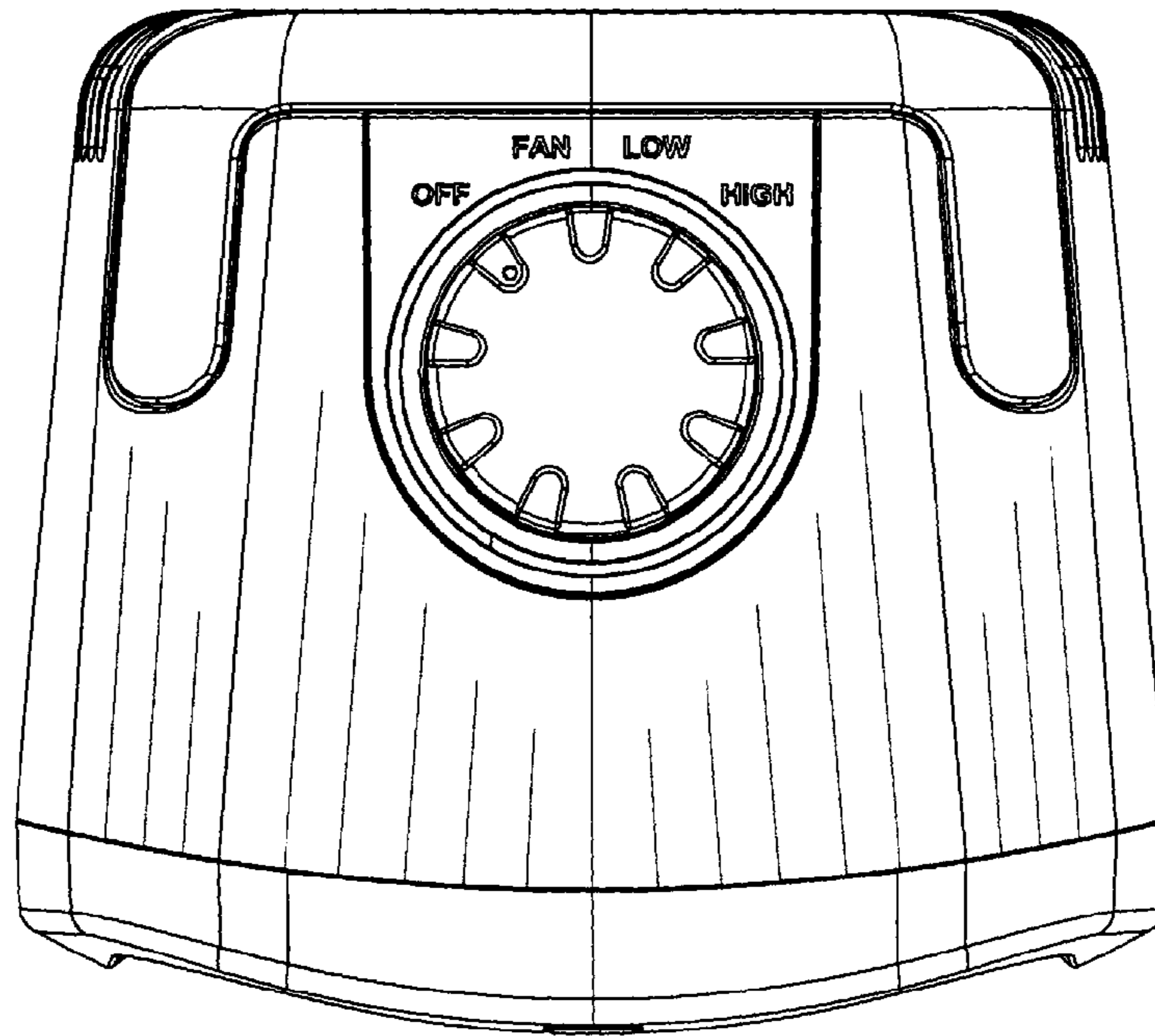

Fig.6

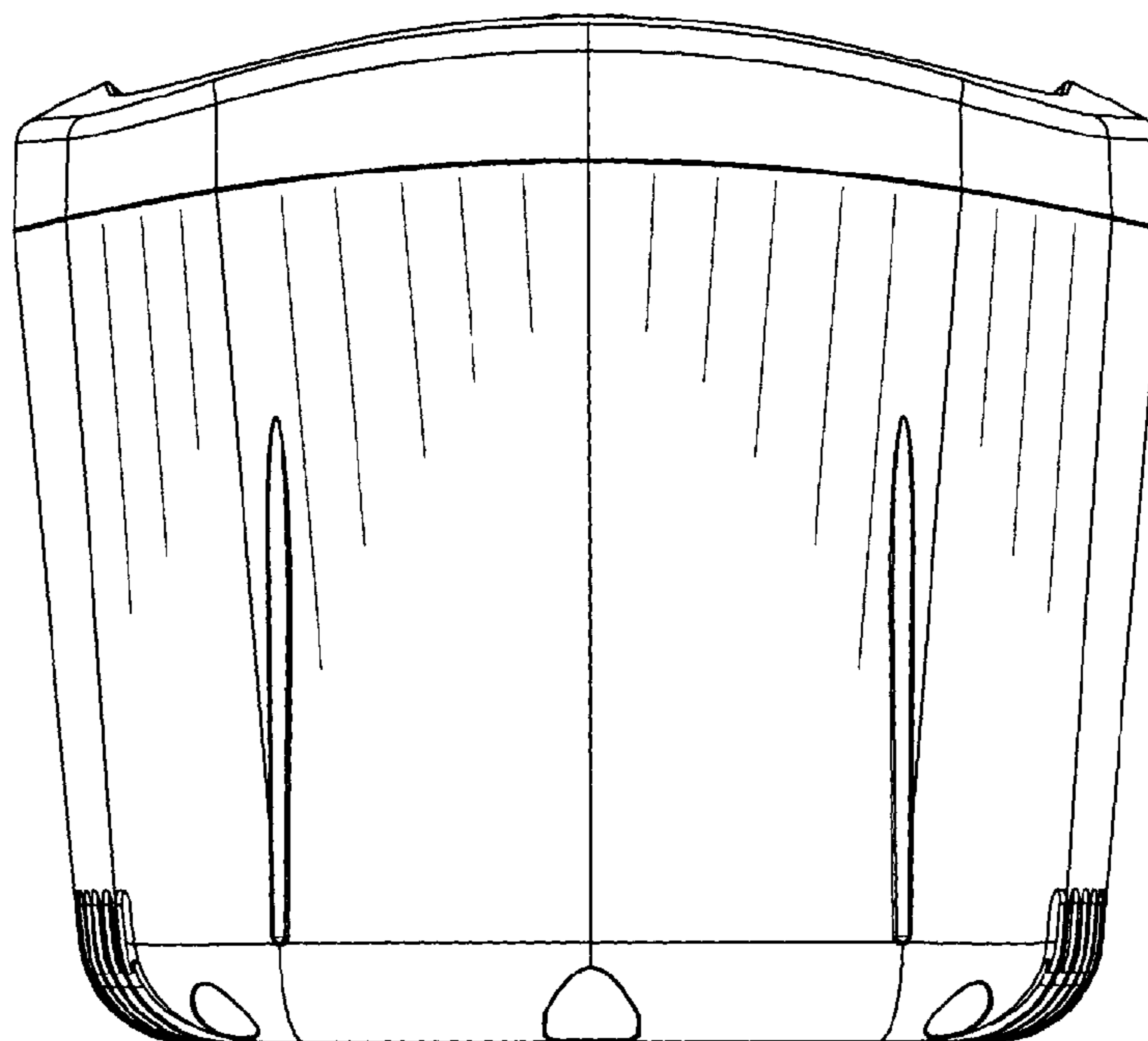

Fig.7