



US00D615942S

(12) **United States Design Patent**
Kim et al.

(10) **Patent No.:** **US D615,942 S**

(45) **Date of Patent:** **** May 18, 2010**

(54) **MOBILE PHONE**

7,372,413 B2 * 5/2008 Chang 343/702

(75) Inventors: **Eun-Young Kim**, Seoul (KR);
Young-Ju Yeo, Seoul (KR);
Chang-Hwan Hwang, Goyang-Si (KR)

D592,166 S * 5/2009 Song D14/138 AD

D593,987 S * 6/2009 Lin D14/138 AB

(73) Assignee: **Samsung Electronics Co., Ltd.**,
Suwon-Si (KR)

(Continued)

(**) Term: **14 Years**

OTHER PUBLICATIONS

(21) Appl. No.: **29/336,160**

Alcatel OT-E265, announced Feb. 2006, [online], [retrieved on Feb. 16, 2007]. Retrieved from Internet ,<URL: <http://www.gsmarena.com>>.*

(22) Filed: **Apr. 29, 2009**

(Continued)

(30) **Foreign Application Priority Data**

Jan. 16, 2009 (KR) 30-2009-0001922

Primary Examiner—Jeffrey D Asch

Assistant Examiner—Bridget L Eland

(51) **LOC (9) Cl.** **14-03**

(52) **U.S. Cl.** **D14/138 AD**

(58) **Field of Classification Search** D14/138 R,
D14/138 AD, 138 AC, 138 C, 138 G, 191,
D14/203.1–203.8, 496, 138 AA, 138 AB,
D14/247–248, 137, 147, 218, 341–347; D10/65,
D10/78, 104; D13/168; D18/7; 455/566,
455/575.1, 575.3

(74) *Attorney, Agent, or Firm*—Staas & Halsey LLP

(57) **CLAIM**

The ornamental design for mobile phone, as shown and described.

See application file for complete search history.

DESCRIPTION

(56) **References Cited**

U.S. PATENT DOCUMENTS

D337,569 S * 7/1993 Kando D14/341
D498,754 S * 11/2004 Blyth D14/341
D503,699 S * 4/2005 Lee et al. D14/138 AD
D509,202 S * 9/2005 Lee et al. D14/138 AD
D530,295 S * 10/2006 Chung et al. D14/138 AD
D534,515 S * 1/2007 Kim et al. D14/138 AD
7,181,256 B2 * 2/2007 Hyun et al. 455/575.3
D548,713 S * 8/2007 Lee et al. D14/138 AD
D553,601 S * 10/2007 Cho et al. D14/138 AD
D555,134 S * 11/2007 Sung et al. D14/138 AC
D556,169 S * 11/2007 Choi D14/138 AD
D557,238 S * 12/2007 Kim D14/138 AD
D565,598 S * 4/2008 Park D14/496
D565,599 S * 4/2008 Jang et al. D14/496

FIG. 1 is a front perspective view of a mobile phone;
FIG. 2 is a front view of the mobile phone of FIG. 1;
FIG. 3 is a rear view of the mobile phone of FIG. 1;
FIG. 4 is a left-side view of the mobile phone of FIG. 1;
FIG. 5 is a right-side view of the mobile phone of FIG. 1;
FIG. 6 is a top plan view of the mobile phone of FIG. 1;
FIG. 7 is a bottom plan view of the mobile phone of FIG. 1;
and,
FIG. 8 is a front slid up open view of the mobile phone of FIG. 1.

1 Claim, 6 Drawing Sheets

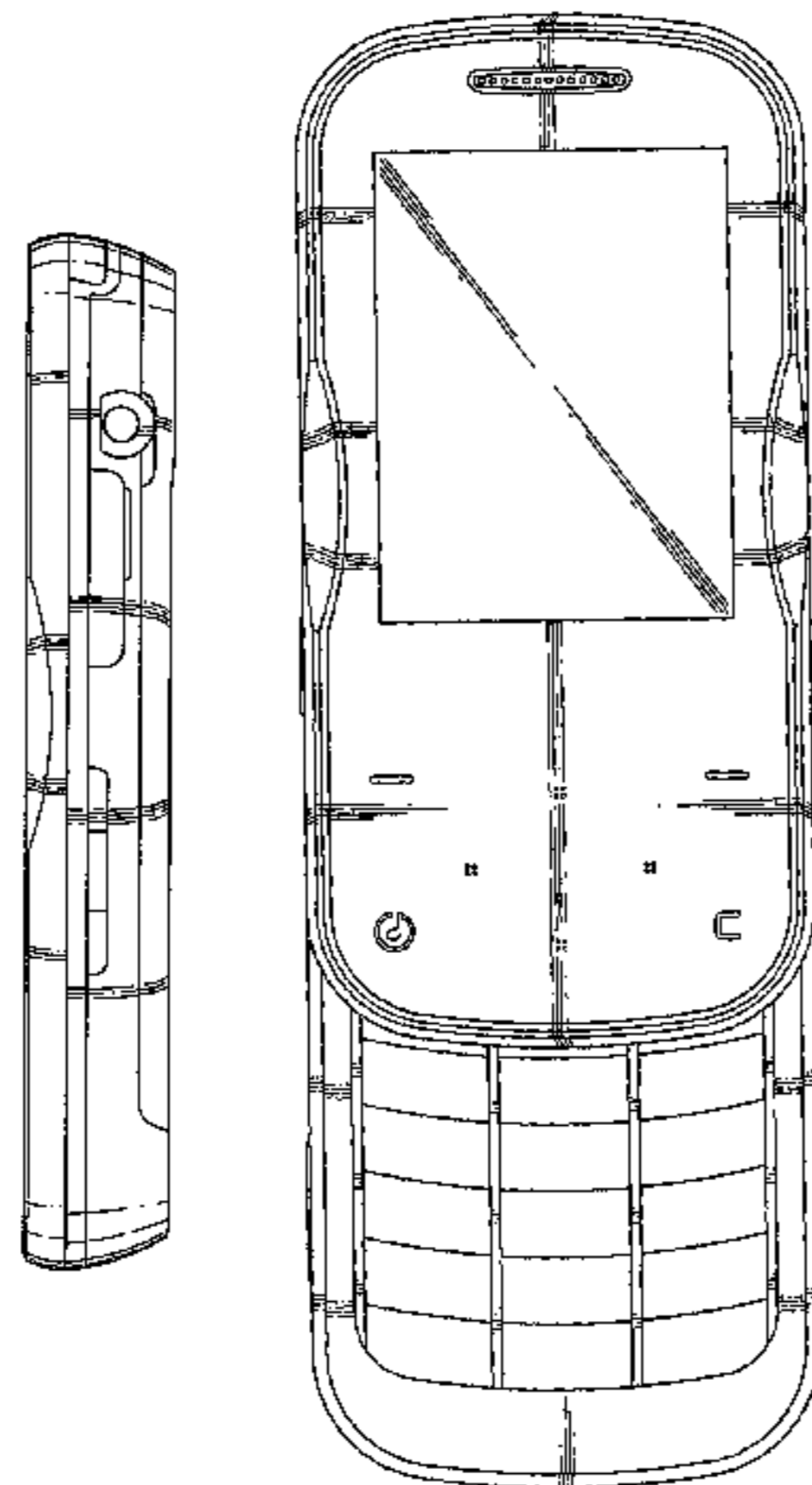

US D615,942 S

Page 2

U.S. PATENT DOCUMENTS

D593,993 S * 6/2009 Kim et al. D14/203.7
7,567,830 B2 * 7/2009 Hur 455/575.4
D601,538 S * 10/2009 Hong D14/138 G
D601,989 S * 10/2009 Park et al. D14/138 AD
D602,000 S * 10/2009 Oh et al. D14/203.7
D602,463 S * 10/2009 Eguchi D14/138 G
D605,155 S * 12/2009 Cha et al. D14/138 AD
2006/0093133 A1 * 5/2006 Park et al. 379/433.12

2008/0242377 A1* 10/2008 Lee 455/575.1

OTHER PUBLICATIONS

Alcatel OT-708 One Touch Mini, announced Jun. 2009, [online], [retrieved on Jun. 23, 2009 & Sep. 4, 2009]. Retrieved from Internet, <URL: <http://www.gsmarena.com>>.*

LG KF600, announced Feb. 2008, [online], [retrieved on Mar. 21, 2008]. Retrieved from Internet, <URL: <http://www.gsmarena.com>>.*

* cited by examiner

FIG. 1

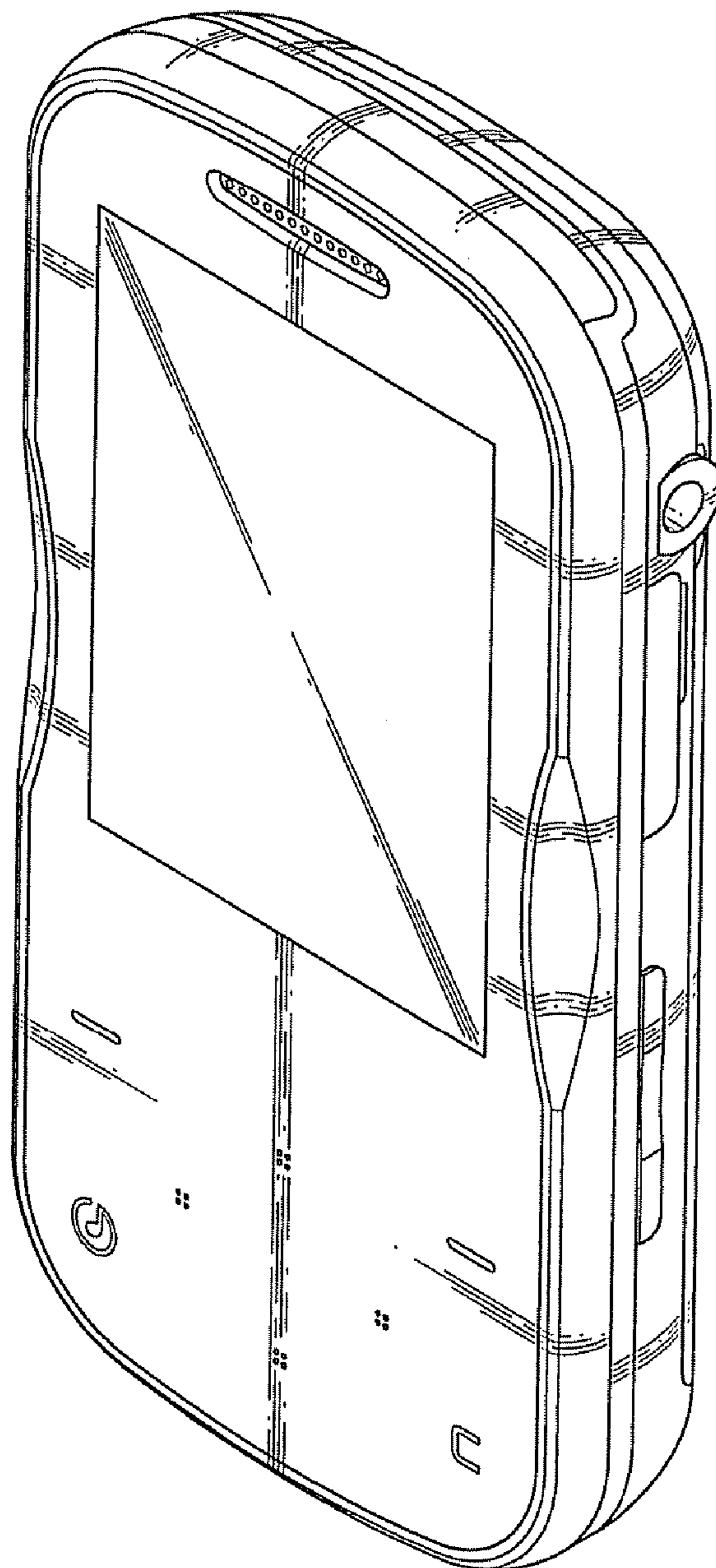

FIG. 2

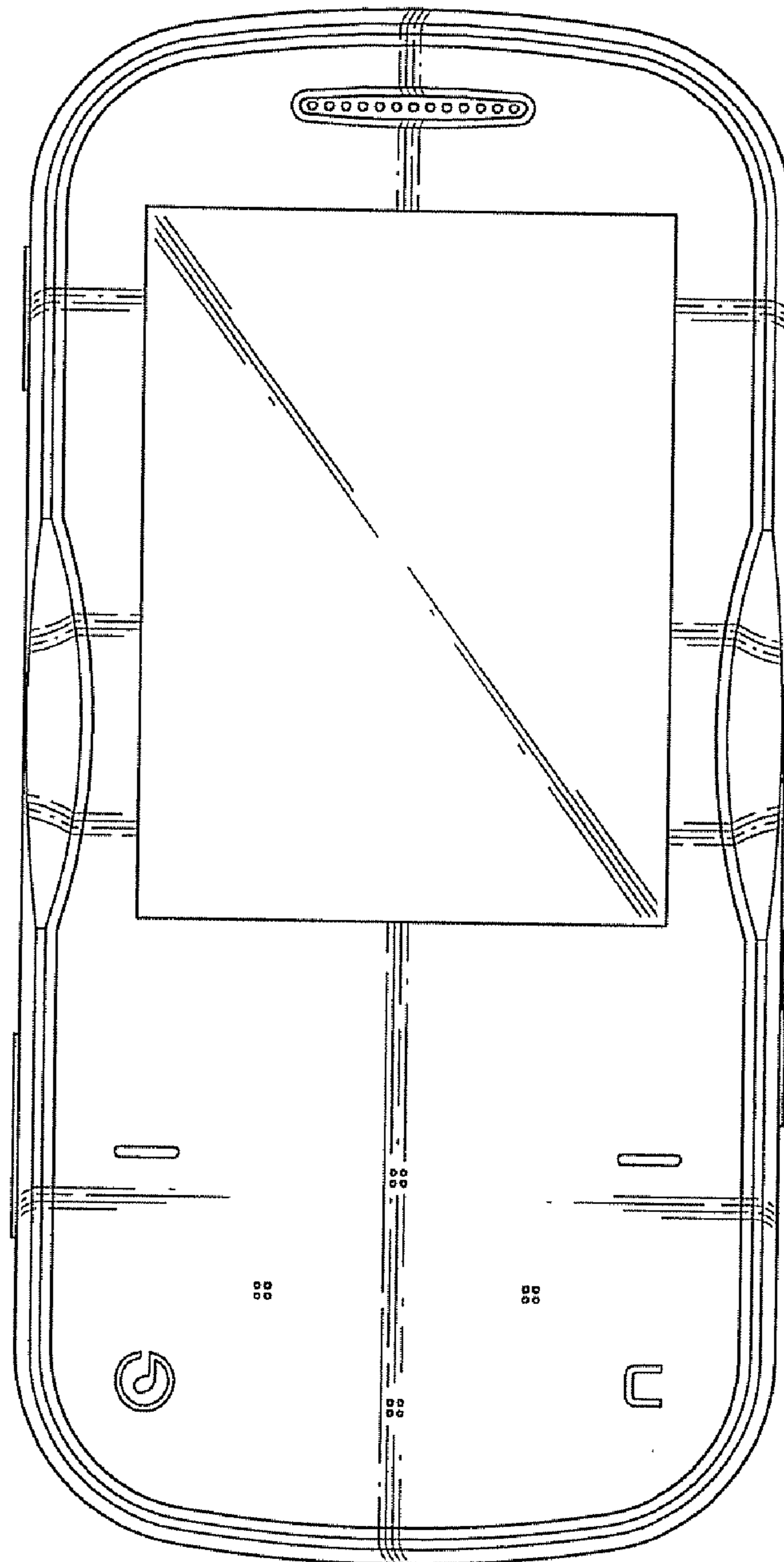

FIG. 3

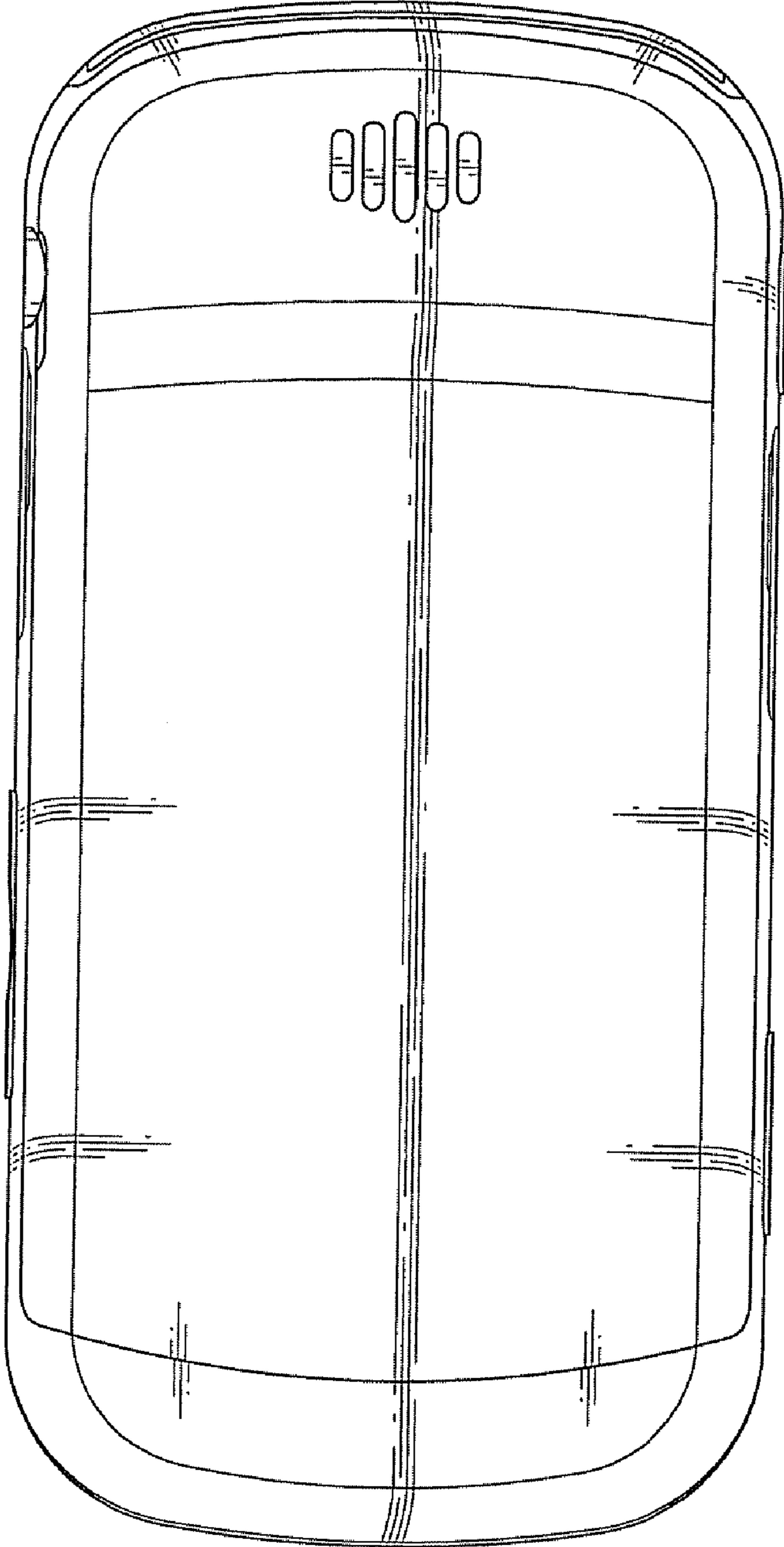

FIG. 4

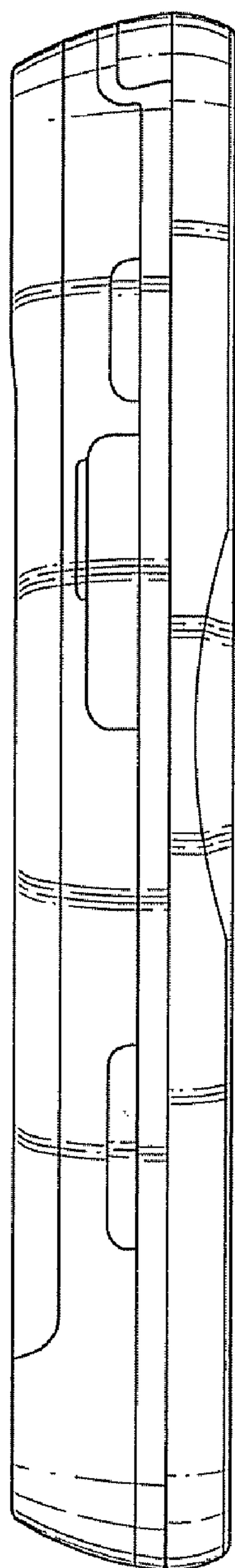

FIG. 5

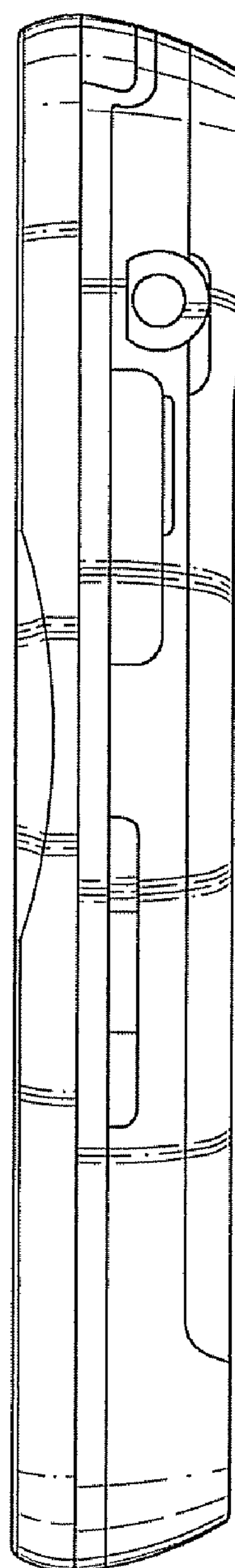

FIG. 6

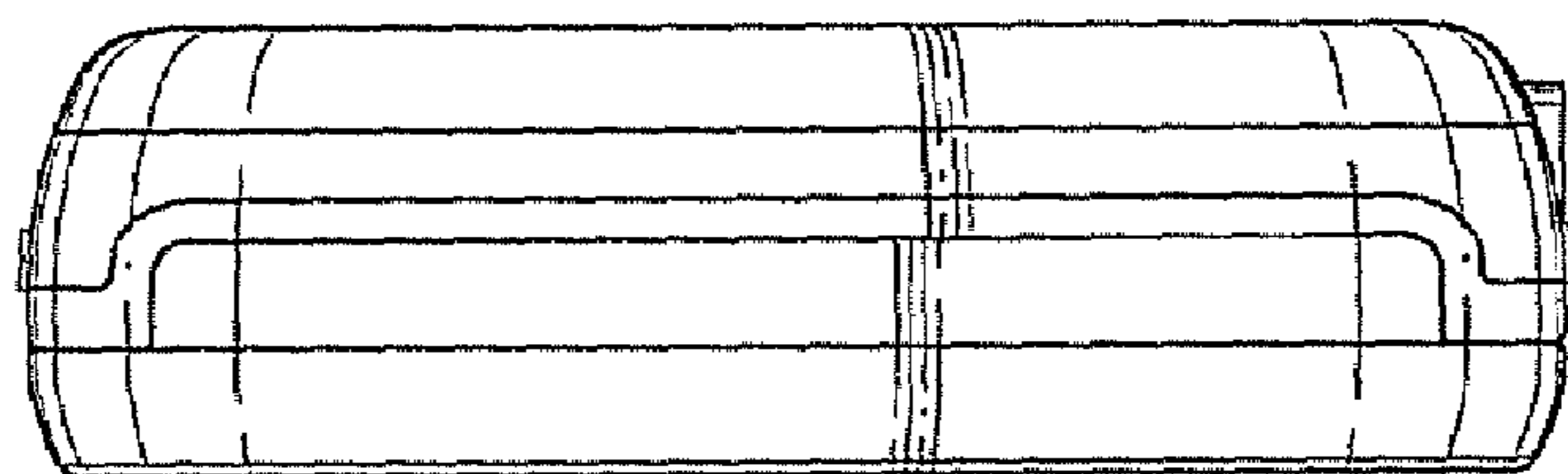

FIG. 7

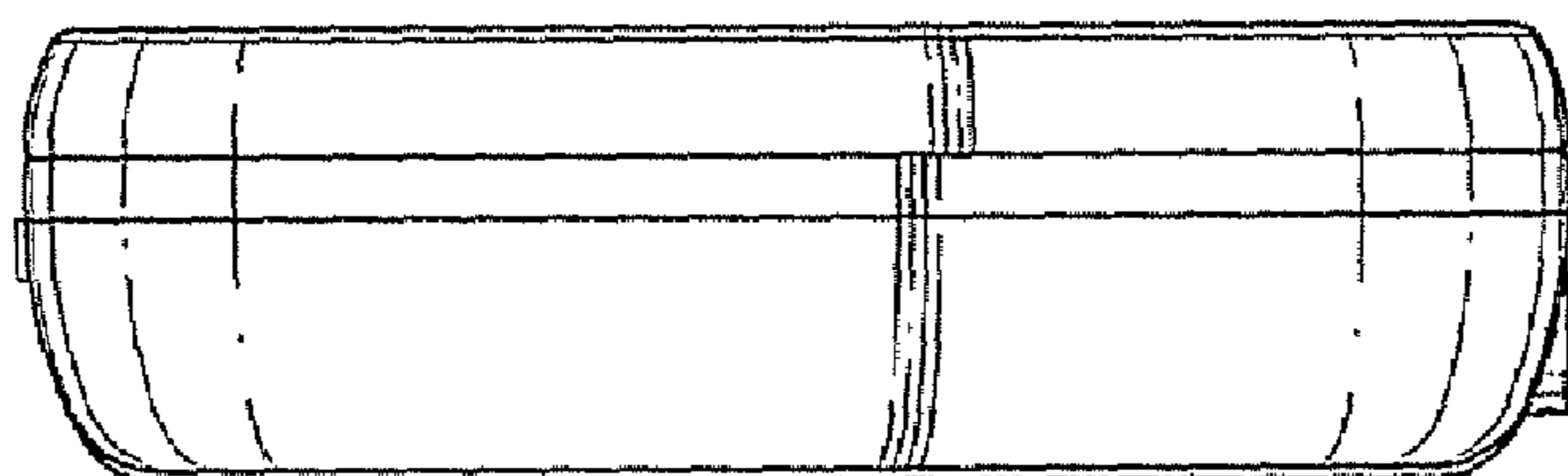

FIG. 8

