



US00D615913S

(12) **United States Design Patent**
Akasawa et al.

(10) **Patent No.:** **US D615,913 S**

(45) **Date of Patent:** **** May 18, 2010**

(54) **FRONT BUMPER FOR MOTOR VEHICLE**

(75) Inventors: **Kenichi Akasawa**, Chigasaki (JP);
Hiroshi Kusakawa, Chigasaki (JP)

(73) Assignee: **Autech Japan Inc.**, Kanagawa (JP)

(**) Term: **14 Years**

(21) Appl. No.: **29/350,664**

(22) Filed: **Nov. 20, 2009**

(51) **LOC (9) Cl.** **12-16**

(52) **U.S. Cl.** **D12/169**

(58) **Field of Classification Search** D12/169,
D12/196, 171, 163, 216, 90-92, 86; 293/102,
293/113, 115, 117, 120; 296/180.1, 180.2
See application file for complete search history.

(56) **References Cited**

U.S. PATENT DOCUMENTS

D561,072 S *	2/2008	Golden et al.	D12/169
D563,290 S *	3/2008	Morishita et al.	D12/169
D565,482 S *	4/2008	Abe	D12/169
D566,016 S *	4/2008	Pfeiffer	D12/169
D579,388 S *	10/2008	Akasawa et al.	D12/169

D586,709 S *	2/2009	Saridakis et al.	D12/169
D606,912 S *	12/2009	Sahs	D12/169
D609,143 S *	2/2010	Kruger et al.	D12/169

* cited by examiner

Primary Examiner—Melody N Brown

(74) *Attorney, Agent, or Firm*—Wenderoth, Lind & Ponack,
L.L.P.

(57) **CLAIM**

An ornamental design for the front bumper for the motor vehicle, as shown and described.

DESCRIPTION

FIG. 1 is a front view of the front bumper for the motor vehicle showing our new design;

FIG. 2 is a top plan view thereof;

FIG. 3 is a bottom view thereof;

FIG. 4 is a rear view showing thereof;

FIG. 5 is a right side view thereof;

FIG. 6 is a left side view thereof; and,

FIG. 7 is a perspective view thereof.

1 Claim, 4 Drawing Sheets

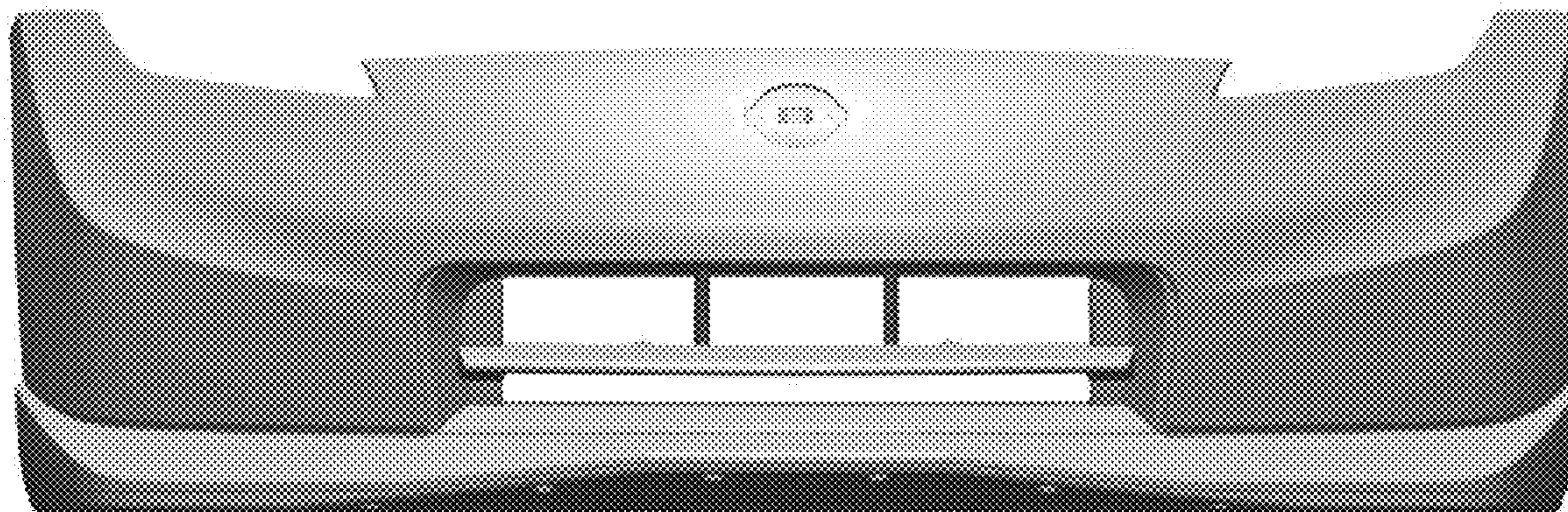

FIG. 1

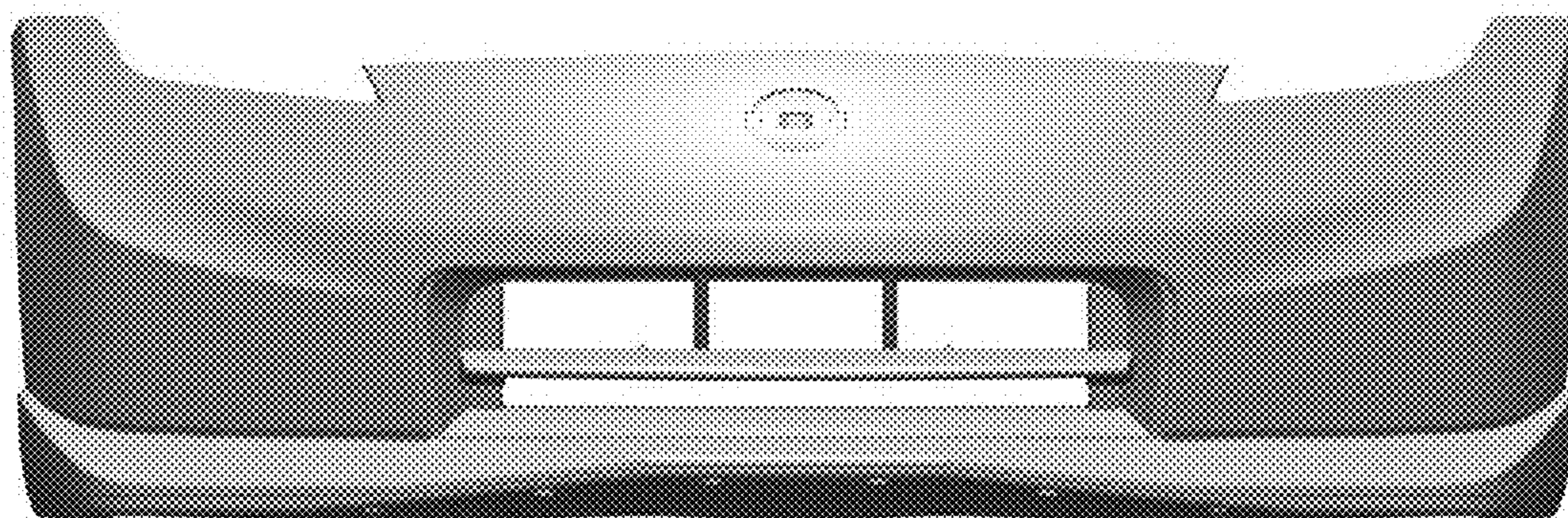

FIG. 2

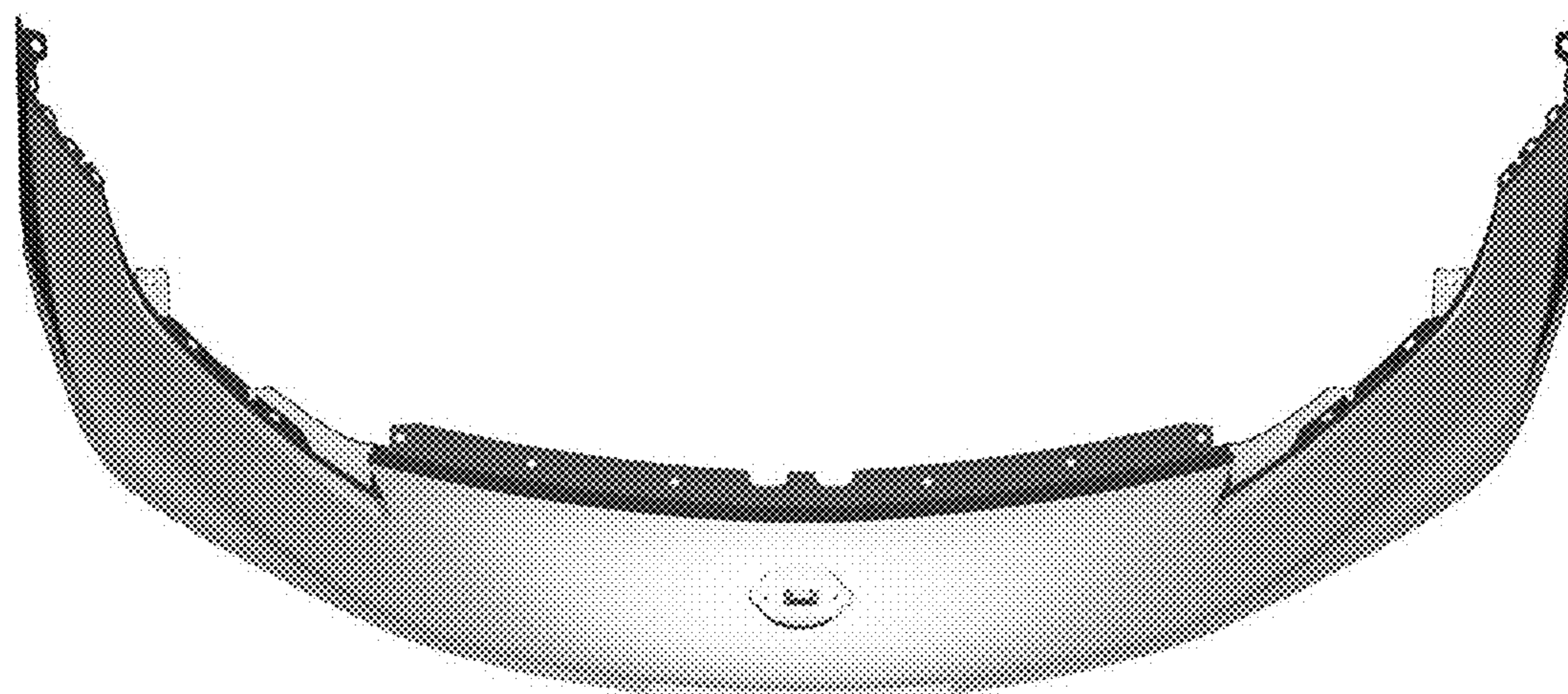

FIG. 3

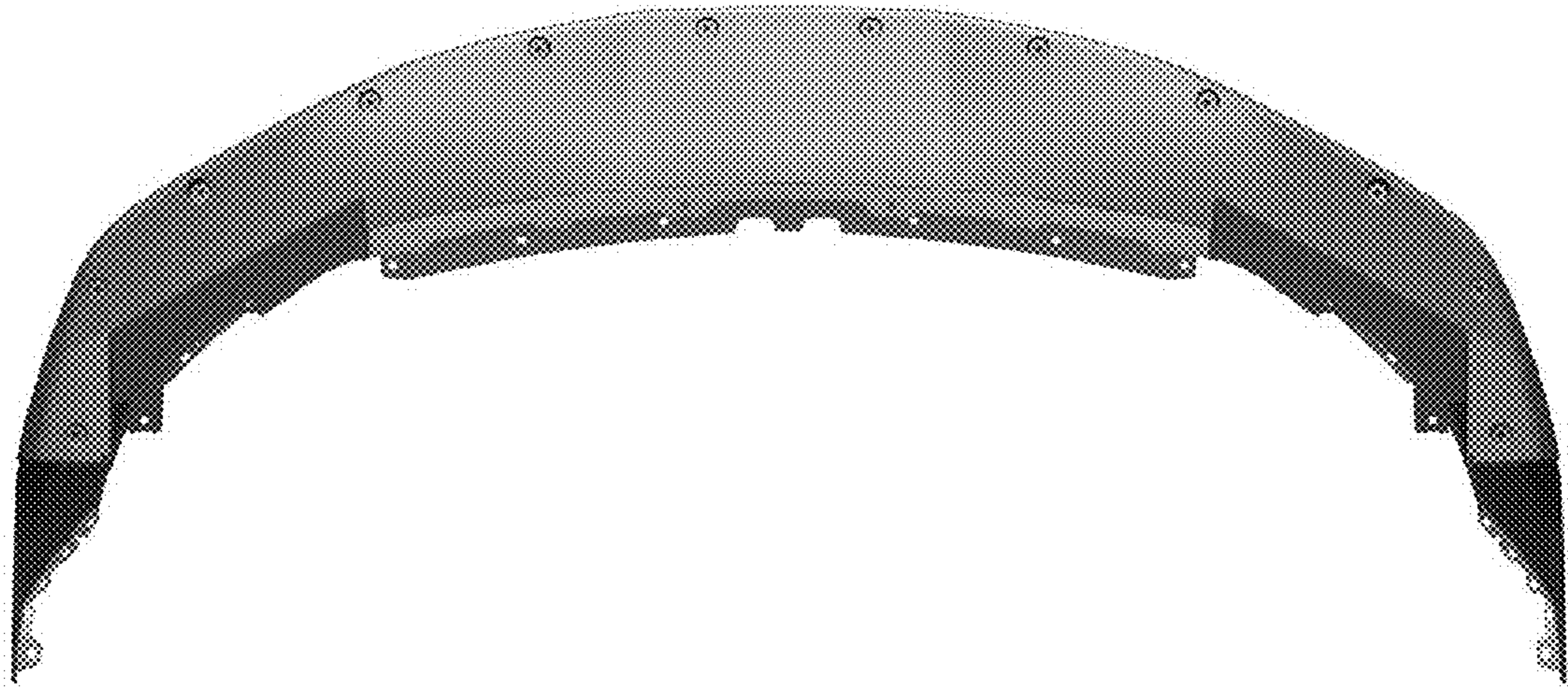

FIG. 4

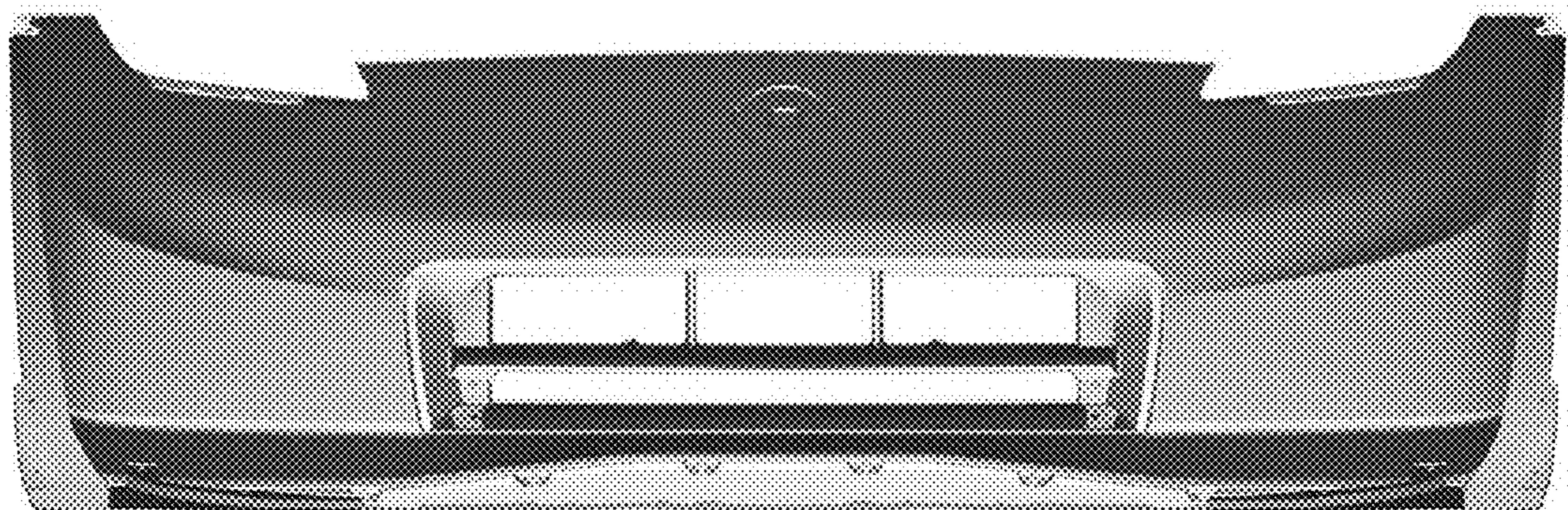

FIG. 5

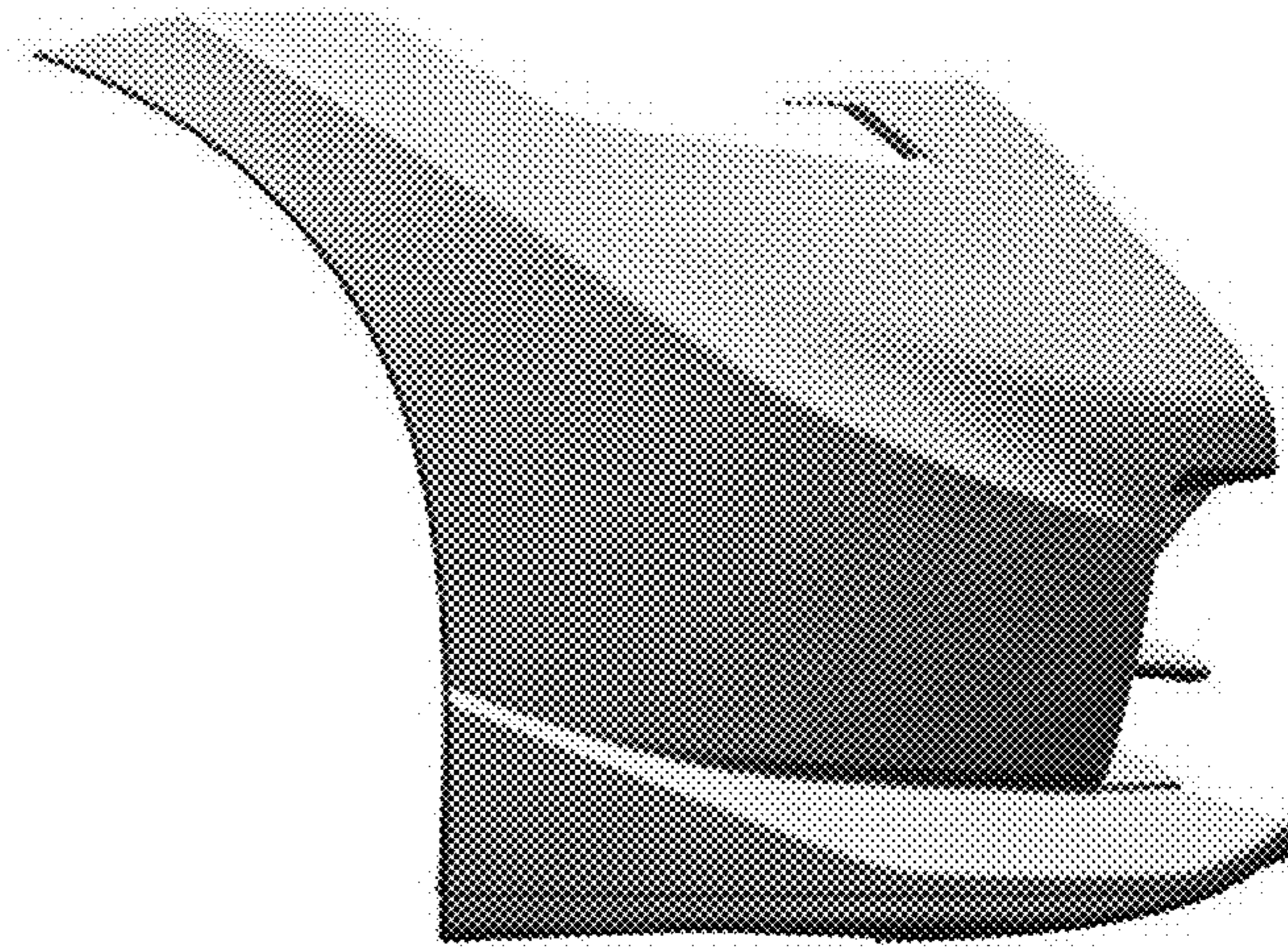

FIG. 6

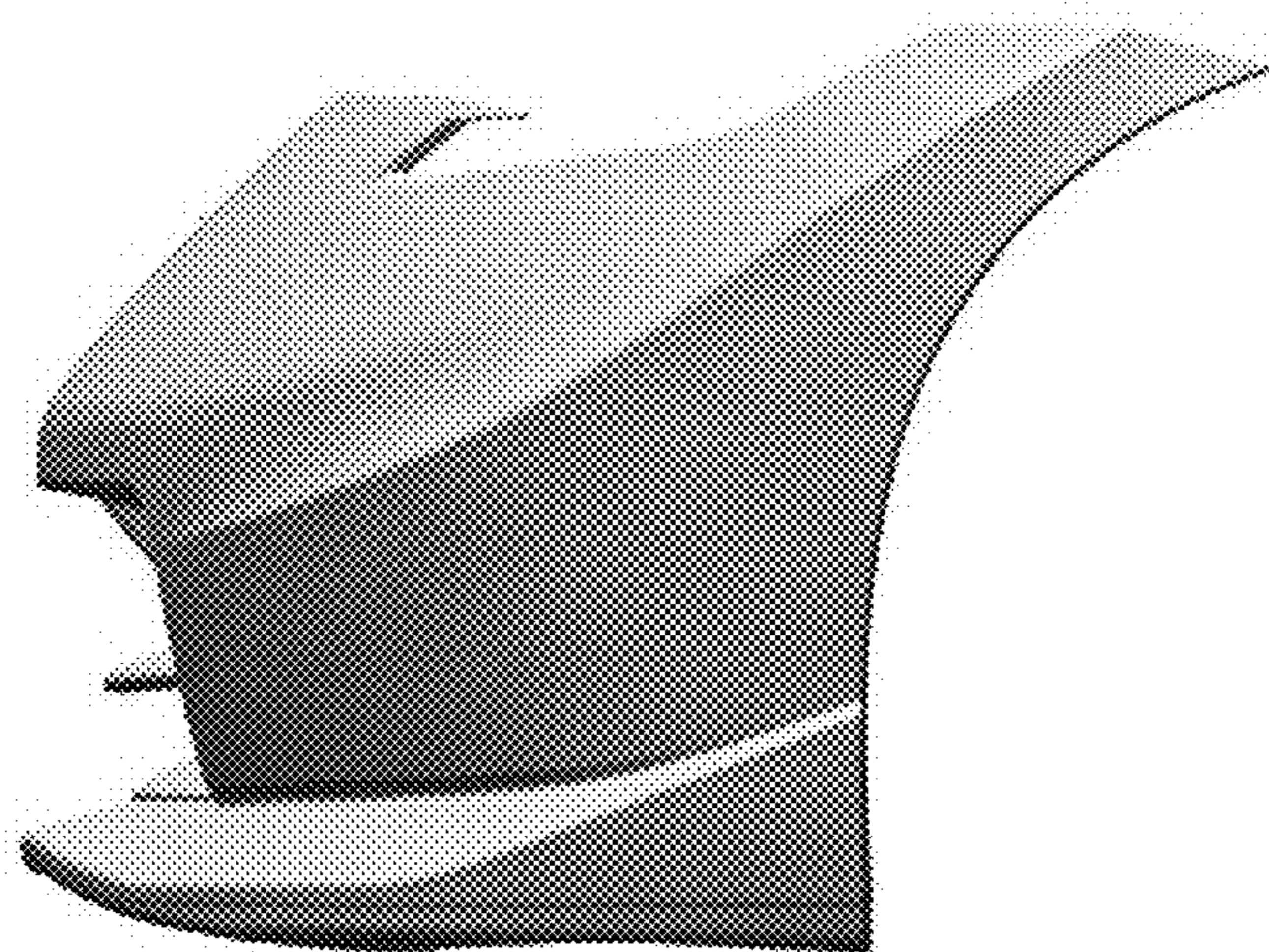

FIG. 7

