



US00D615841S

(12) **United States Design Patent**
Donaldson et al.

(10) **Patent No.:** **US D615,841 S**
(45) **Date of Patent:** **** May 18, 2010**

(54) **BLAST LOCK HANDLE WITH ANGLED BODY**

(75) Inventors: **Robert W. Donaldson**, Eureka, MO (US); **Brandon L. Hemann**, New Hampton, IA (US)

(73) Assignee: **Trimark Corporation**, New Hampton, IA (US)

(**) Term: **14 Years**

(21) Appl. No.: **29/333,728**

(22) Filed: **Mar. 13, 2009**

(51) **LOC (9) Cl.** **08-06**

(52) **U.S. Cl.** **D8/308**

(58) **Field of Classification Search** D8/300,
D8/308, 17, 22, 23, 28, 80, 81, 88, 89, 107,
D8/337, 338; D23/250, 252; 292/336.3;
29/270, 278; 81/90.6, 124.3, 125.1, 121.1,
81/124.7, 128, 129, 488; D7/396; 16/110.1
See application file for complete search history.

(56) **References Cited**

U.S. PATENT DOCUMENTS

64,662 A *	5/1867	Gold	7/138
488,510 A *	12/1892	Unbehend	81/487
805,072 A *	11/1905	Deuring	29/270
D73,604 S *	10/1927	Kraus	D21/486
D105,338 S *	7/1937	McNaught	D8/17
2,332,602 A *	10/1943	Rosenbloom	81/125.1
2,391,394 A *	12/1945	Cogbill	81/124.3
D215,814 S *	11/1969	Kraus	D8/308
D222,427 S *	10/1971	Deuring	D8/308
4,108,026 A *	8/1978	Anderson et al.	81/488
D264,796 S *	6/1982	Frick et al.	D8/17
4,463,631 A *	8/1984	Barnes et al.	81/3.09

4,641,865 A	2/1987	Pastva	
4,714,282 A	12/1987	Henderson	
D329,186 S *	9/1992	Sorensen	D8/307
D333,254 S *	2/1993	Ringle'	D8/308
5,197,176 A *	3/1993	Reese	29/278
5,663,520 A	9/1997	Ladika et al.	
D389,710 S *	1/1998	Baber	D8/28
6,098,503 A *	8/2000	Hlinka	81/124.3
D444,855 S *	7/2001	Green et al.	D23/252
6,363,830 B1	4/2002	Gonzalez	
7,097,216 B2	8/2006	Lane et al.	
7,111,879 B2	9/2006	Zweibohmer et al.	
7,198,308 B2	4/2007	Lane et al.	
D596,917 S *	7/2009	Donaldson et al.	D8/308

* cited by examiner

Primary Examiner—Paula Greene

(74) *Attorney, Agent, or Firm*—McKee, Voorhees & Sease, P.L.C.

(57) **CLAIM**

We claim the ornamental design for a blast lock handle with angled body, substantially as shown and described.

DESCRIPTION

FIG. 1 is a front elevational view of a blast lock handle with angled body showing our new design;

FIG. 2 is a front elevational view thereof;

FIG. 3 is a side elevation view thereof;

FIG. 4 is an opposite side elevational view thereof;

FIG. 5 is an end elevational view thereof;

FIG. 6 is an opposite end elevational view thereof; and,

FIG. 7 is a perspective view thereof.

The broken lines form no part of the claimed design.

1 Claim, 2 Drawing Sheets

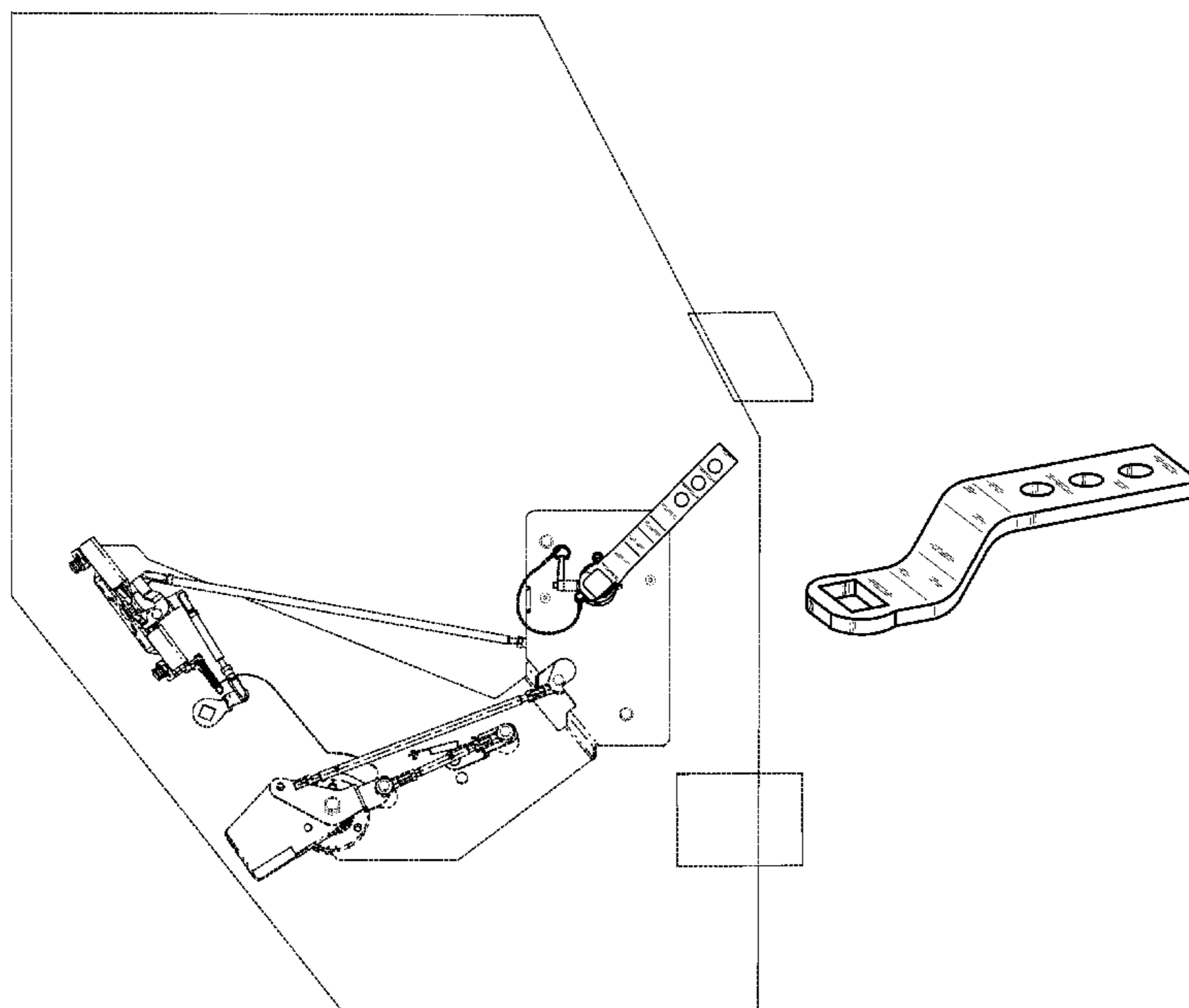

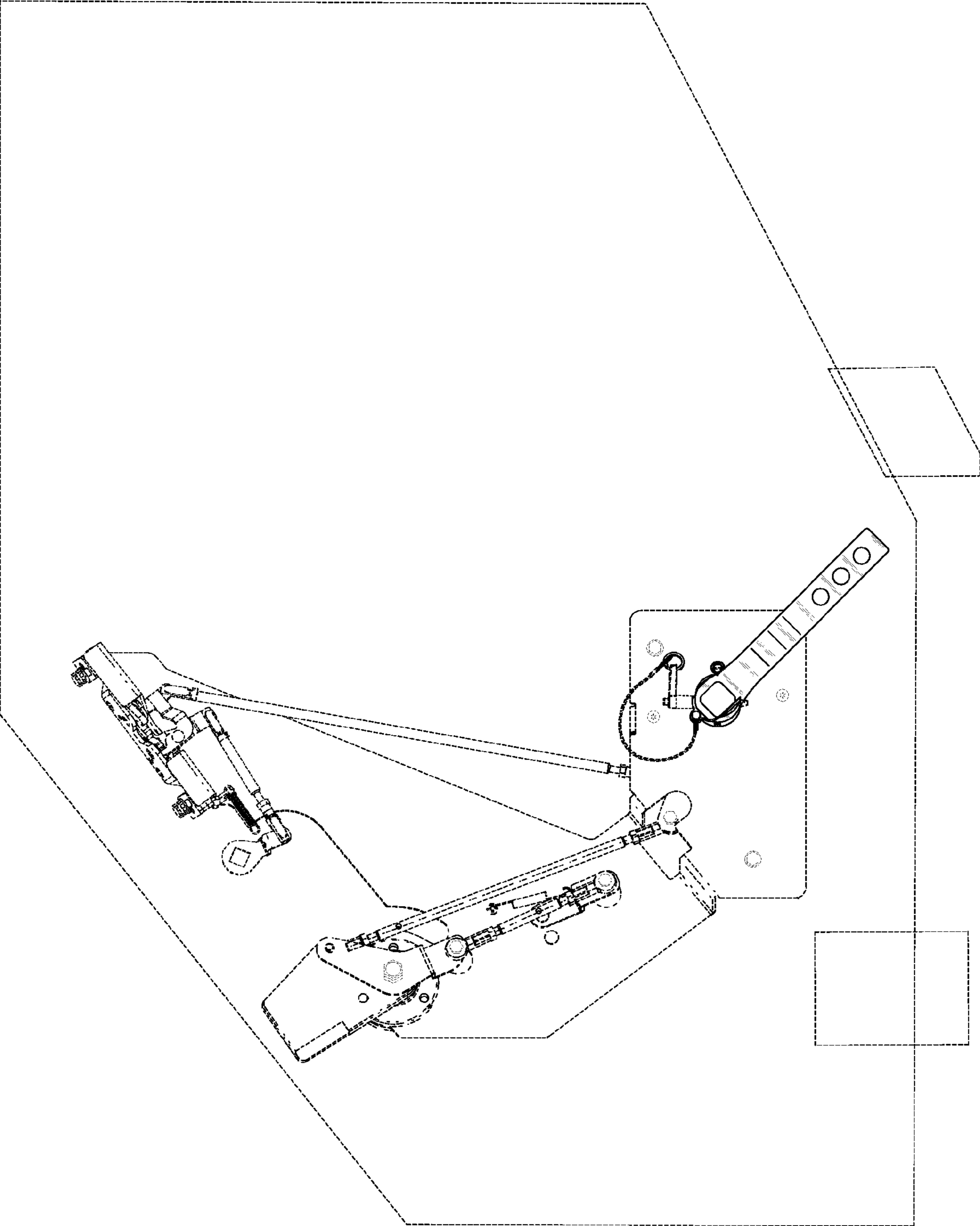

FIG. 1

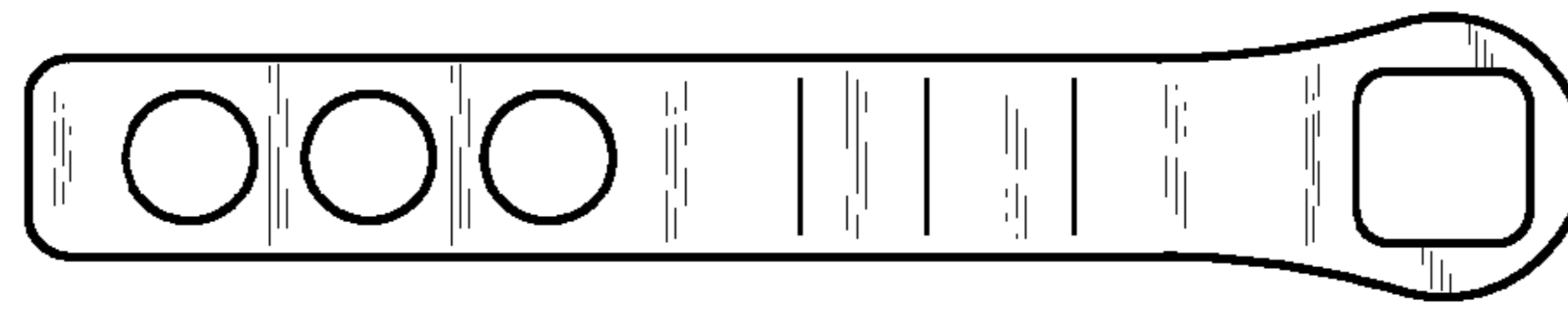

FIG. 2

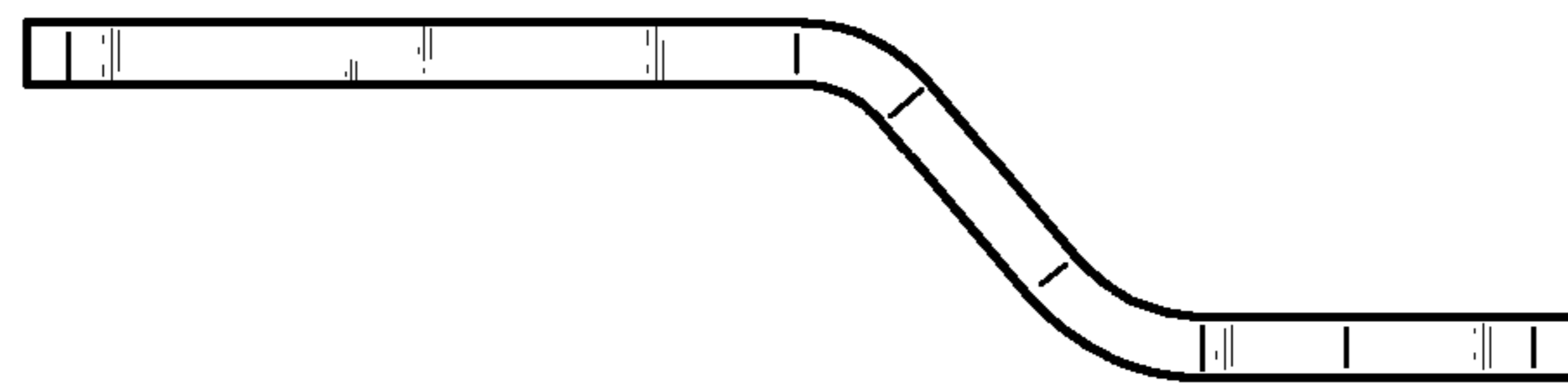

FIG. 3

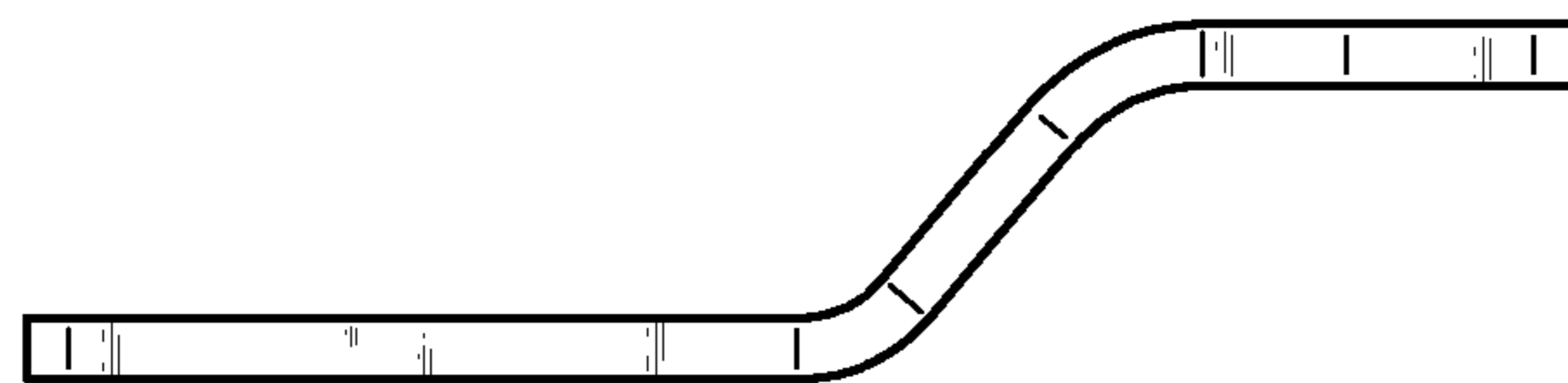

FIG. 4

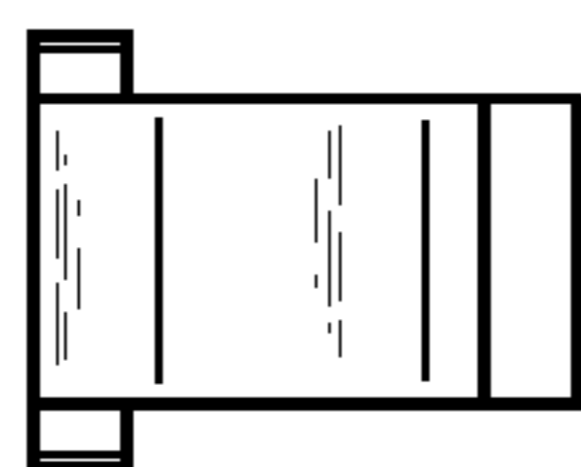

FIG. 5

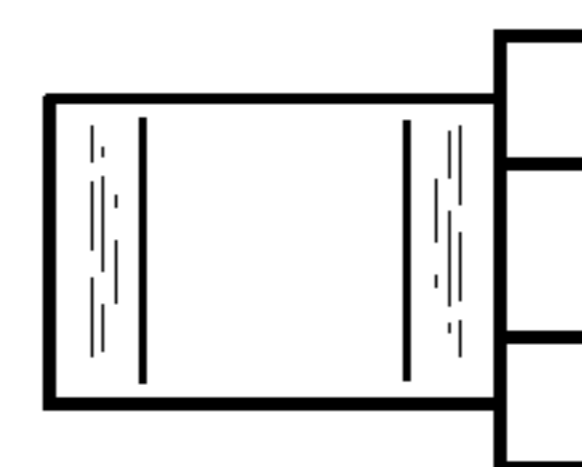

FIG. 6

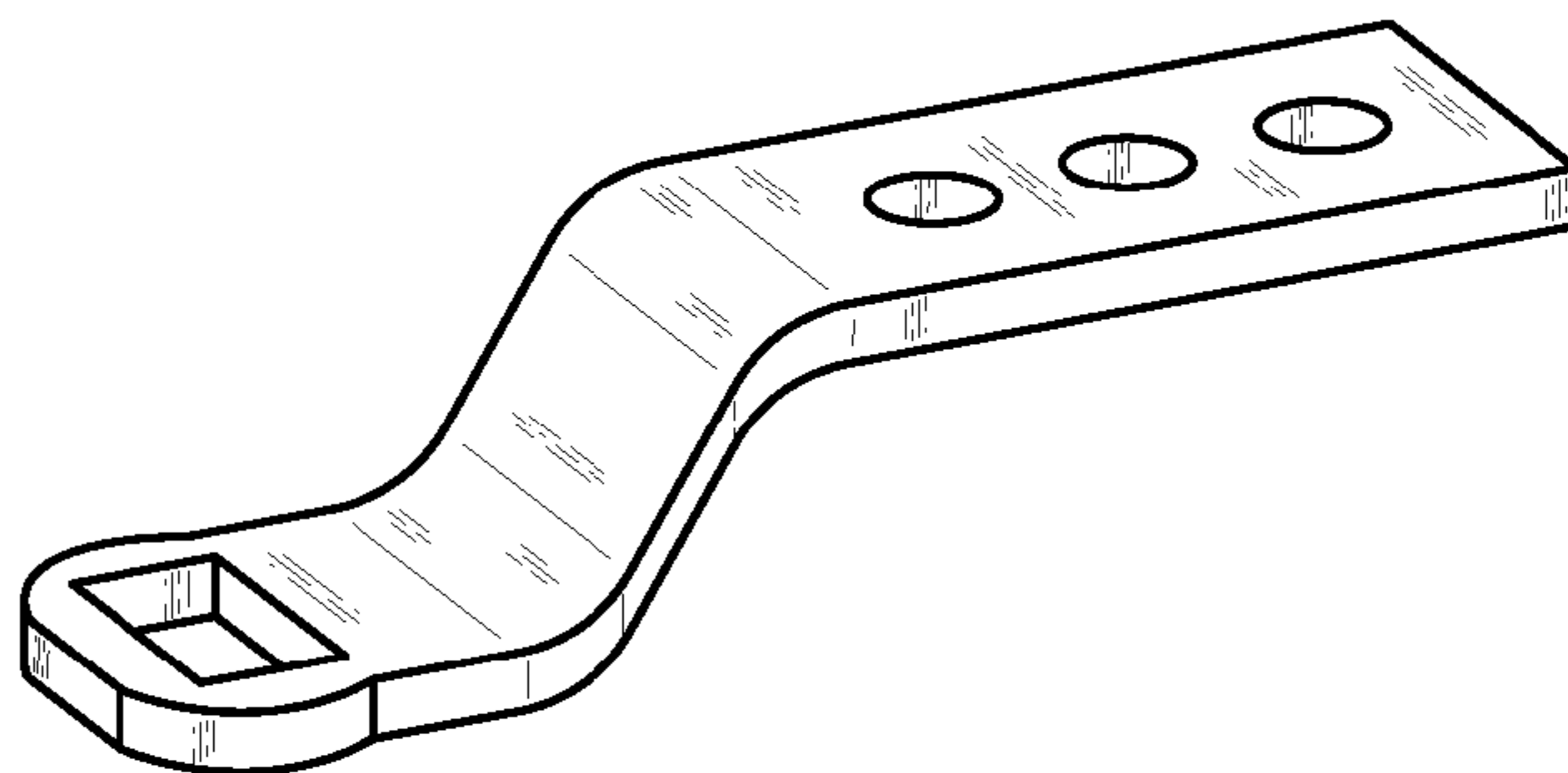

FIG. 7