



US00D615824S

(12) **United States Design Patent**
Tarrerrias

(10) **Patent No.:** **US D615,824 S**
(45) **Date of Patent:** **** May 18, 2010**

(54) **CUTLERY SET**

(75) Inventor: **Eric Tarrerrias**, Pont du Chateau (FR)

(73) Assignee: **Societe d'Exploitation Tarrerrias Bonjean**, Celles sur Durolle (FR)

(**) Term: **14 Years**

(21) Appl. No.: **29/341,421**

(22) Filed: **Aug. 5, 2009**

(30) **Foreign Application Priority Data**

Feb. 6, 2009	(EM)	001083497-0001
Feb. 6, 2009	(EM)	001083497-0002
Feb. 6, 2009	(EM)	001083497-0003
Feb. 6, 2009	(EM)	001083497-0004

(51) **LOC (9) Cl.** **07-03**

(52) **U.S. Cl.** **D7/645**

(58) **Field of Classification Search** D7/368,
D7/395, 401.2, 642-646, 649-654, 660-669,
D7/675-676, 683, 688-692, 695-696; D8/99;
30/137, 141-143, 147-150, 322-327, 329,
30/340, 342-346; 416/70 R

See application file for complete search history.

(56) **References Cited**

U.S. PATENT DOCUMENTS

D76,520 S * 10/1928 Brown D8/99

(Continued)

Primary Examiner—Caron Veynar

Assistant Examiner—Ricky Pham

(74) *Attorney, Agent, or Firm*—Stites & Harbison PLLC;
Douglas E. Jackson

(57) **CLAIM**

The ornamental design for a cutlery set, as shown and described.

DESCRIPTION

FIG. 1 is top view showing a fork of the cutlery set.

FIG. 2 is a bottom view of the fork.

FIG. 3 is a left side view of the fork, the right view side being a mirror image thereof.

FIG. 4 is a front view of the fork.

FIG. 5 is rear view of the fork.

FIG. 6 is a perspective front, bottom and right side view of the fork.

FIG. 7 is top view showing a spoon of the cutlery set.

FIG. 8 is a bottom view of the spoon.

FIG. 9 is a left side view of the spoon, the right view side being a mirror image thereof.

FIG. 10 is a front view of the spoon.

FIG. 11 is rear view of the spoon.

FIG. 12 is a perspective front, bottom and left side view of the spoon.

FIG. 13 is a right side view showing a knife of the cutlery set.

FIG. 14 is top view of the knife.

FIG. 15 is a bottom view of the knife.

FIG. 16 is a left side view of the knife.

FIG. 17 is a front view of the knife.

FIG. 18 is rear view of the knife.

FIG. 19 is a perspective front, bottom and left side view of the knife.

FIG. 20 is an enlarged view of a portion of the knife handle.

FIG. 21 is a left side view showing a sharp knife of the cutlery set.

FIG. 22 is top view of the sharp knife.

FIG. 23 is a bottom view of the sharp knife.

FIG. 24 is a right side view of the sharp knife.

FIG. 25 is a front view of the sharp knife.

FIG. 26 is rear view of the sharp knife; and,

FIG. 27 is a perspective front, bottom and left side view of the sharp knife.

The stippling on surfaces of FIGS. 21-24 and 27 are provided to show a different surface appearance therefor.

1 Claim, 8 Drawing Sheets

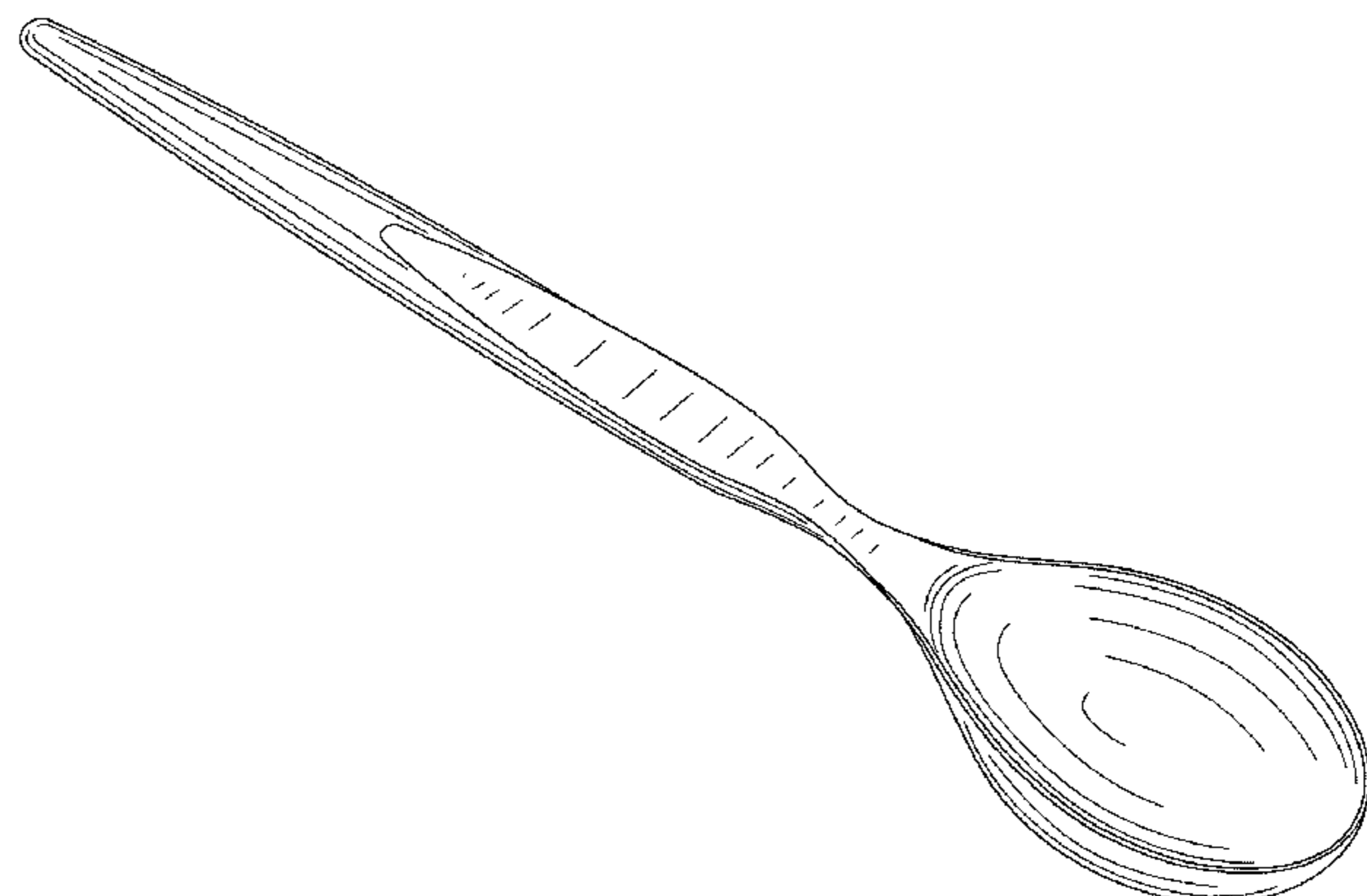
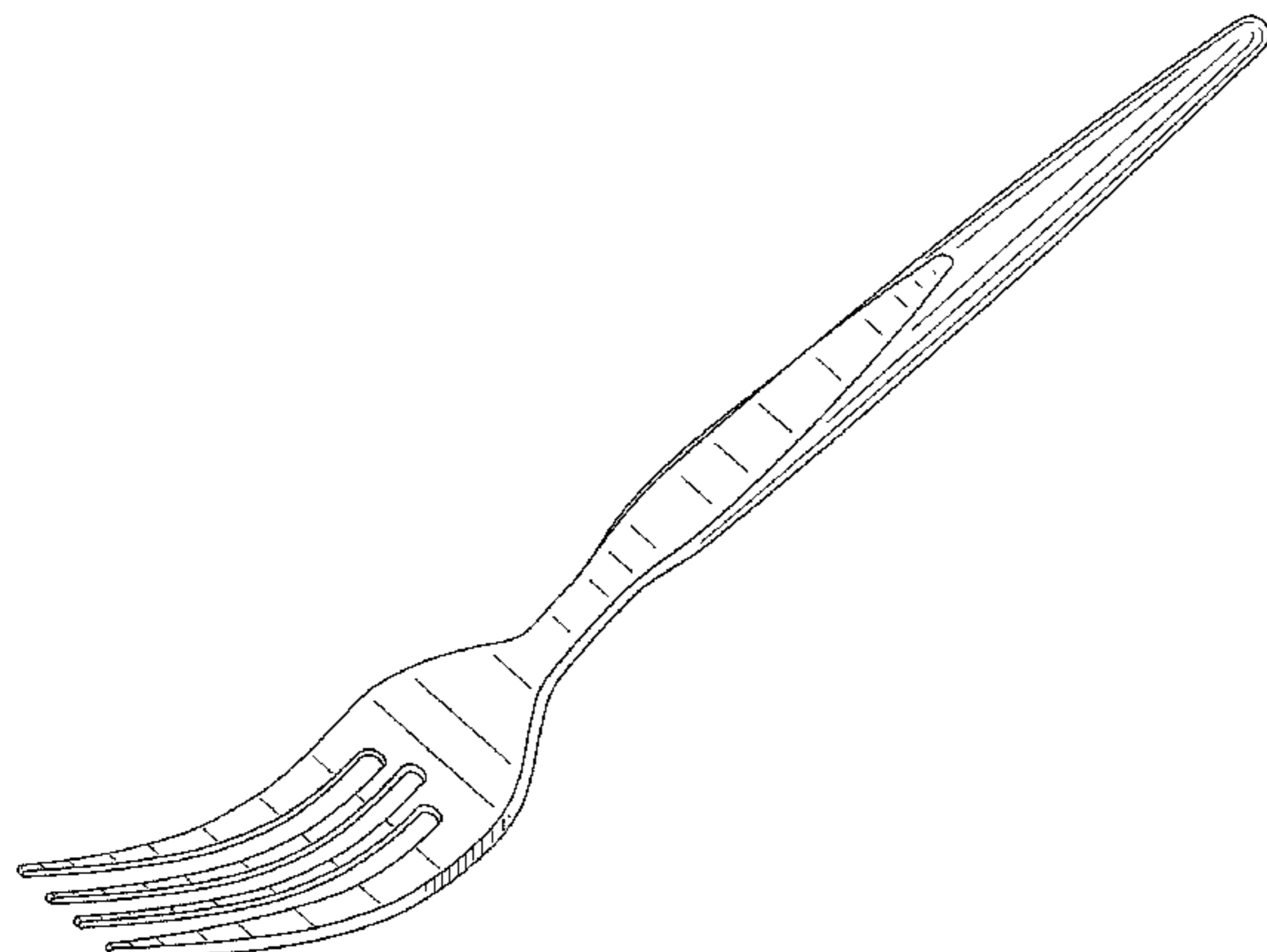

US D615,824 S

Page 2

U.S. PATENT DOCUMENTS

D208,724 S *	9/1967	Lea	D7/653	D356,723 S *	3/1995	Sakai	D8/99
D210,047 S *	1/1968	Manderfield	D7/662	D463,718 S *	10/2002	Richmond	D7/653
D212,908 S *	12/1968	Toffolon	D7/662	D496,562 S *	9/2004	Achenbach	D7/650
4,317,284 A *	3/1982	Prindle	30/340	D539,617 S *	4/2007	Verde	D7/653

* cited by examiner

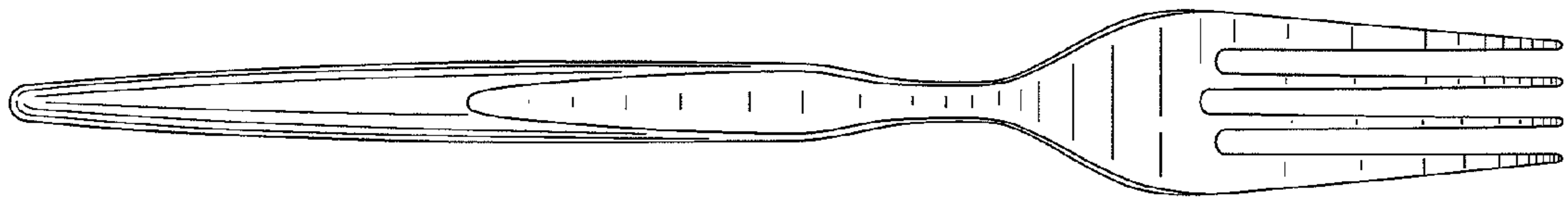

FIG. 1

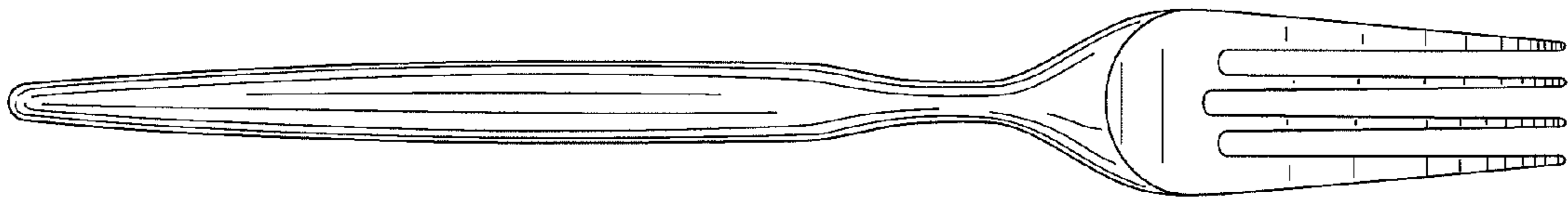

FIG. 2

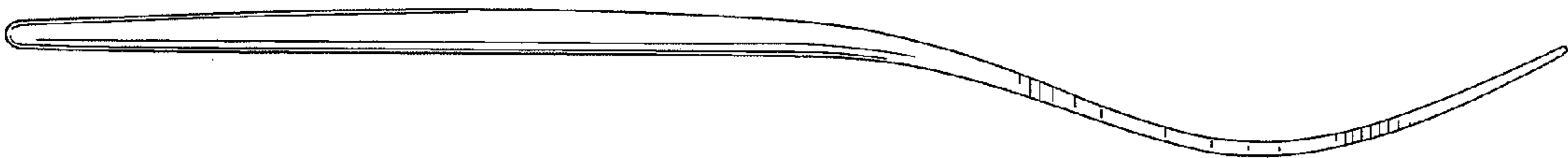

FIG. 3

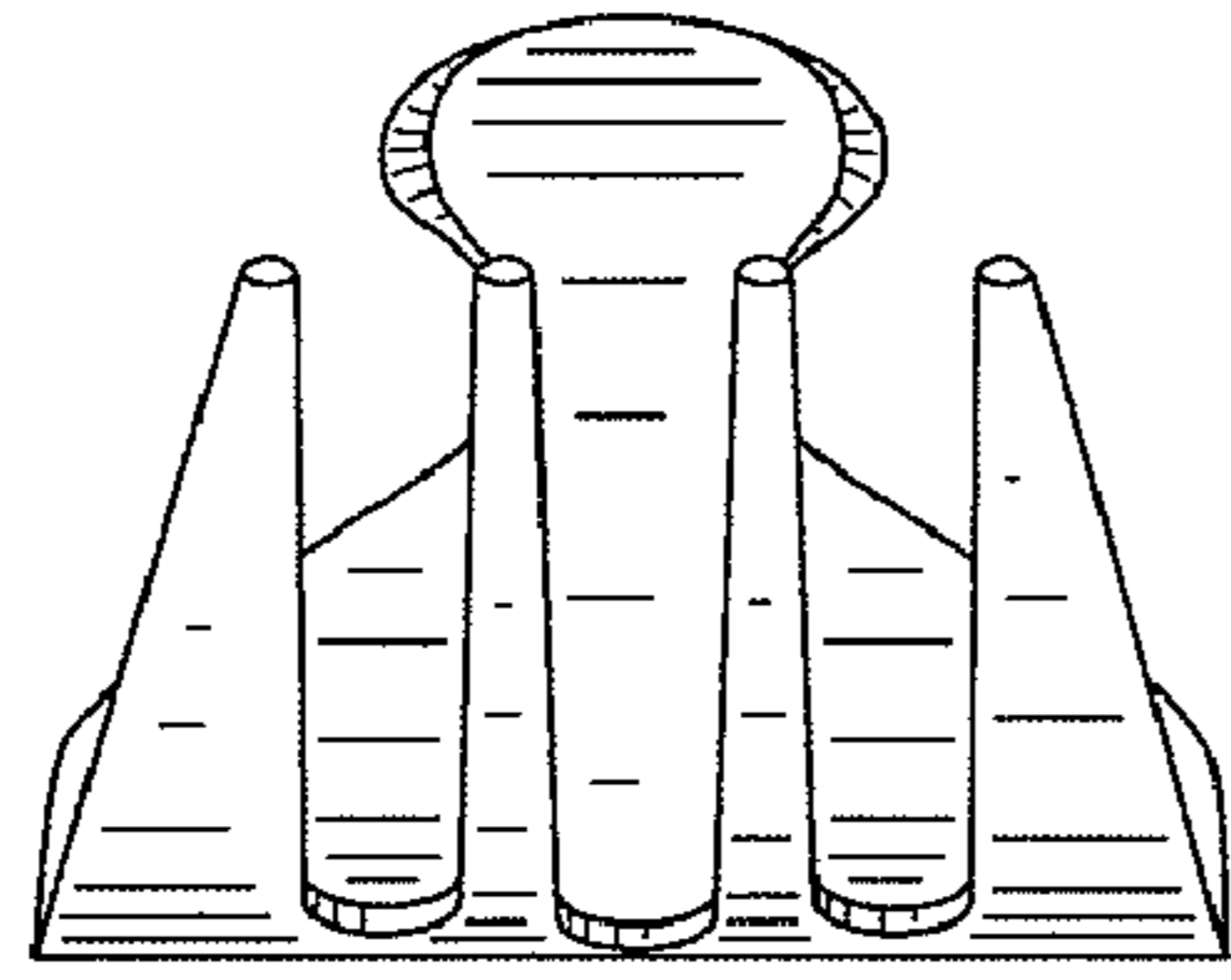

FIG. 4

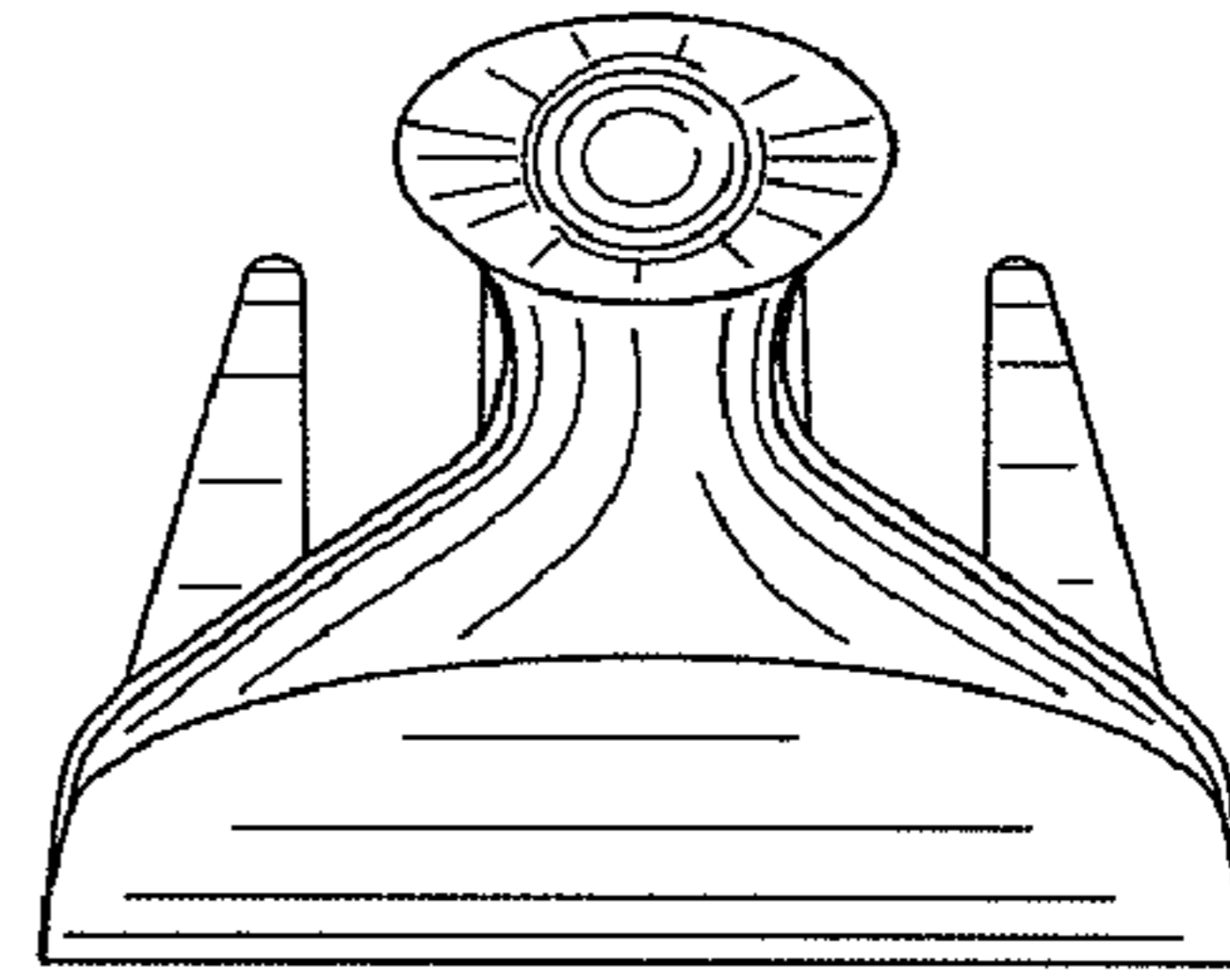

FIG. 5

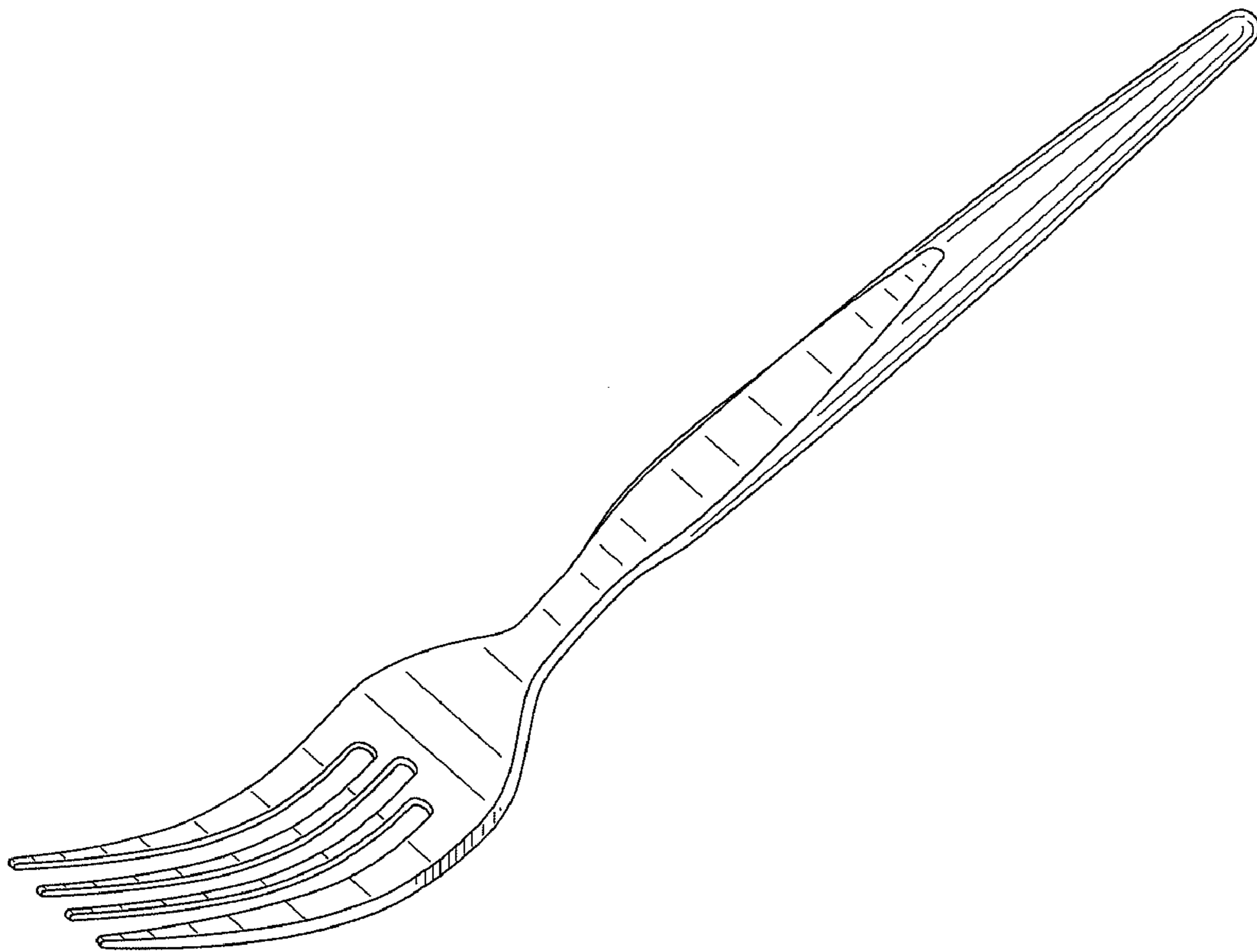

FIG. 6

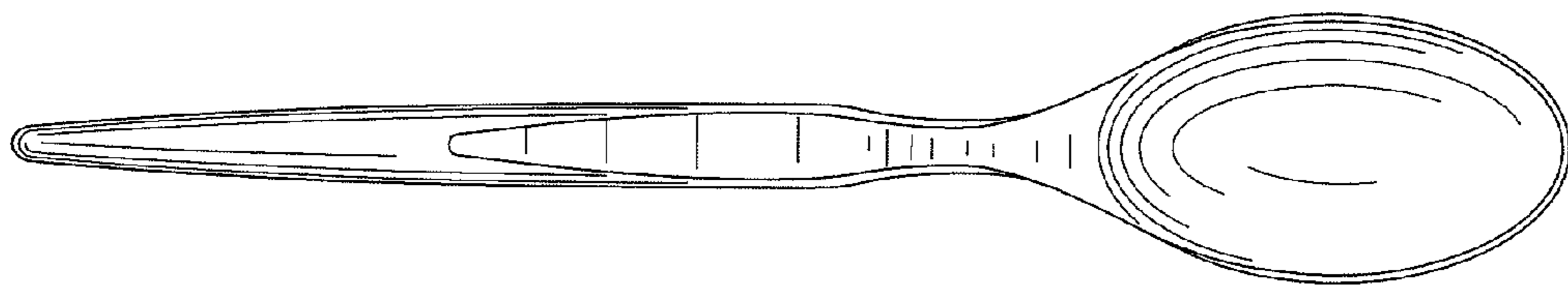

FIG. 7

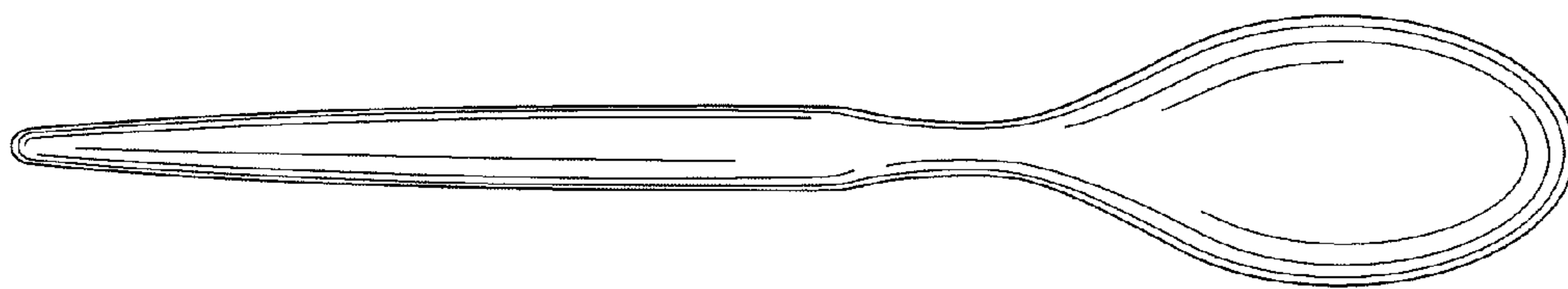

FIG. 8

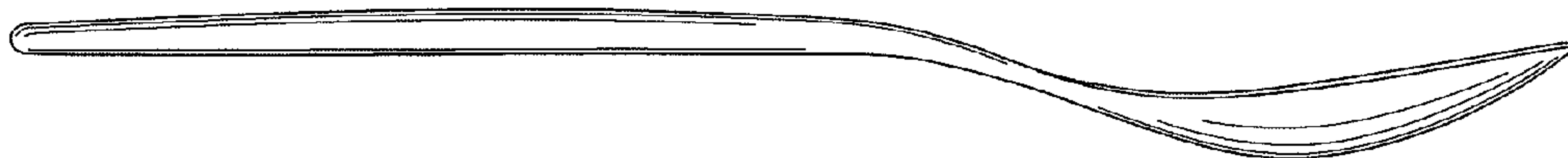

FIG. 9

FIG. 10

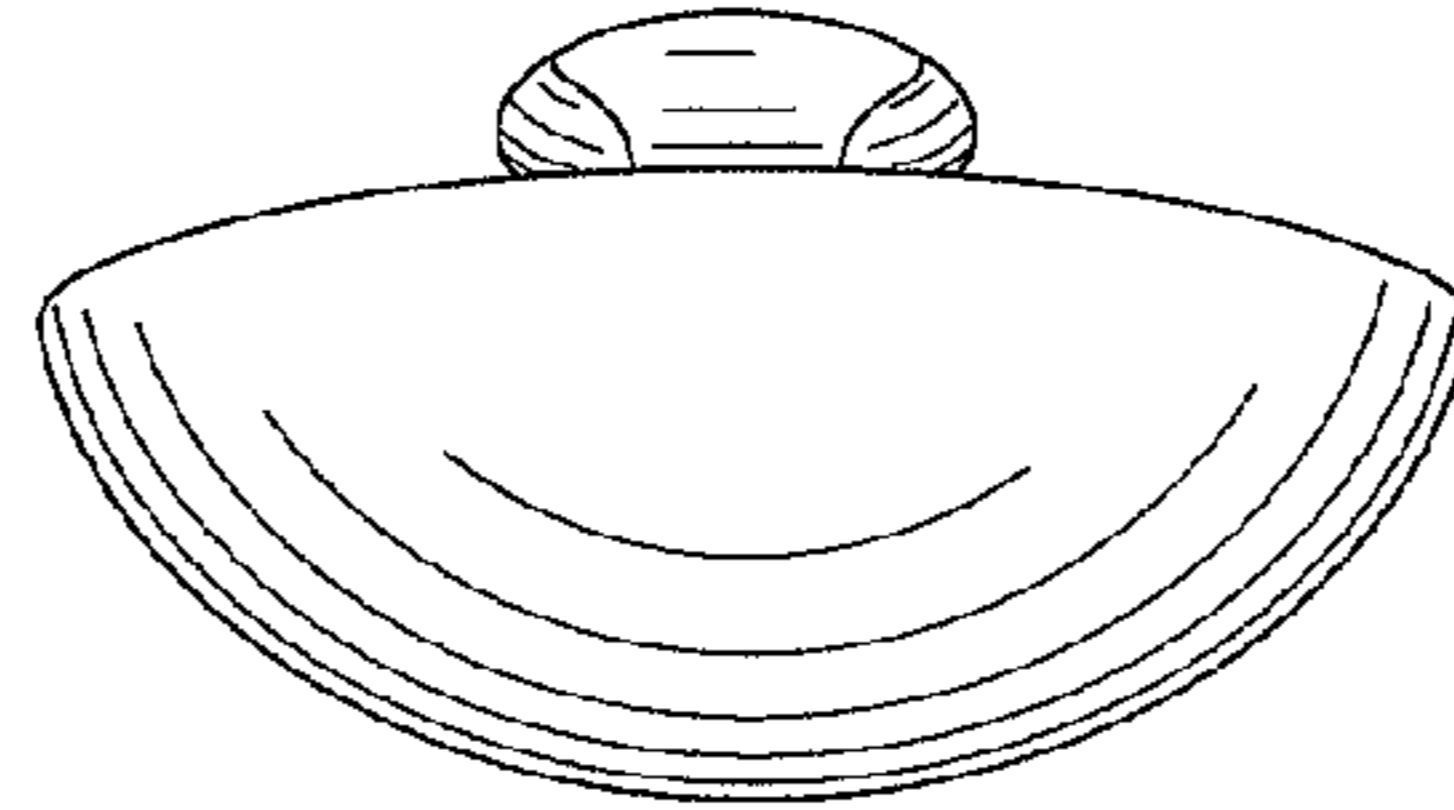

FIG. 11

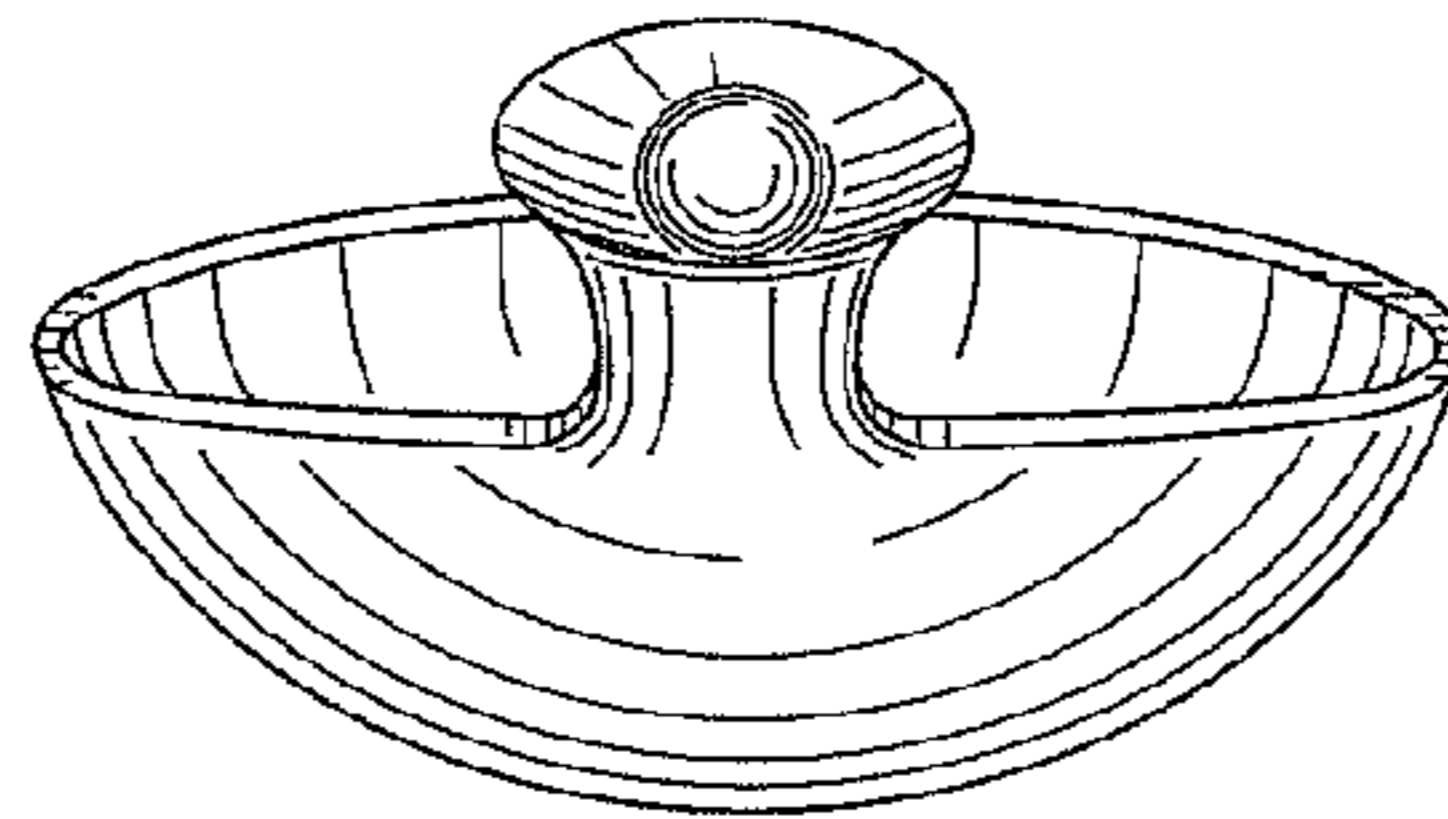
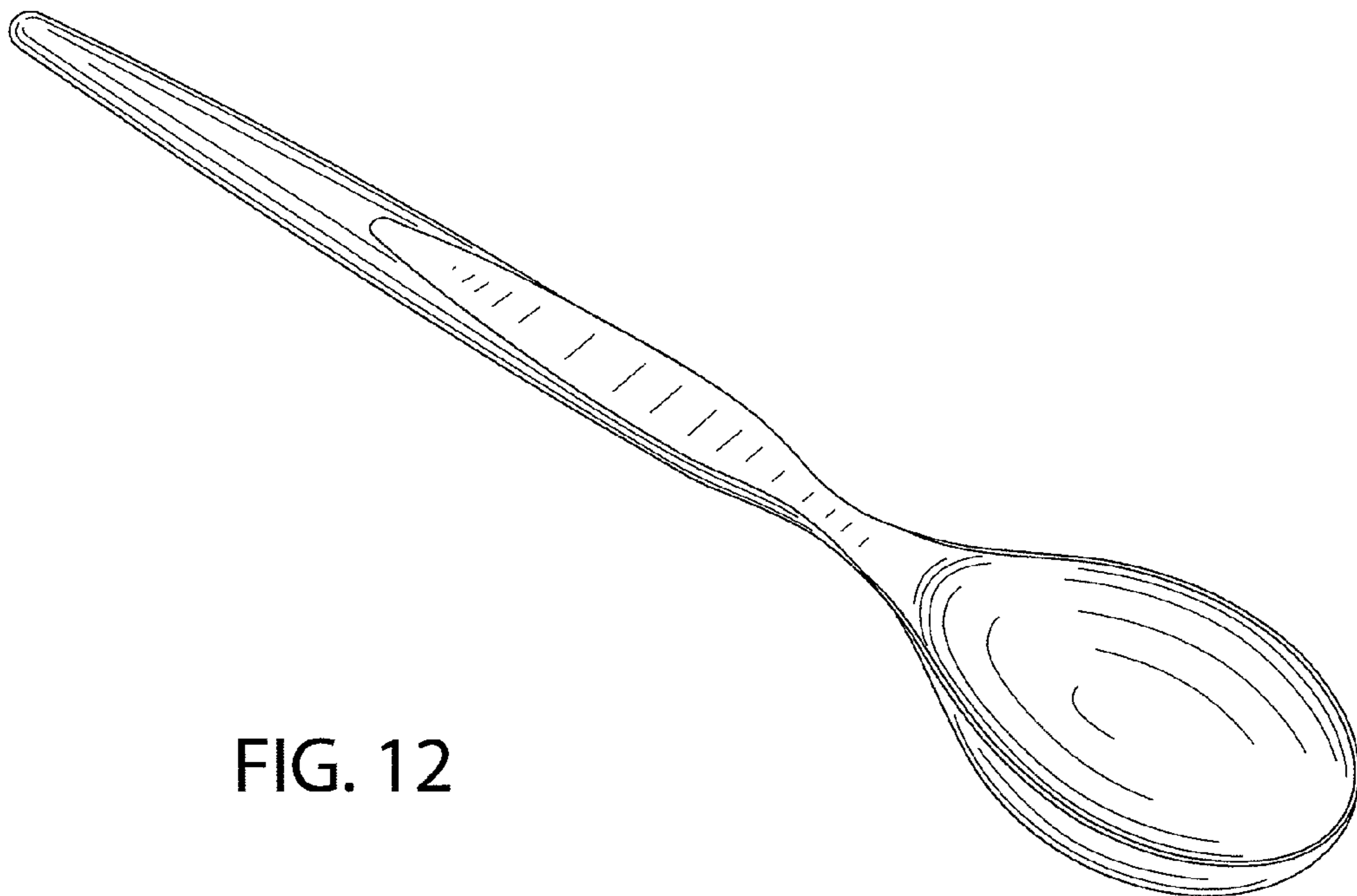

FIG. 12



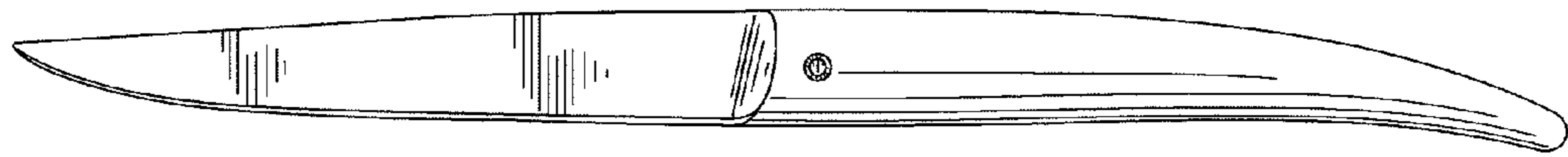

FIG. 13



FIG. 14



FIG. 15

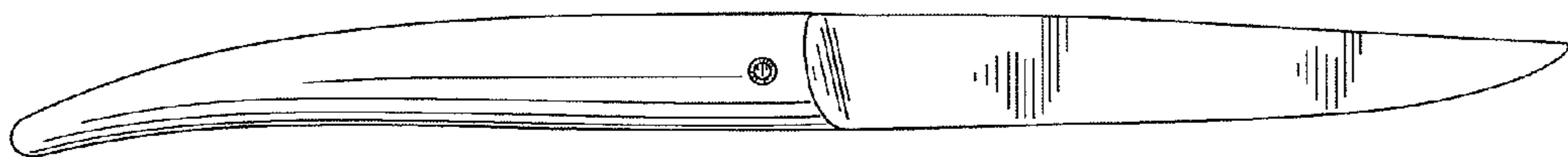

FIG. 16

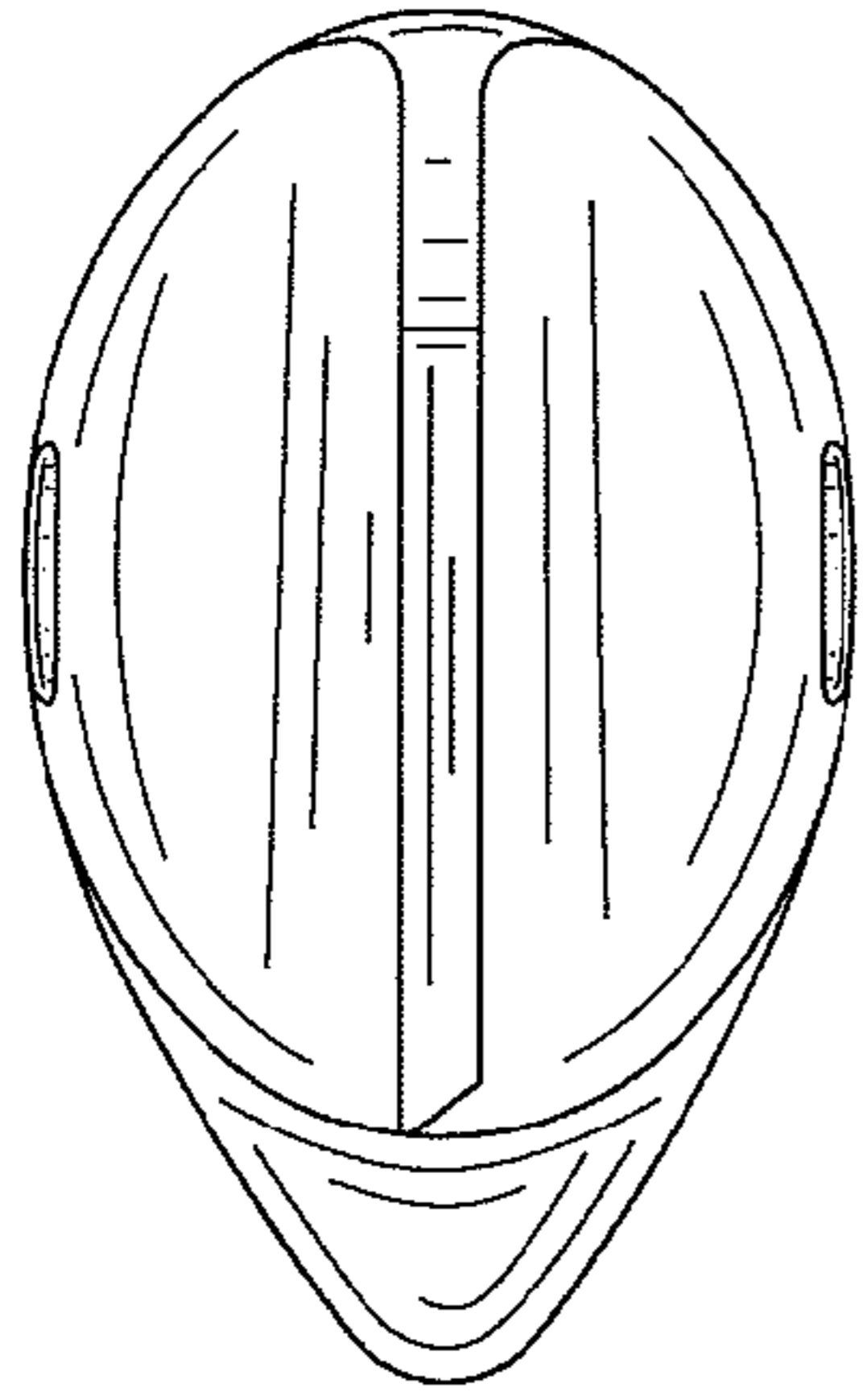

FIG. 17

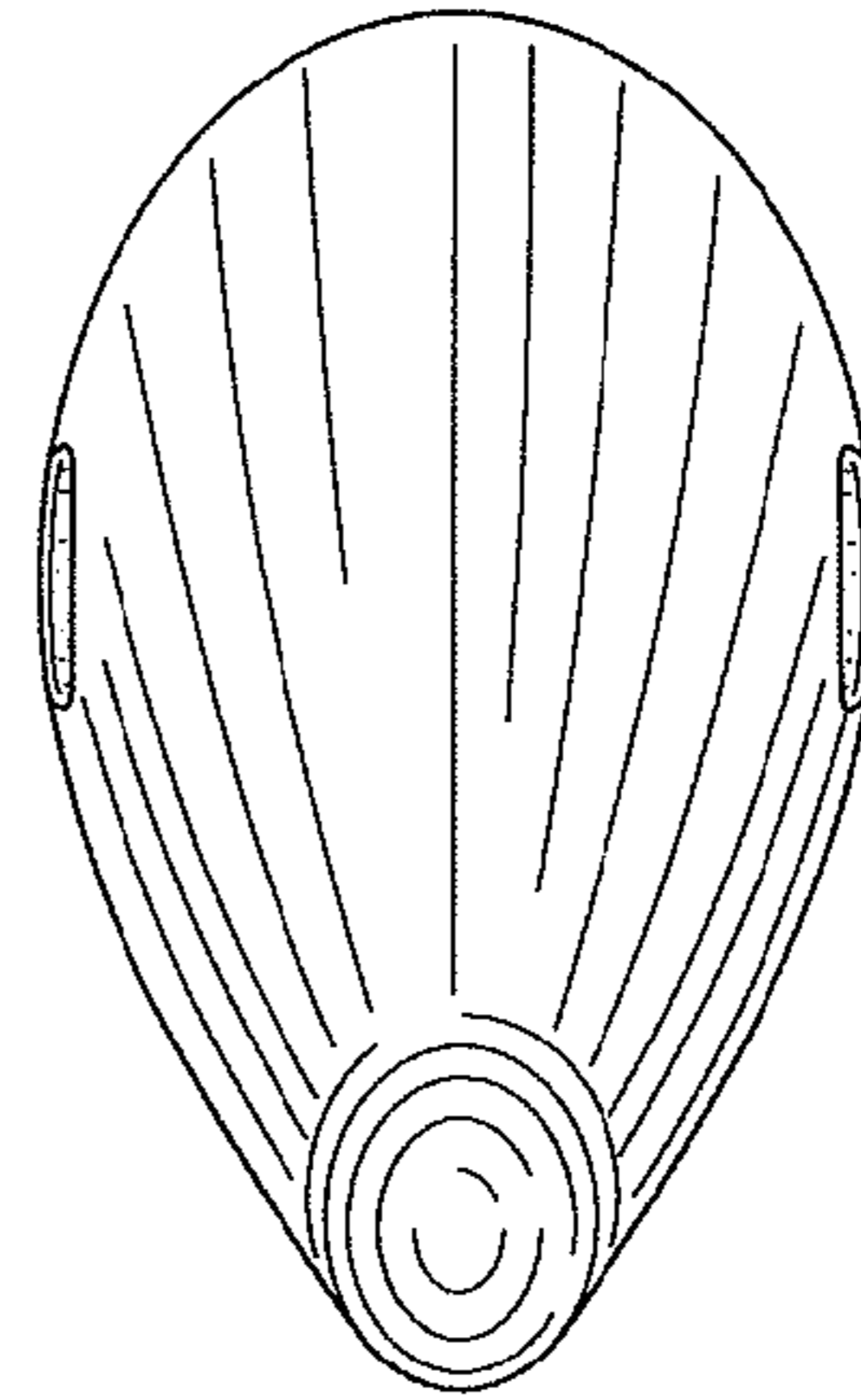

FIG. 18

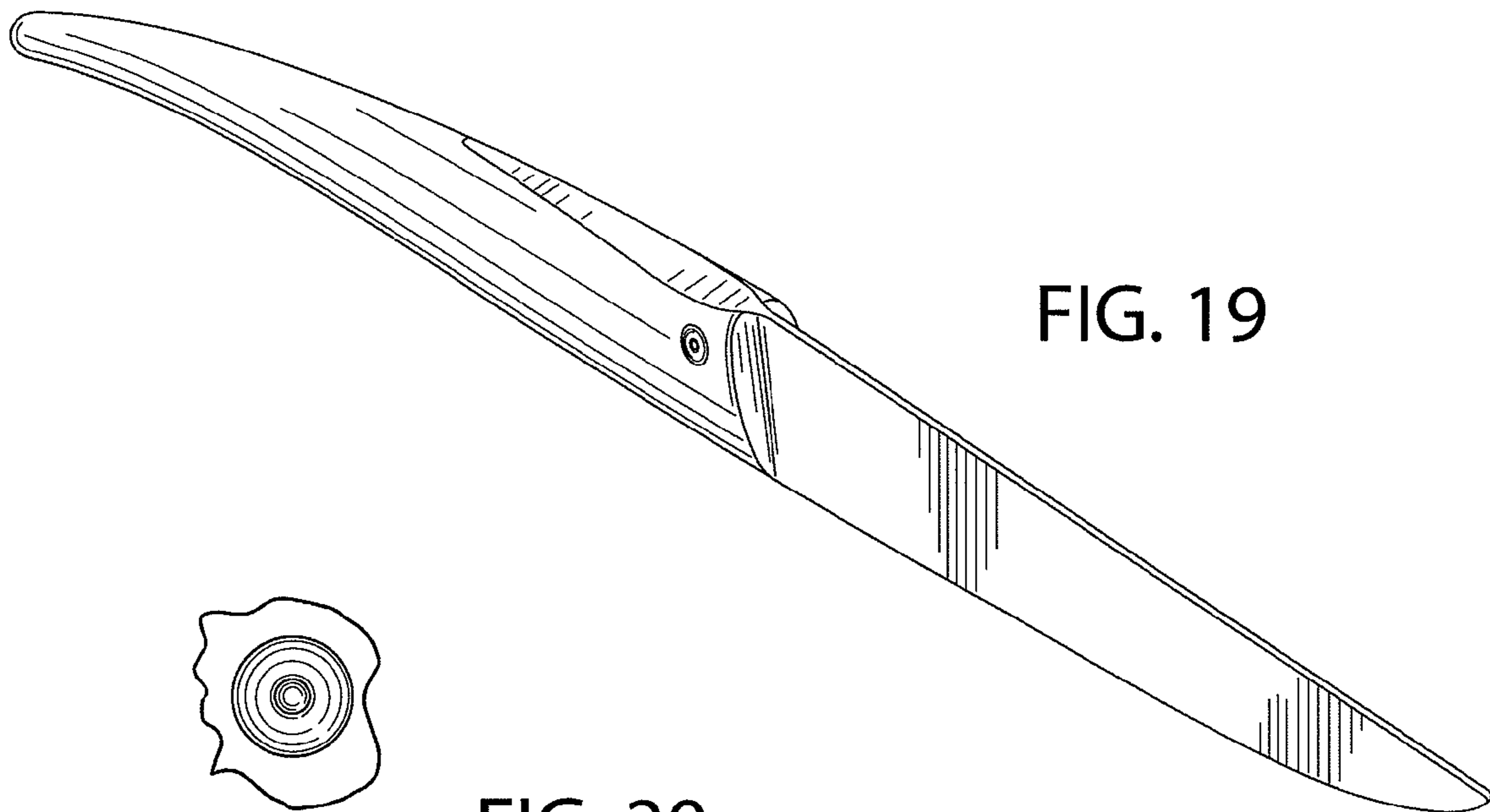

FIG. 19

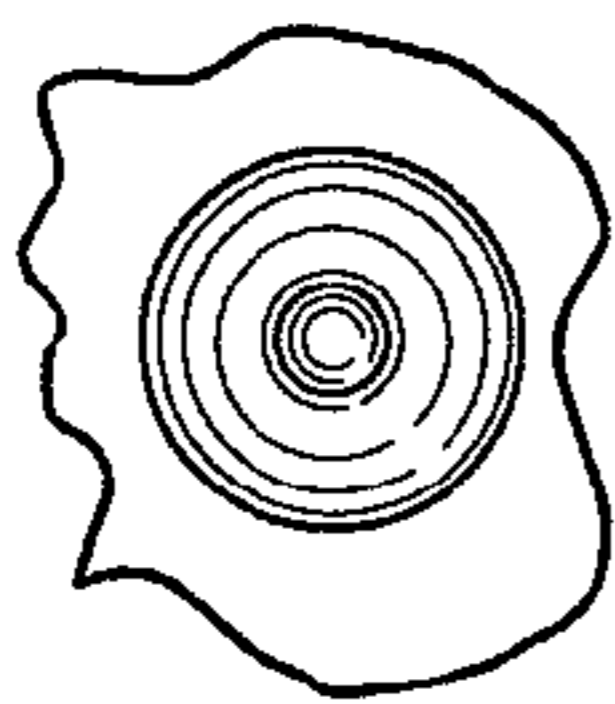

FIG. 20

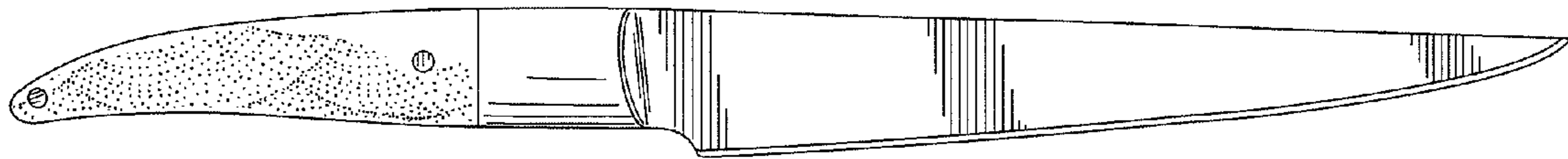

FIG. 21

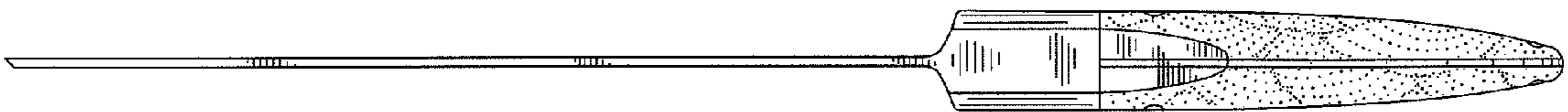

FIG. 22

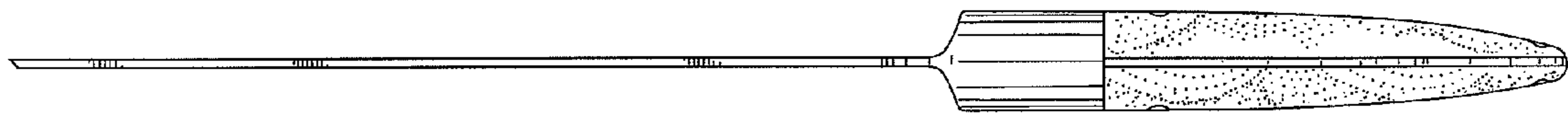

FIG. 23

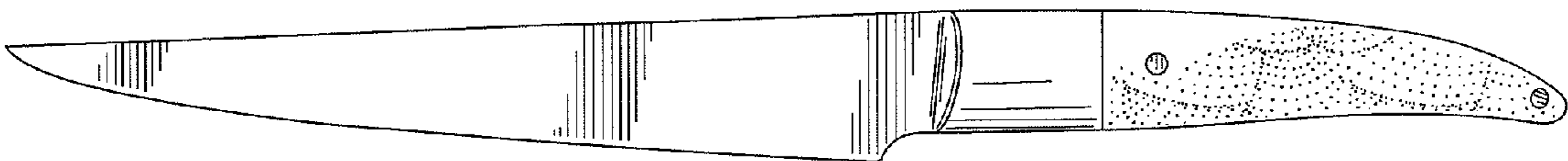

FIG. 24

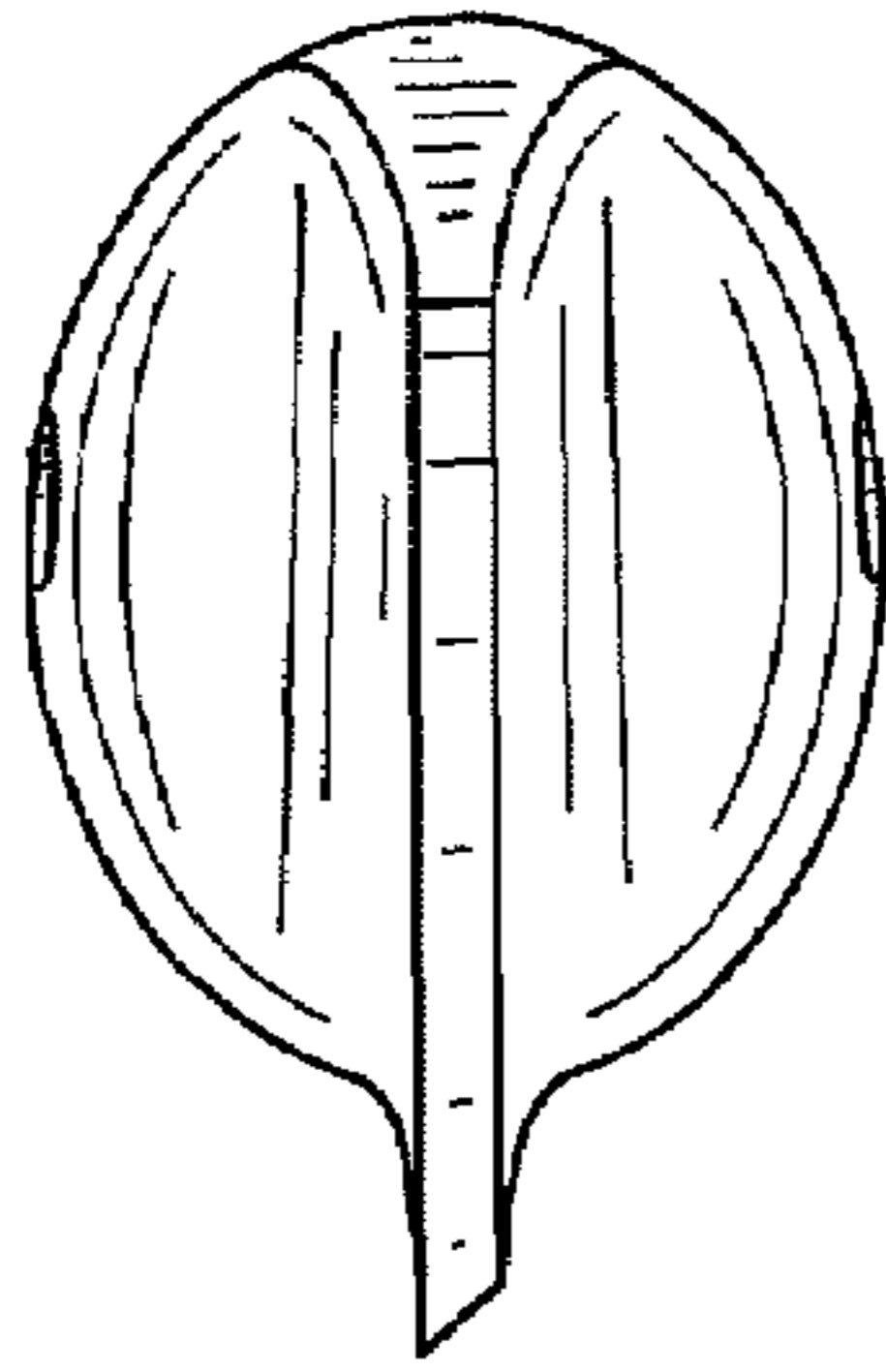

FIG. 25

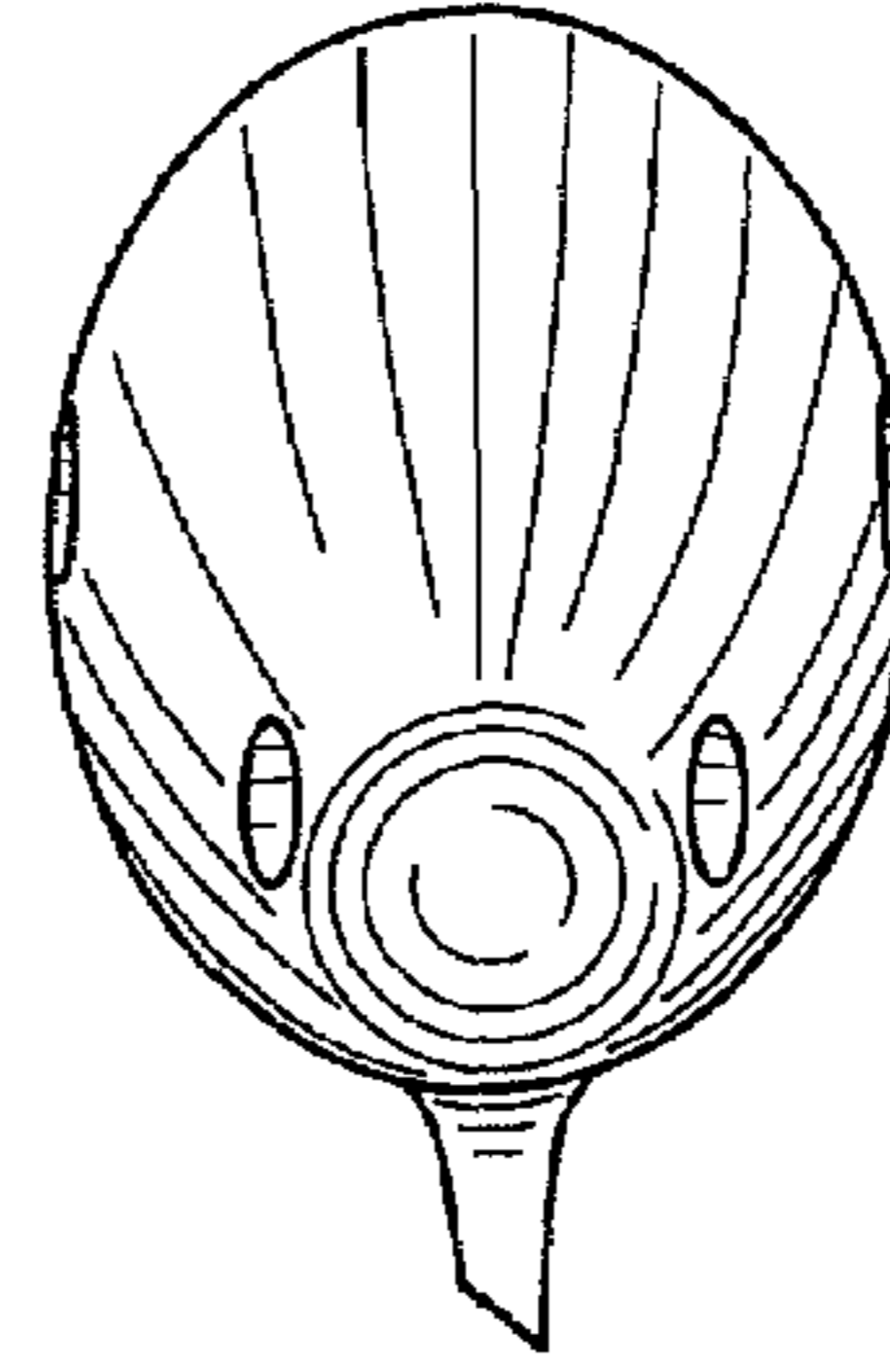

FIG. 26

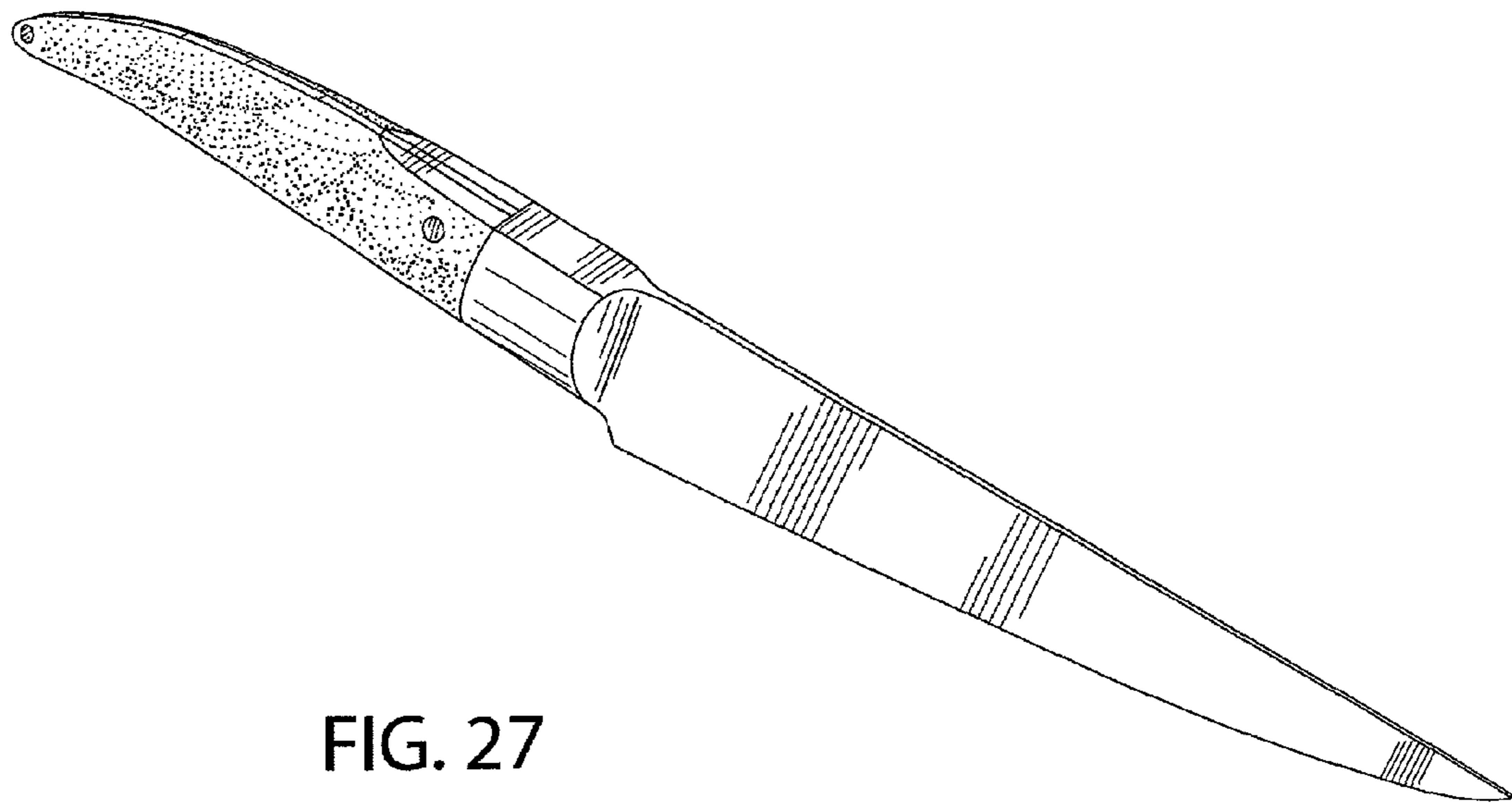

FIG. 27