



US00D615822S

(12) **United States Design Patent**
Klein

(10) **Patent No.:** **US D615,822 S**

(45) **Date of Patent:** **** May 18, 2010**

(54) **MICROWAVABLE FOOD CONTAINER WITH REMOVABLE COMPARTMENTS**

(76) Inventor: **Raymond F. Klein**, 6349 Chapel Pines Blvd., Wesley Chapel, FL (US) 33545

(**) Term: **14 Years**

(21) Appl. No.: **29/346,704**

(22) Filed: **Nov. 4, 2009**

Primary Examiner—Robert M Spear

Assistant Examiner—Cynthia Underwood

(74) *Attorney, Agent, or Firm*—QuickPatents, Inc.; Kevin Prince

(57) **CLAIM**

I claim the ornamental design for a microwavable food container with removable compartments, as shown and described.

Related U.S. Application Data

(62) Division of application No. 29/337,911, filed on Jun. 1, 2009, now Pat. No. Des. 604,992.

(51) **LOC (9) Cl.** **07-01**

(52) **U.S. Cl.** **D7/541; D7/392.1**

(58) **Field of Classification Search** D7/552.2, D7/741, 739, 737, 759, 761, 424, 425, 426, D7/553.8, 538, 555, 551.1, 566, 541, 585, D7/505, 571, 316, 356, 409, 667, 500, 543, D7/549, 554.3, 553.5, 553.3, 553.2, 553.1, D7/550, 614, 703, 629, 357, 550.1, 553.7; D3/315; D28/61; D9/666; 99/341; 220/575, 220/23.86, 23.4; 229/406; 206/583, 532
See application file for complete search history.

(56) **References Cited**

U.S. PATENT DOCUMENTS

261,811	A	7/1882	Coues	
1,601,991	A *	10/1926	Albert	132/287
3,101,864	A	8/1963	Glickman	
3,244,537	A	4/1966	Cease	
3,247,988	A	4/1966	Cease	
3,305,126	A *	2/1967	Cease	220/23.83
D214,523	S	6/1969	Stone	
3,501,044	A	3/1970	Stone	
3,595,425	A	7/1971	Eicholtz et al.	
D235,499	S *	6/1975	Day	D7/553.3
D236,691	S *	9/1975	Haase	D9/761
D253,628	S *	12/1979	Adamson	D7/553.2
4,360,148	A *	11/1982	Forbes, Jr.	229/125.12

(Continued)

DESCRIPTION

FIG. 1 is an exploded top perspective view of a microwavable food container with removable compartments;

FIG. 2 is an exploded bottom perspective view thereof;

FIG. 3 is a front elevational view of a tray thereof, the rear elevational view being a mirror image thereof;

FIG. 4 is a right-side elevational view thereof;

FIG. 5 is a left-side elevational view thereof;

FIG. 6 is a top plan view thereof;

FIG. 7 is a bottom plan view thereof;

FIG. 8 is a front elevational view of a removable compartment thereof, the rear elevational view being a mirror image thereof;

FIG. 9 is a left-side elevational view thereof, the right-side elevational view being a mirror image thereof;

FIG. 10 is a top plan view thereof;

FIG. 11 is a bottom plan view thereof;

FIG. 12 is a front elevational view of a cover thereof, the rear elevational view being a mirror image thereof;

FIG. 13 is a left-side elevational view thereof, the right-side elevational view being a mirror image thereof;

FIG. 14 is a top plan view thereof; and,

FIG. 15 is a bottom plan view thereof.

1 Claim, 4 Drawing Sheets

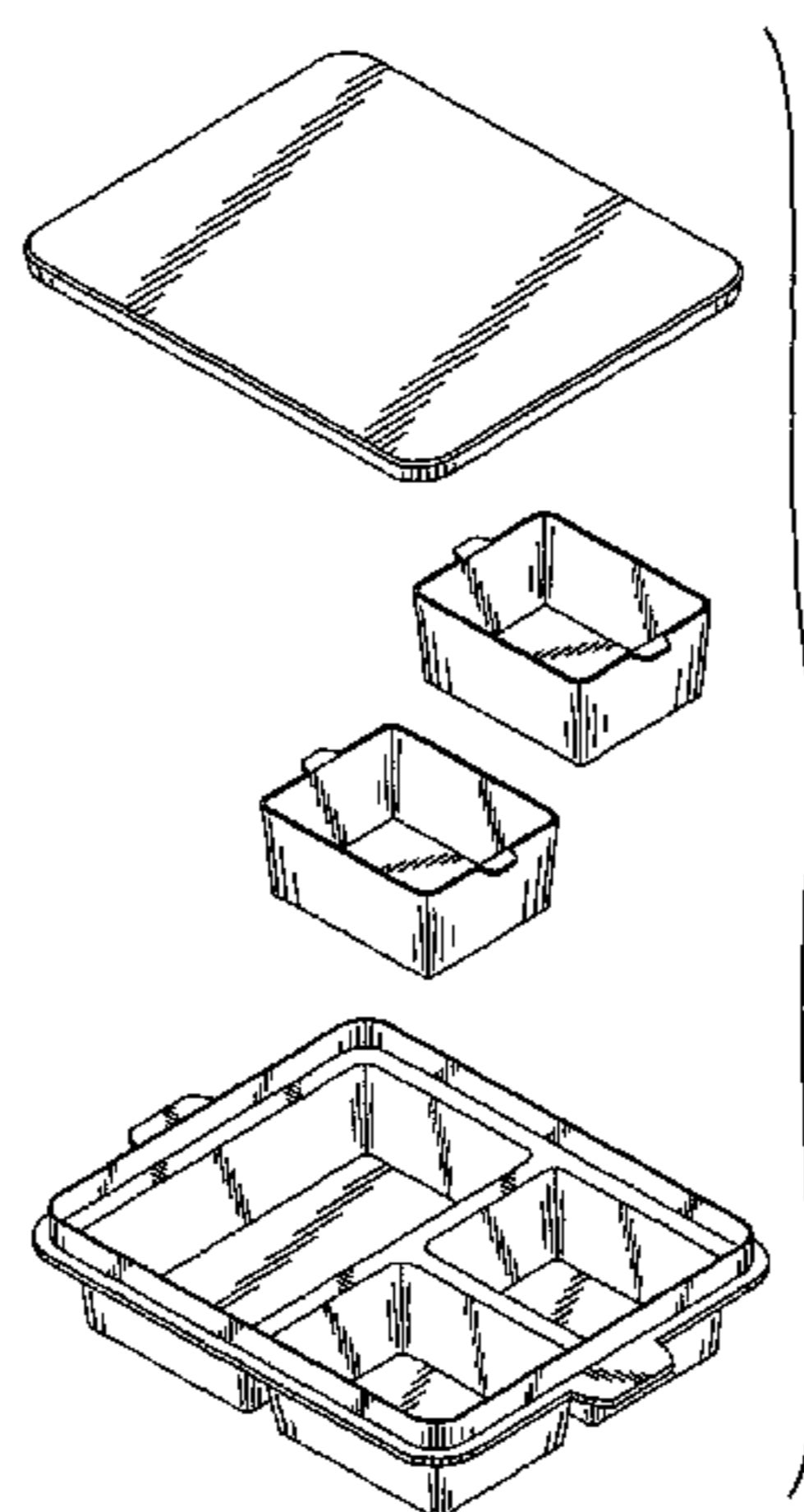

US D615,822 S

Page 2

U.S. PATENT DOCUMENTS							
4,574,174	A	3/1986	McGonigle	D428,767	S	8/2000	Turner, Jr.
4,741,441	A	5/1988	Keffeler	D436,854	S	1/2001	Feldmeier
D300,101	S	* 3/1989	Ritman	6,269,964	B1	8/2001	Turner, Jr.
D302,068	S	* 7/1989	Forbes et al.	D451,018	S	11/2001	Chen et al.
5,007,552	A	4/1991	Sage	D459,144	S	6/2002	Brady
5,011,018	A	4/1991	Keffeler	6,471,084	B2	* 10/2002	Erb
D318,207	S	7/1991	Anderson	D489,579	S	5/2004	Wright
5,167,973	A	12/1992	Snyder	D494,857	S	8/2004	Chen et al.
5,183,159	A	2/1993	Hojnacki	D539,666	S	* 4/2007	Chou
D339,030	S	9/1993	Bitel, Sr.	D552,487	S	10/2007	Chou
D352,203	S	11/1994	Campbell	7,337,943	B2	3/2008	Johns
5,386,922	A	2/1995	Jordan	D568,111	S	5/2008	Epstein
D376,953	S	12/1996	Dunn	D573,409	S	7/2008	Lovett
5,579,941	A	12/1996	Romick	D575,582	S	8/2008	Geens
5,727,679	A	3/1998	Newarski	D578,387	S	* 10/2008	Lovett
5,944,177	A	* 8/1999	Nemoto	D586,623	S	2/2009	Dunn
			206/232	D600,501	S	* 9/2009	Bizzell et al.
							D7/541

* cited by examiner

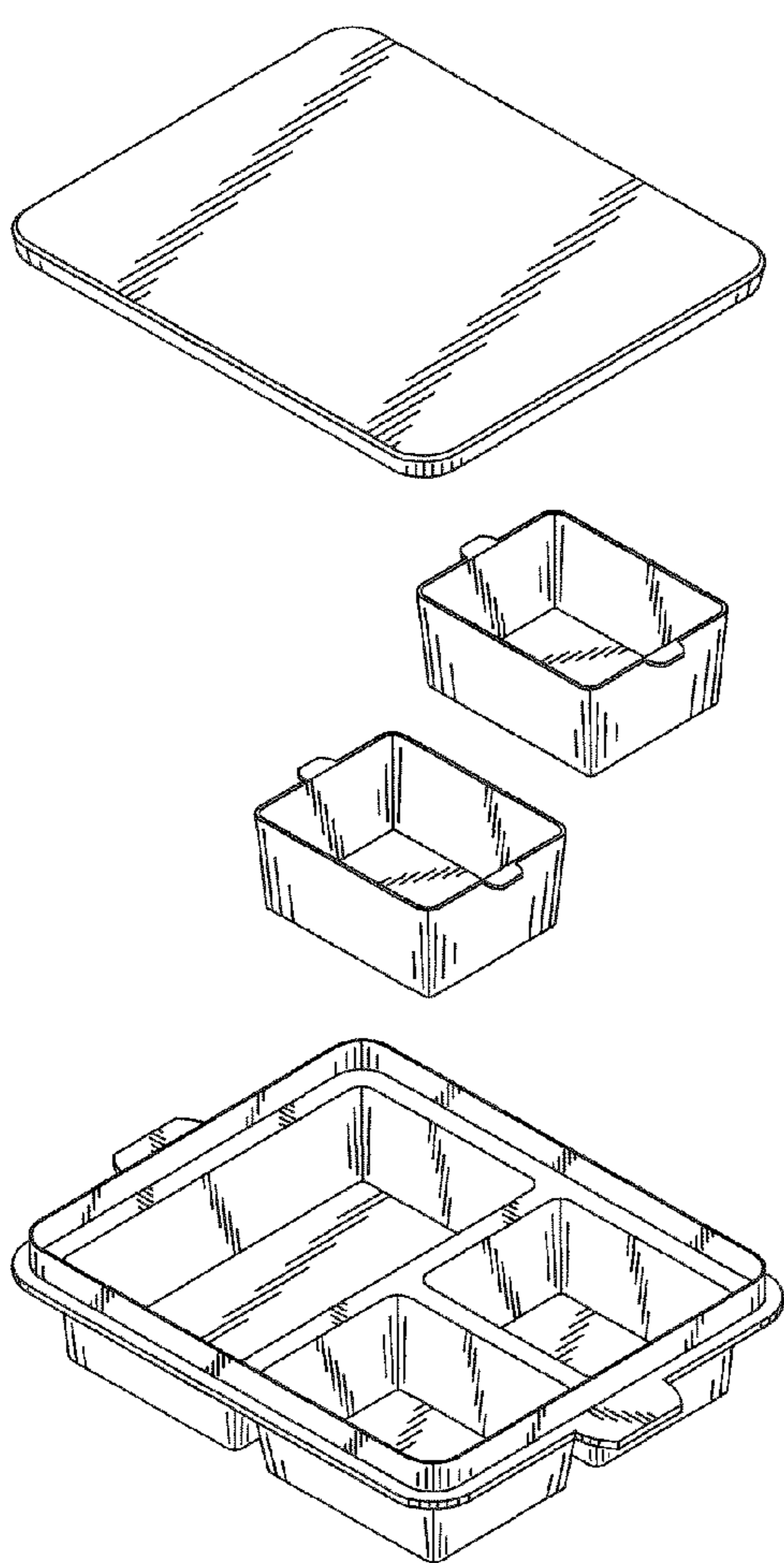

FIG. 1

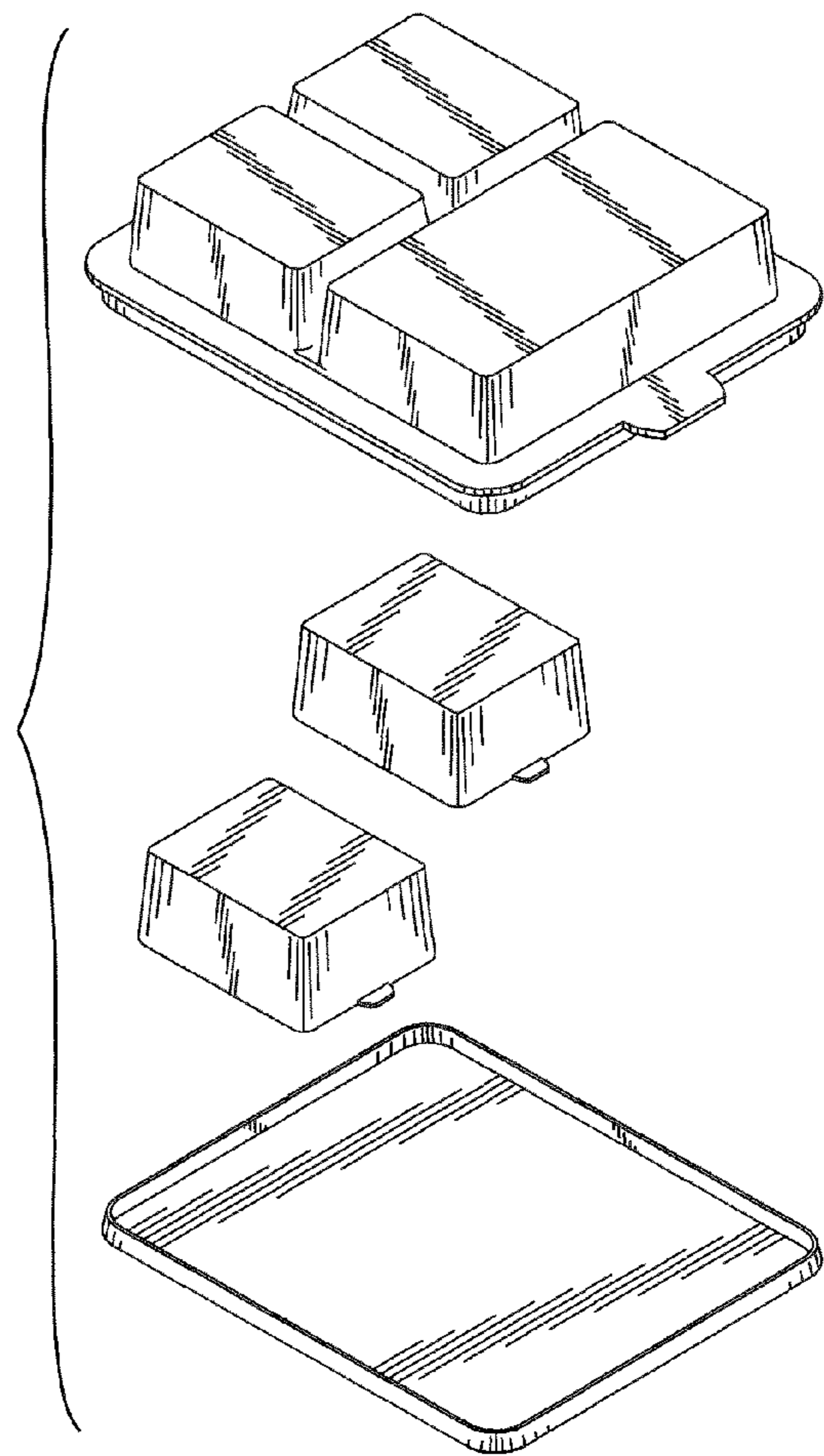

FIG. 2

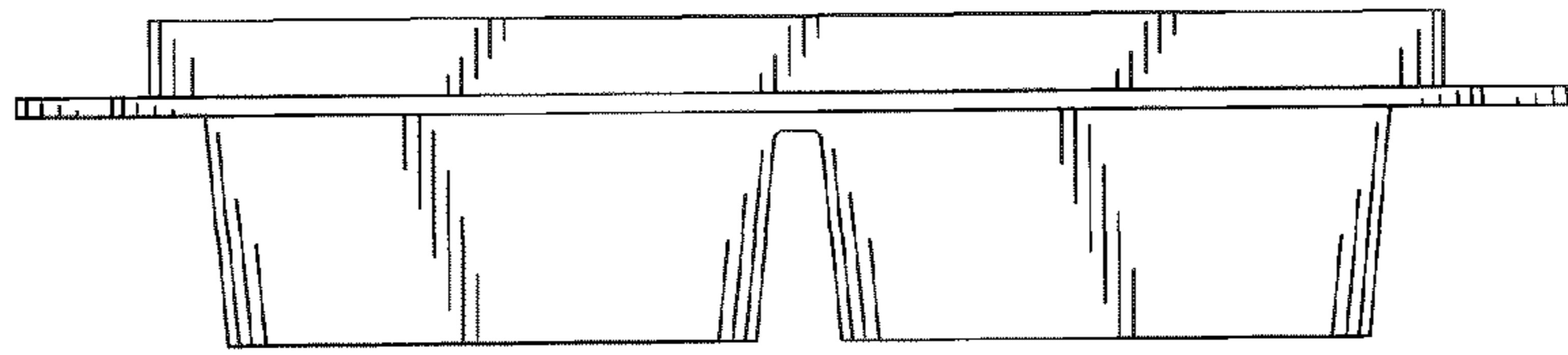

FIG. 3

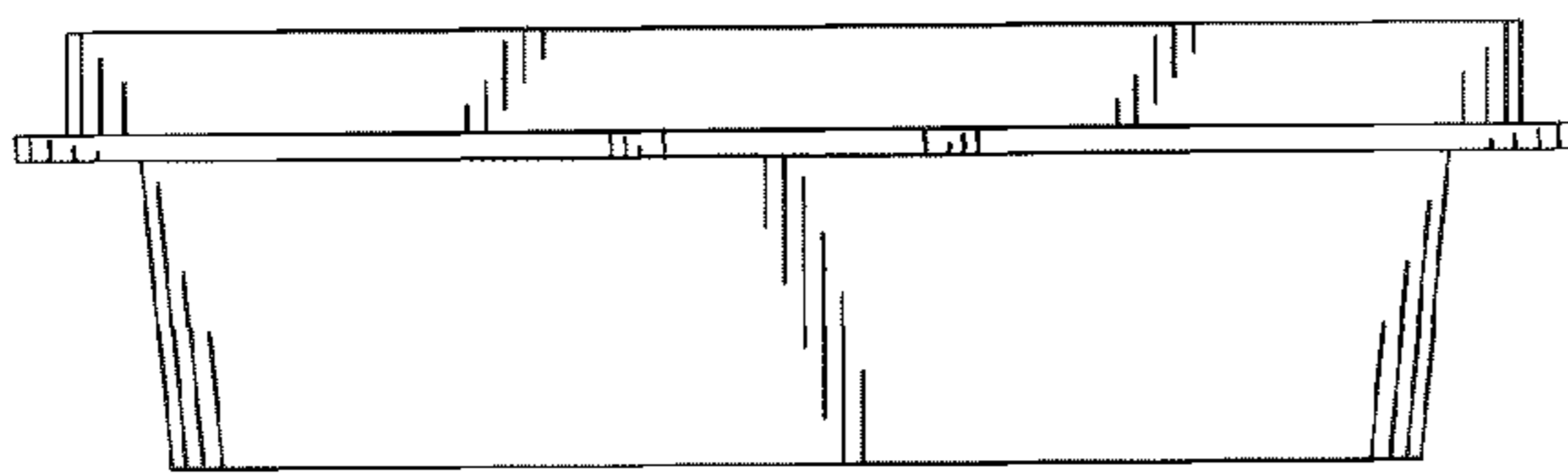

FIG. 4

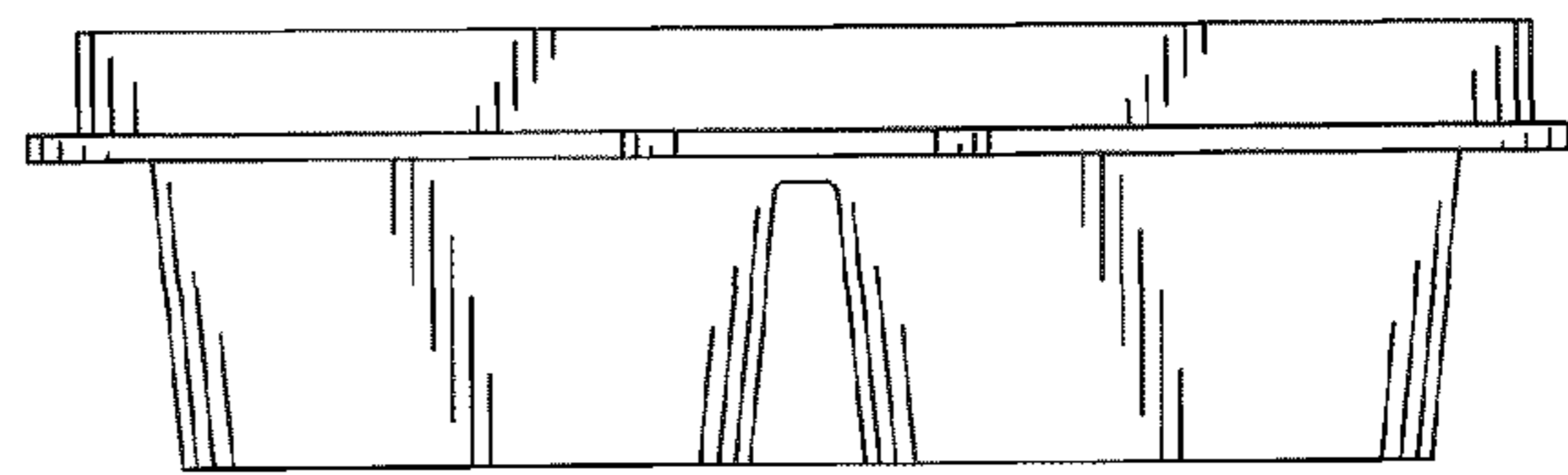

FIG. 5

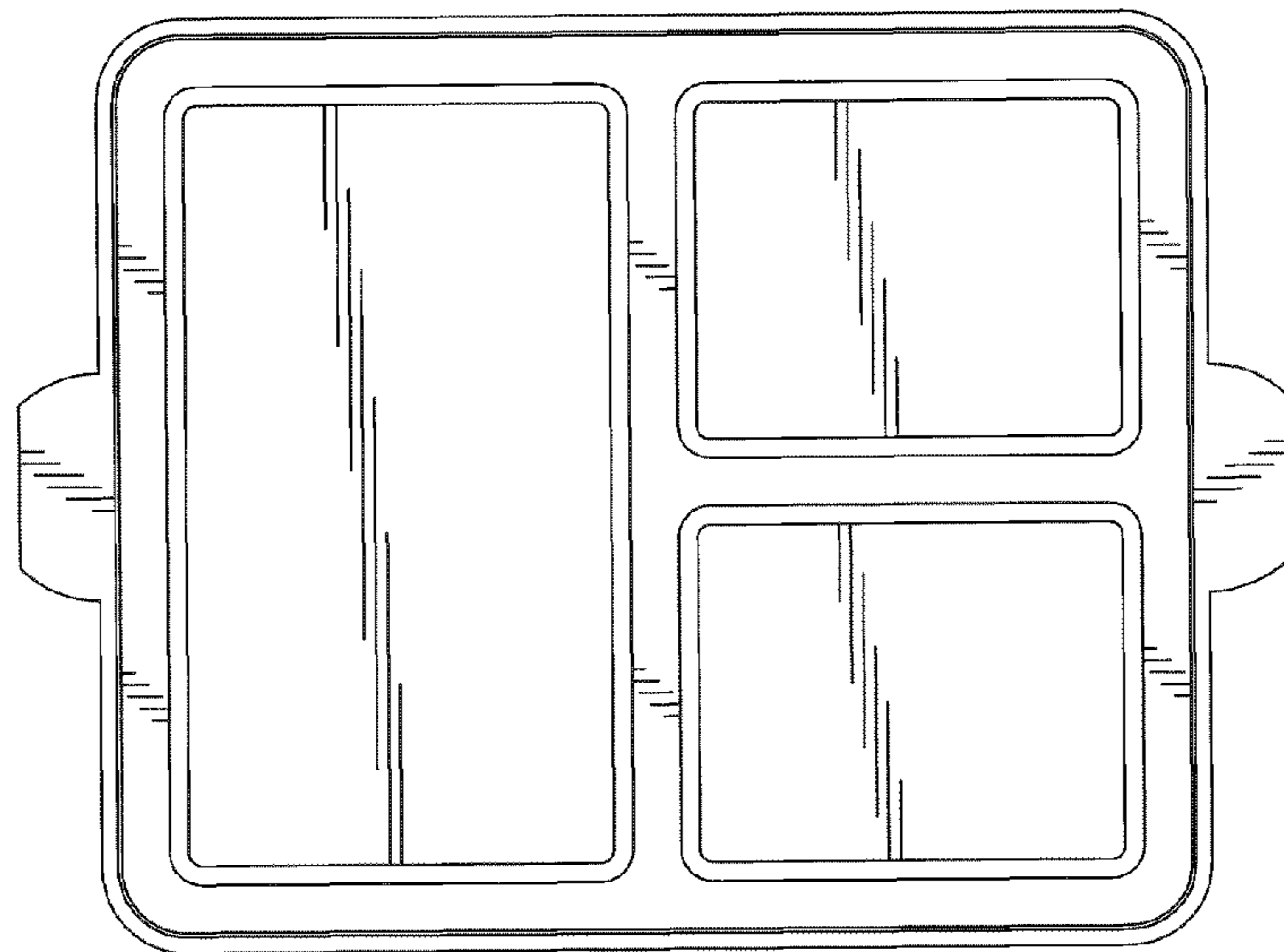

FIG. 6

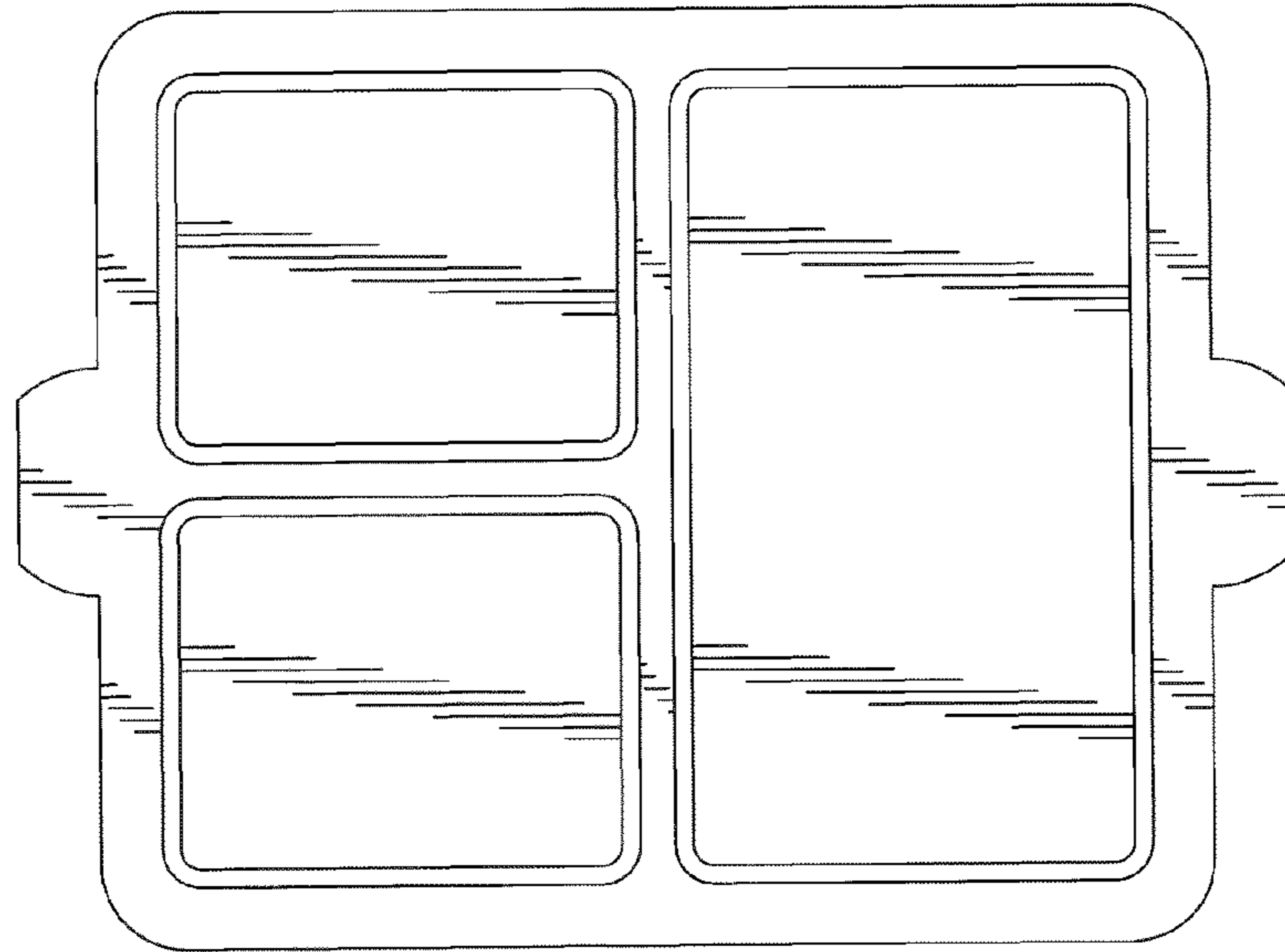

FIG. 7

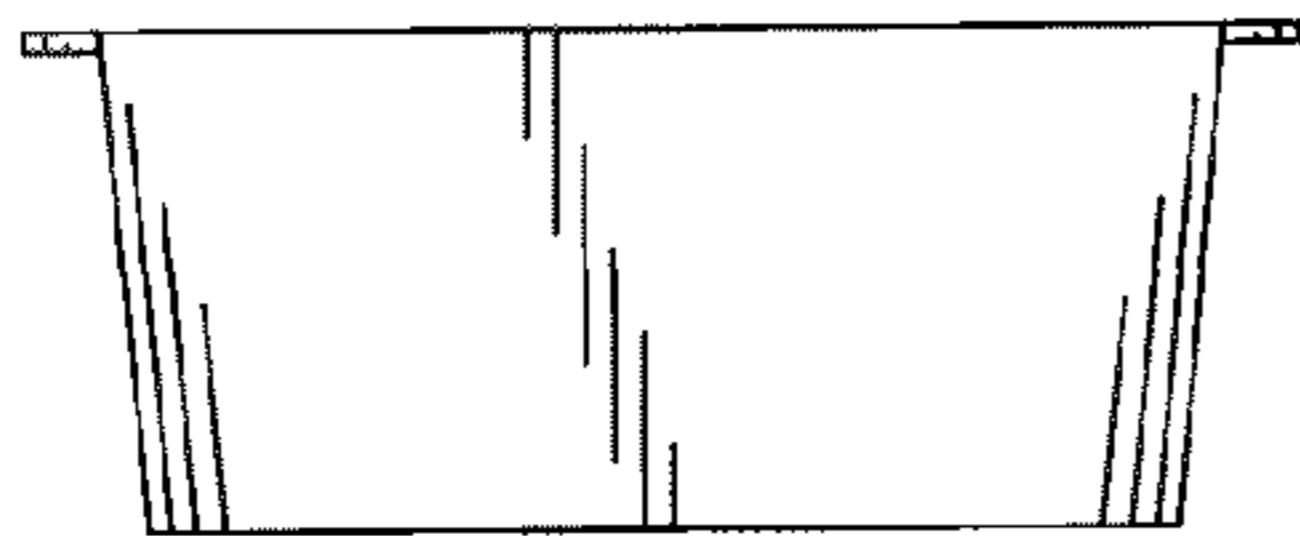

FIG. 8

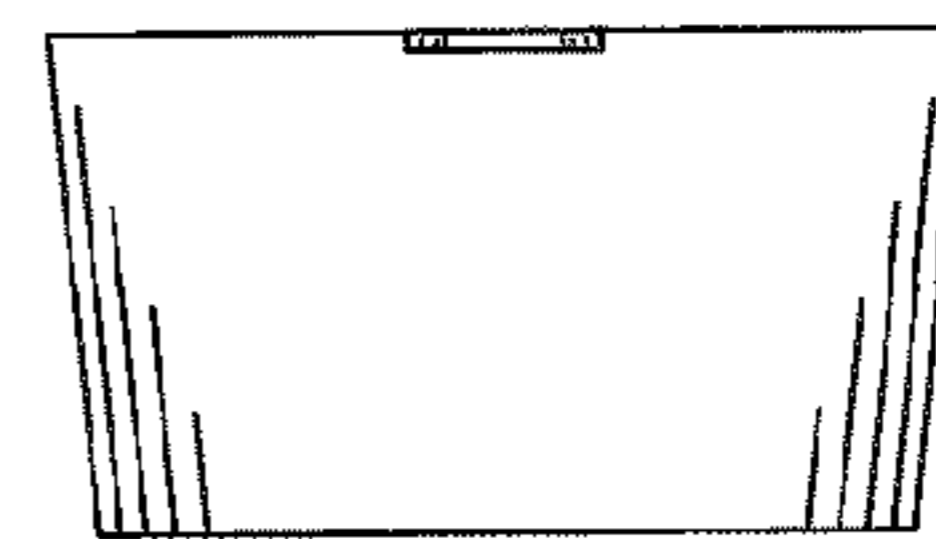

FIG. 9

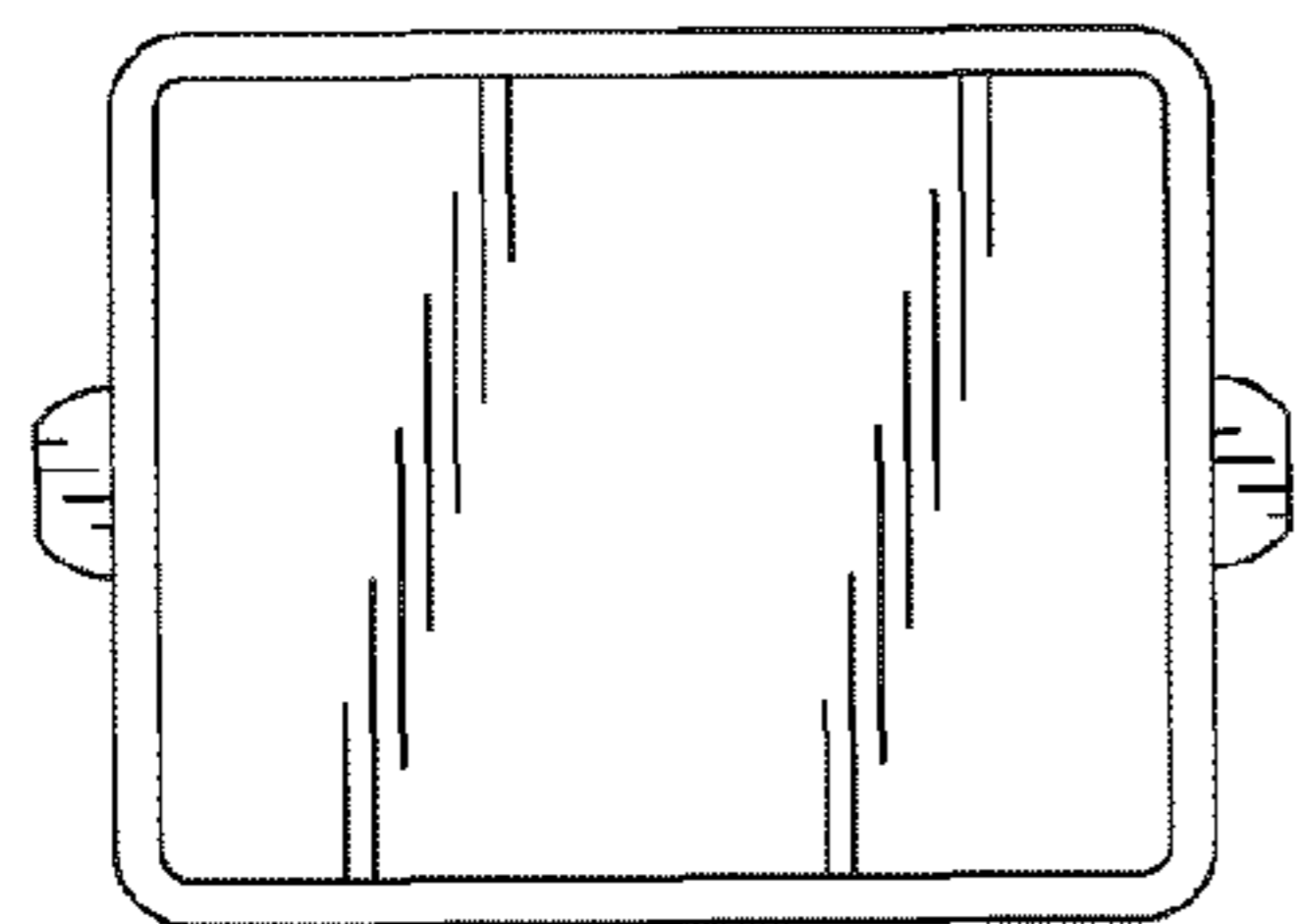

FIG. 10

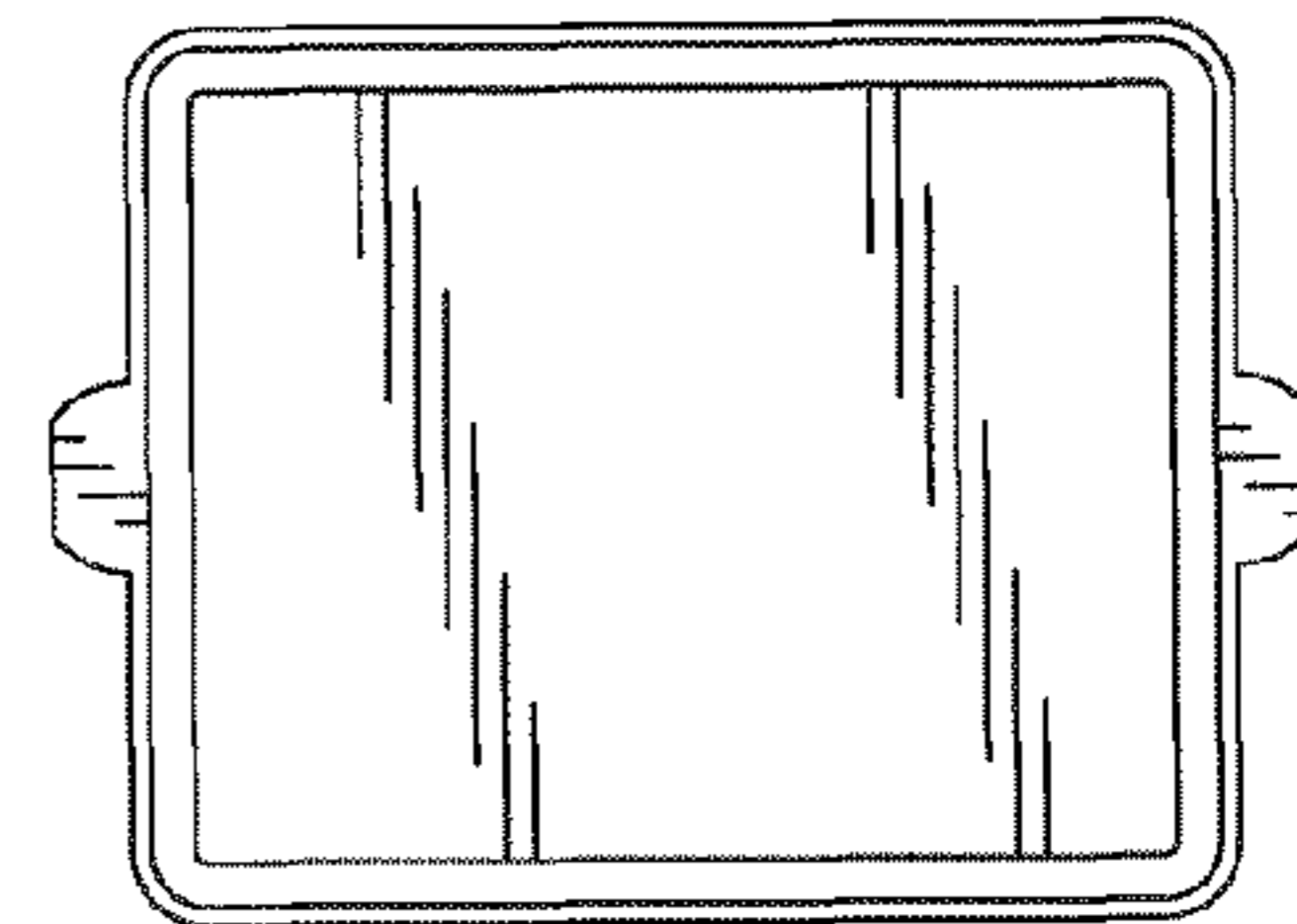

FIG. 11

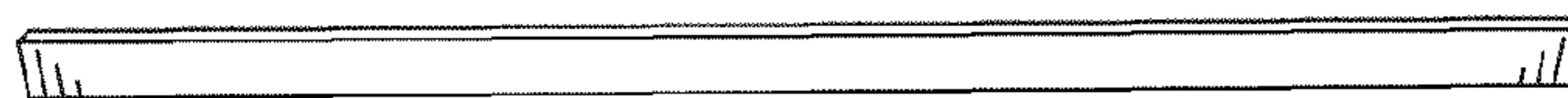

FIG. 12



FIG. 13

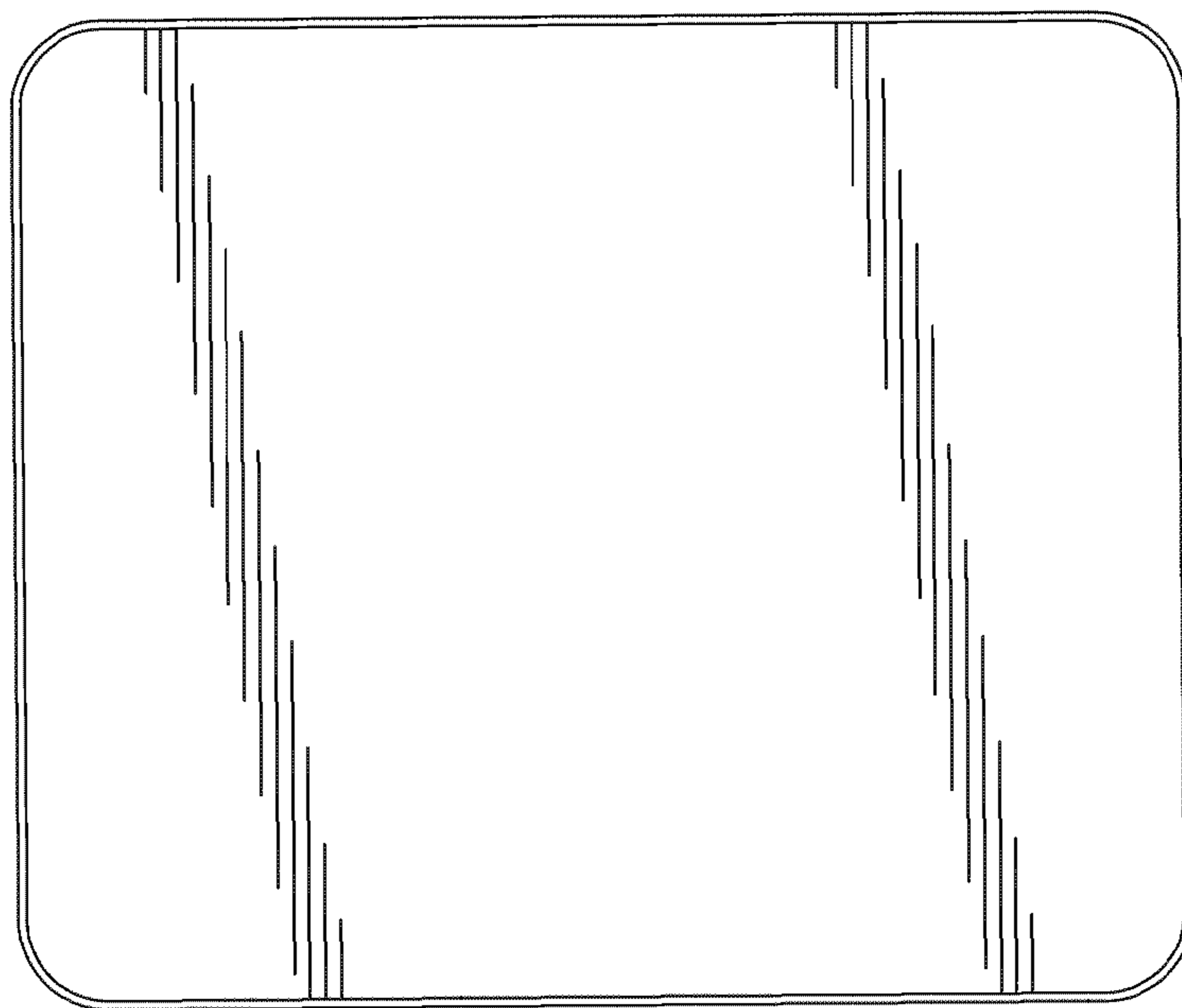

FIG. 14

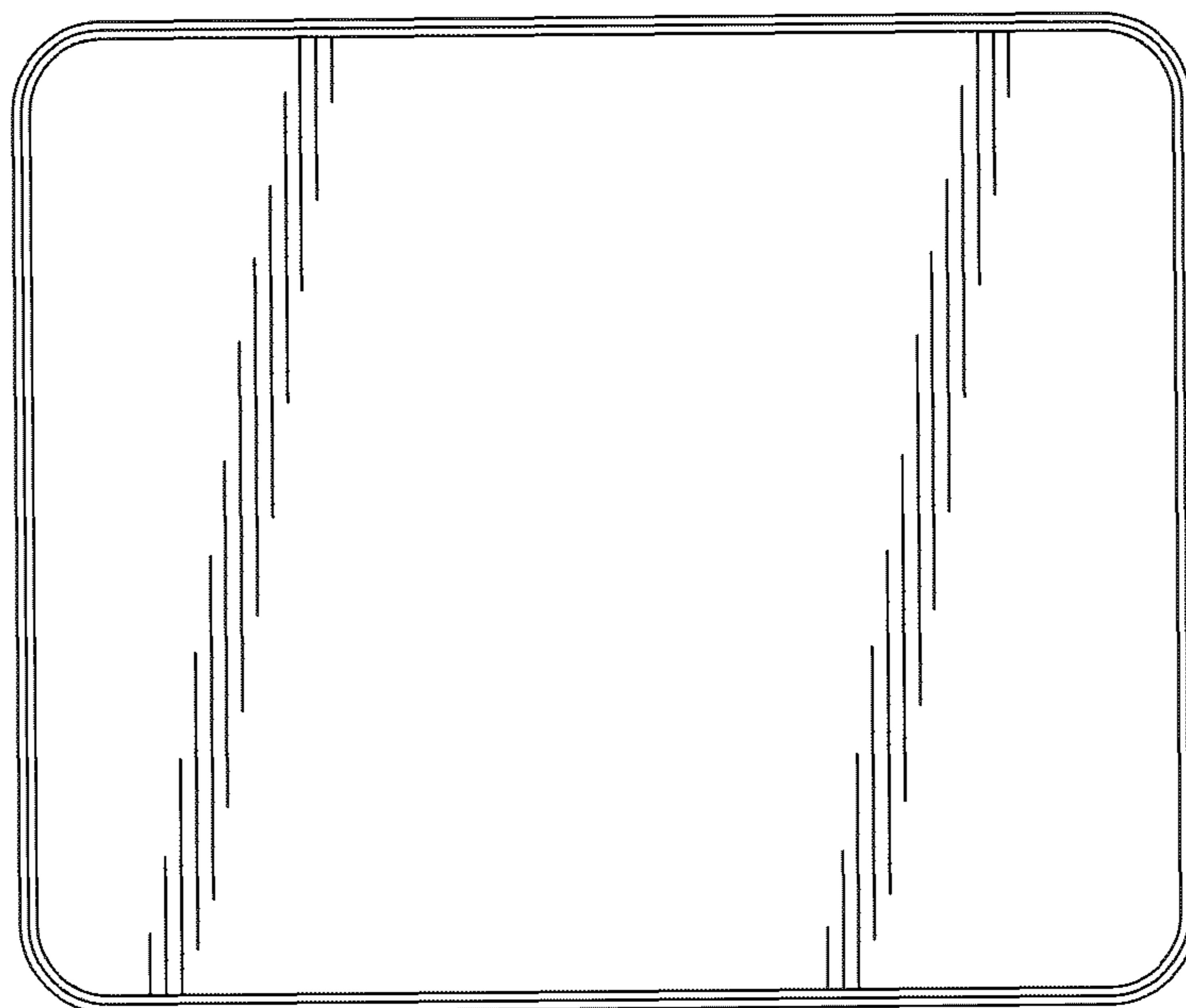

FIG. 15