



US00D615777S

(12) **United States Design Patent**  
**Lee et al.**

(10) **Patent No.:** **US D615,777 S**  
(45) **Date of Patent:** **\*\* May 18, 2010**

(54) **BASKET SHELF RACK**

(75) Inventors: **David Y Lee**, Bel Air, CA (US); **Younki Kho**, Los Angeles, CA (US)

(73) Assignee: **Enjoy Plastics USA, Inc.**, Vernon, CA (US)

(\*\*) Term: **14 Years**

(21) Appl. No.: **29/332,871**

(22) Filed: **Feb. 26, 2009**

(51) **LOC (9) Cl.** ..... **06-04**

(52) **U.S. Cl.** ..... **D6/479**

(58) **Field of Classification Search** ..... D6/462–465,  
D6/408, 467–468, 479, 474, 458; 211/133,  
211/181, 126, 189, 186; D7/409, 388  
See application file for complete search history.

(56) **References Cited**

**U.S. PATENT DOCUMENTS**

4,811,670	A	3/1989	Kolvites et al.	
D303,444	S *	9/1989	Yoshikawa	D34/21
D319,156	S *	8/1991	Cugley	D6/474
5,279,231	A	1/1994	Kolvites et al.	
5,384,103	A	1/1995	Miller	
5,423,251	A	6/1995	Kolvites et al.	
D369,037	S *	4/1996	Wyatt et al.	D6/465
5,709,158	A	1/1998	Wareheim	
D400,739	S *	11/1998	Sheng	D6/479
5,884,782	A	3/1999	Dembicks	
D411,045	S *	6/1999	Morandi	D34/21
D418,998	S *	1/2000	Glassenberg	D6/458
D424,836	S *	5/2000	Kopala, Jr.	D6/465
6,116,436	A	9/2000	Ferrucci et al.	
D436,239	S *	1/2001	Walsh	D34/21
D436,461	S *	1/2001	Walker	D6/432
6,244,447	B1	6/2001	Frieze et al.	
6,290,077	B2	9/2001	Sosso	
6,378,764	B1	4/2002	Teixidor Casanovas	
D460,848	S *	7/2002	Tzeng	D34/21

D471,033	S *	3/2003	Yamaguchi	D6/465
D471,381	S *	3/2003	Yamaguchi	D6/465
6,820,757	B2 *	11/2004	Craft et al.	211/188
D501,105	S *	1/2005	Post et al.	D6/510
7,066,342	B2	6/2006	Baechle et al.	
7,137,517	B2	11/2006	Lowry et al.	
D547,093	S *	7/2007	Butters	D6/462
D552,880	S *	10/2007	Okura et al.	D6/465
D567,553	S *	4/2008	Post et al.	D6/510
D580,193	S *	11/2008	Sparkowski	D6/463
D591,533	S *	5/2009	Karsson	D6/474
D591,535	S *	5/2009	Karsson	D6/484
2004/0089625	A1 *	5/2004	Tsai	211/126.2
2007/0034584	A1	2/2007	Park	

\* cited by examiner

*Primary Examiner*—Elizabeth A Albert  
*Assistant Examiner*—Kelley A Donnelly  
(74) *Attorney, Agent, or Firm*—Peter Ganjian

(57) **CLAIM**

The ornamental design for a basket shelf rack, as shown and described.

**DESCRIPTION**

The present Application is related to the pending U.S. Utility patent application Ser. No. 11/274,591, filed Nov. 16, 2005.

FIG. 1 is a right front perspective view of a first embodiment of a basket shelf rack showing our new design;

FIG. 2 is an exploded right front perspective view thereof;

FIG. 3 is a front view thereof;

FIG. 4 is a back view thereof;

FIG. 5 is a right side view thereof;

FIG. 6 is a left side view thereof; and,

FIG. 7 is a top view thereof.

The broken lines are for environmental purposes only and form no part of the claimed design.

**1 Claim, 7 Drawing Sheets**

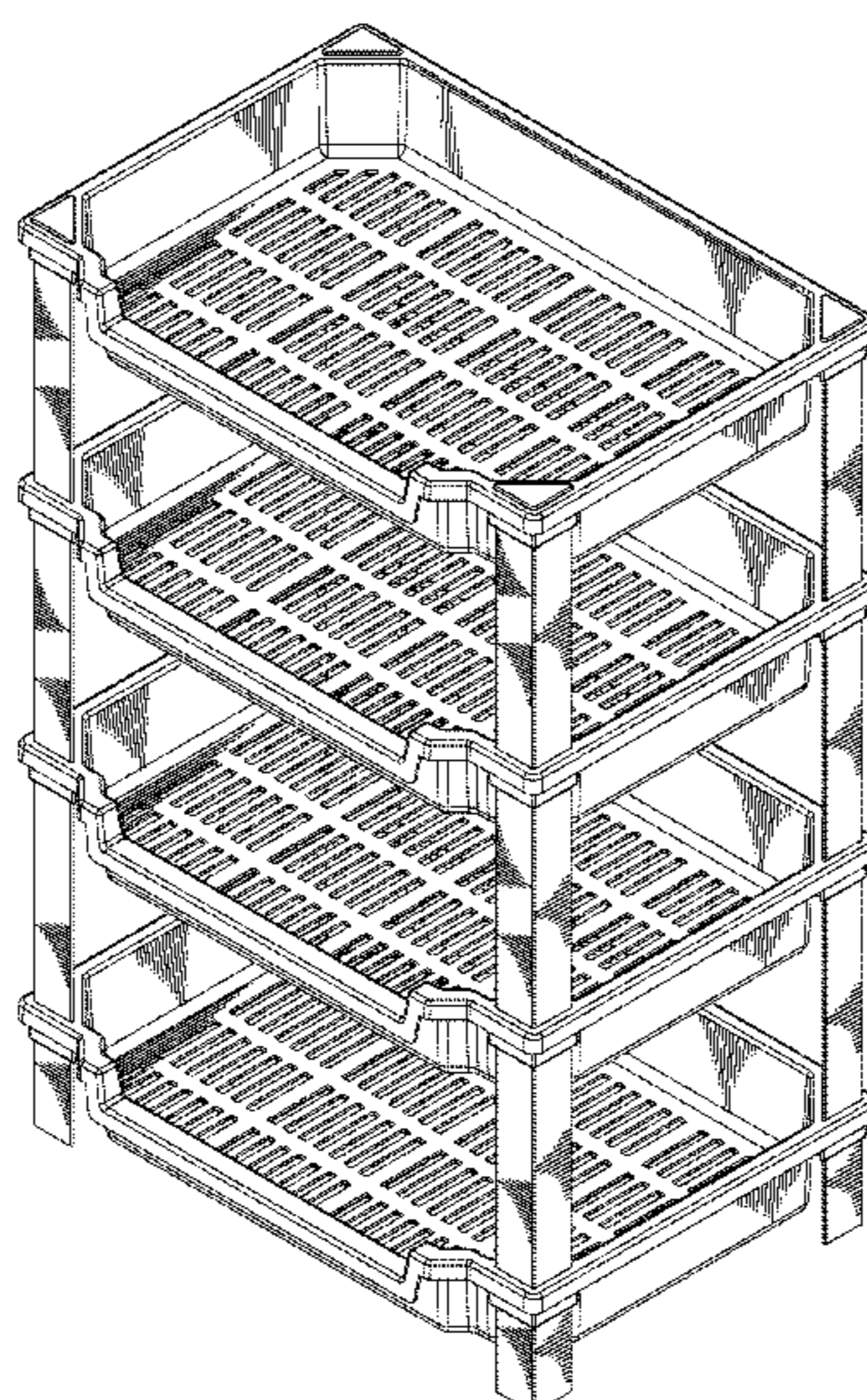

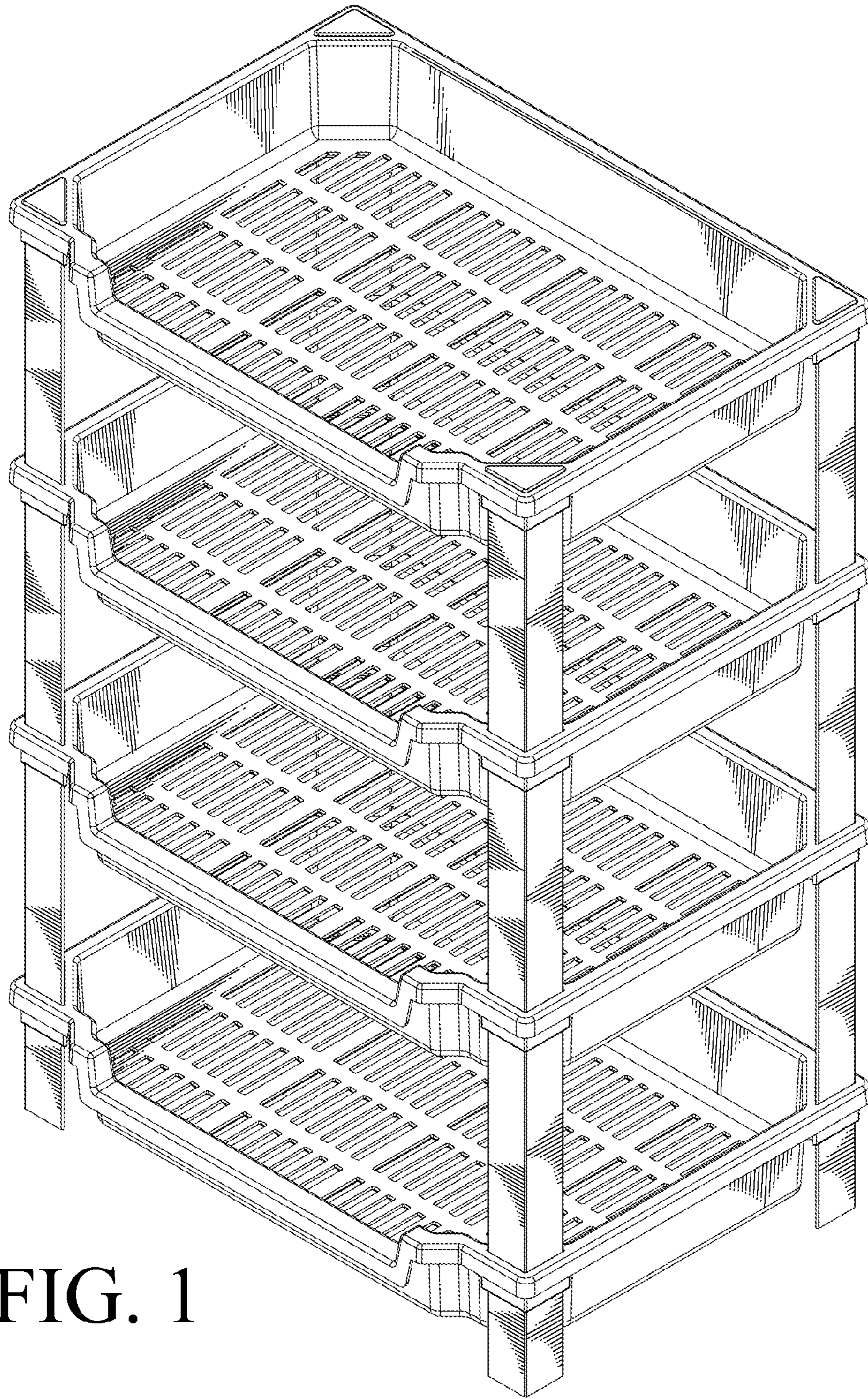
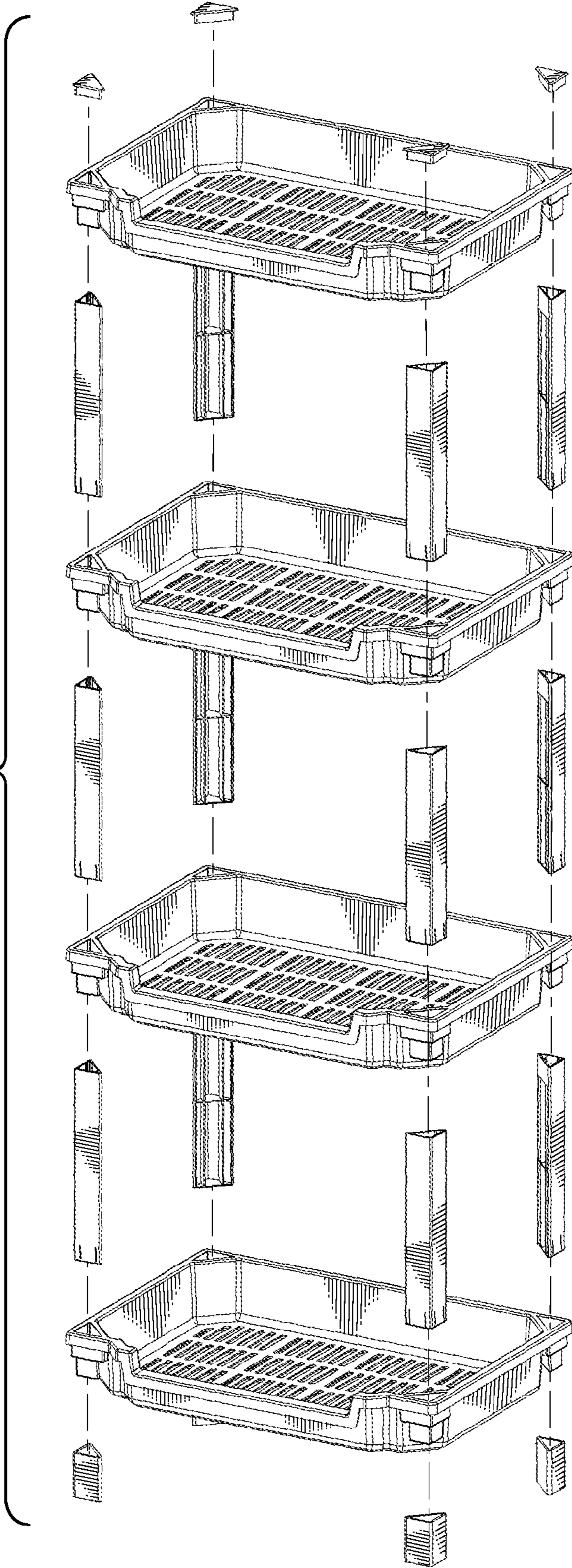

FIG. 1

FIG. 2



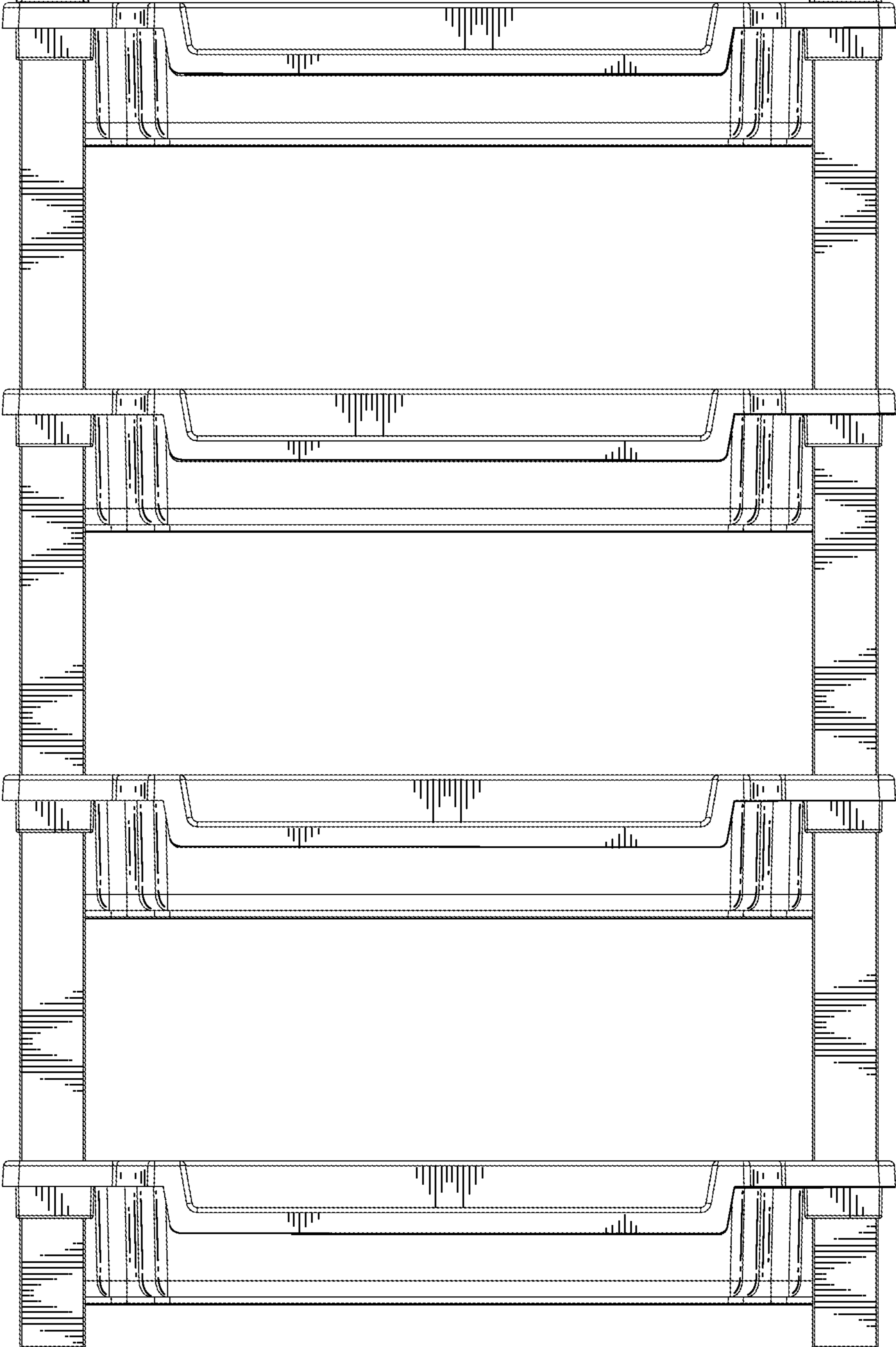

FIG. 3

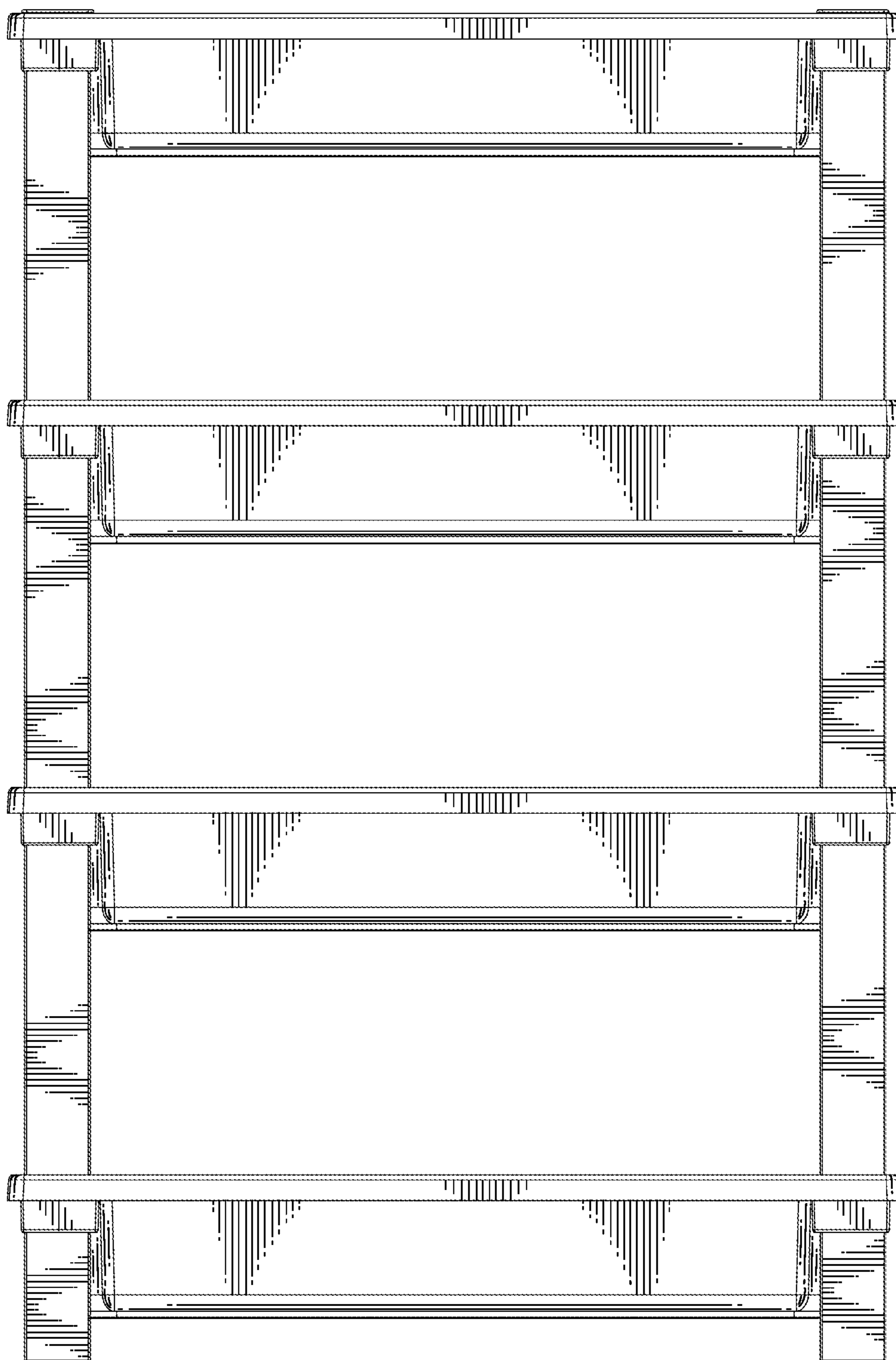

FIG. 4

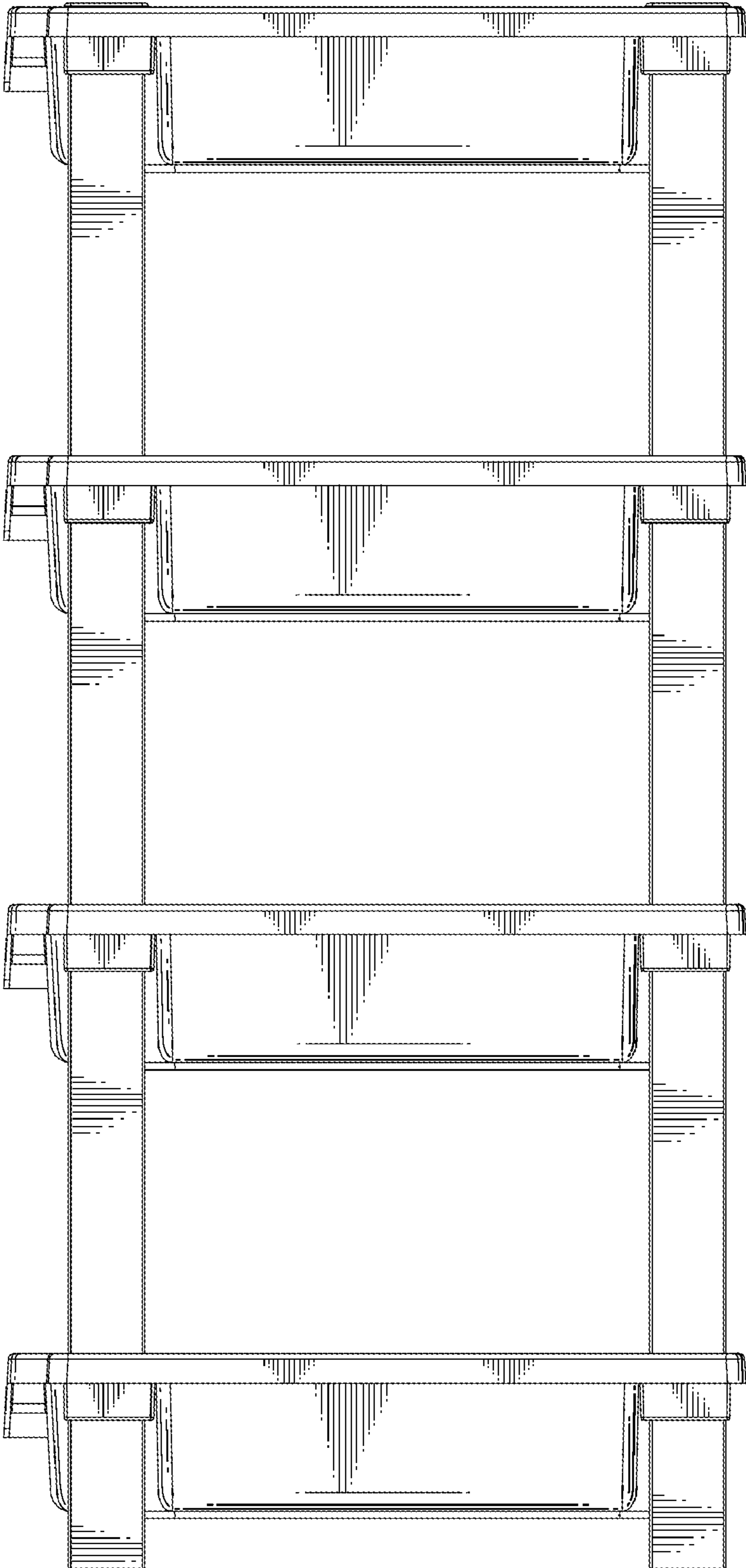

FIG. 5

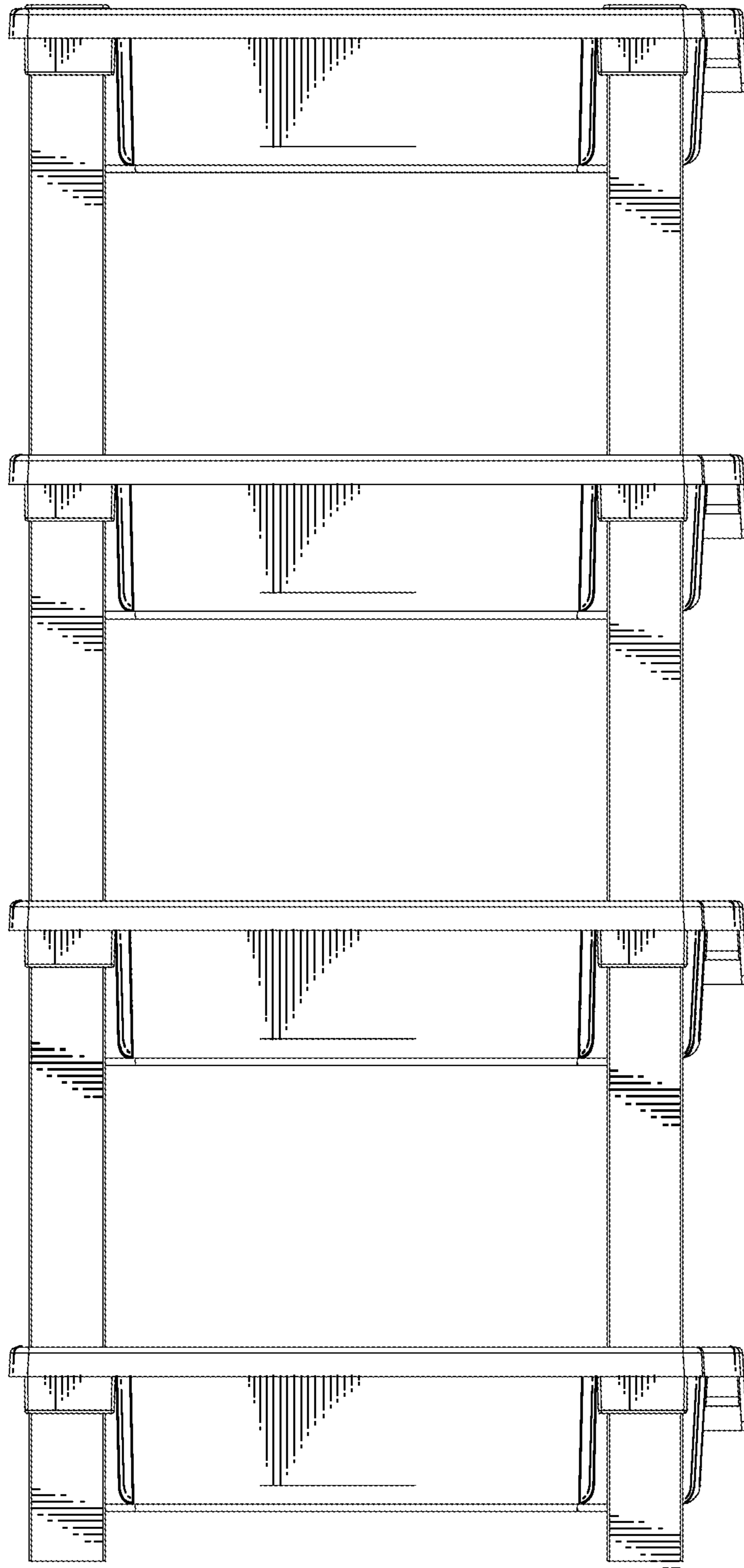

FIG. 6

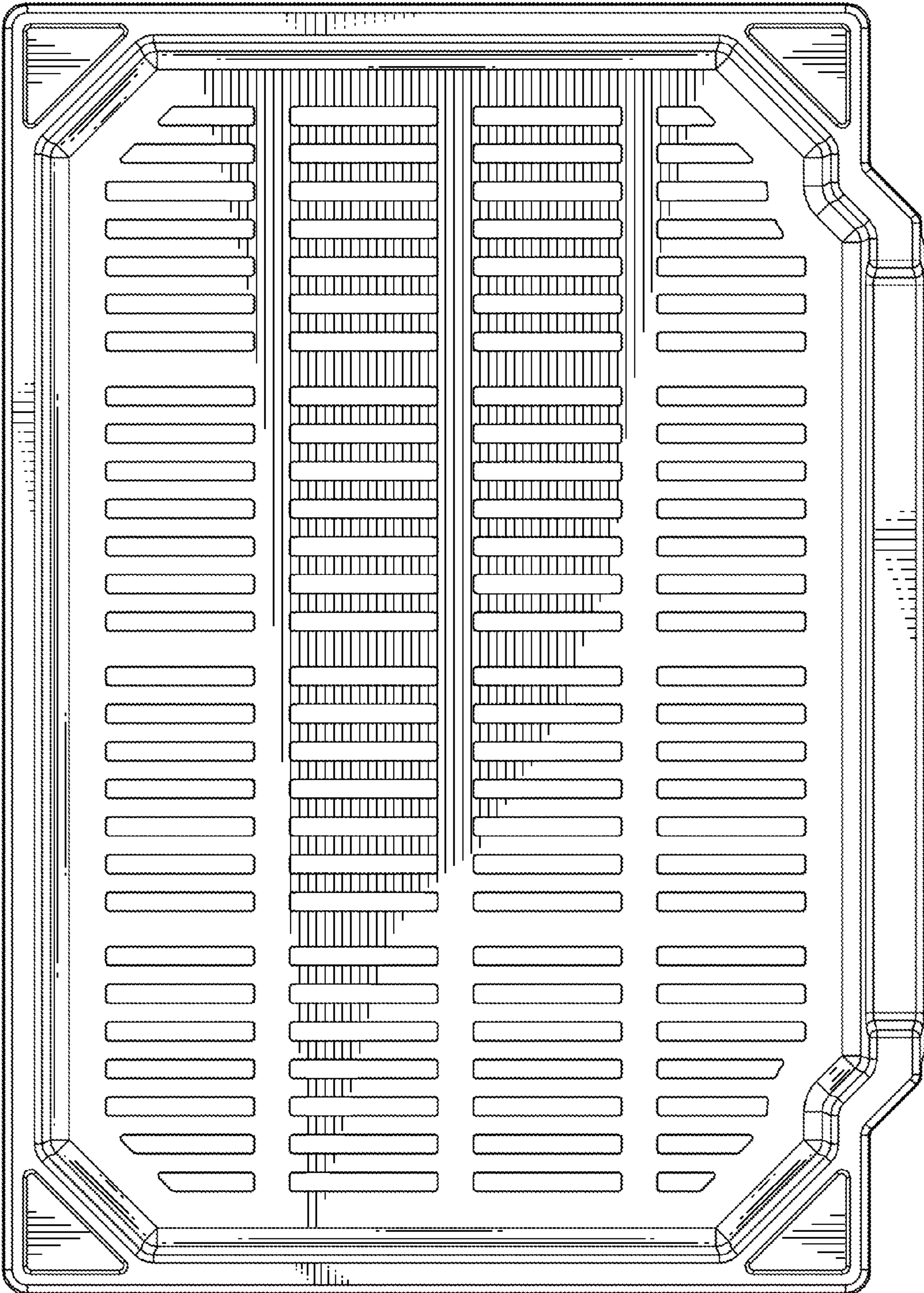

Fig. 7