



US00D615751S

(12) **United States Design Patent**
Avery

(10) **Patent No.:** **US D615,751 S**
(45) **Date of Patent:** **** May 18, 2010**

(54) **WAIST-CAN**

DESCRIPTION

(76) Inventor: **Devon Avery**, Whittaker Law Firm, 8
Greenway Plaza, Suit 606, Houston, TX
(US) 77046

(**) Term: **14 Years**

(21) Appl. No.: **29/339,312**

(22) Filed: **Jun. 28, 2009**

(51) **LOC (9) Cl.** **03-01**

(52) **U.S. Cl.** **D3/215**

(58) **Field of Classification Search** D3/215,
D3/228-229, 315; D30/161, 162; 119/858;
248/311.2, 146; D32/53, 53.1, 54; D25/68;
294/1.3; D6/566; 211/41.2

See application file for complete search history.

(56) **References Cited**

U.S. PATENT DOCUMENTS

5,713,616	A *	2/1998	Knudson	294/1.3
5,718,192	A *	2/1998	Sebastian	119/795
5,855,186	A *	1/1999	Larsen et al.	294/1.3
6,129,096	A *	10/2000	Johnson	294/1.3
D434,194	S *	11/2000	Bergquist	D30/152
D464,484	S *	10/2002	Landen	D3/229
D586,114	S *	2/2009	Ferguson	D3/228
D586,969	S *	2/2009	Graham	D32/54

* cited by examiner

Primary Examiner—Catherine R Oliver

(74) *Attorney, Agent, or Firm*—Whittaker Law Firm;
Malcolm E. Whittaker

(57) **CLAIM**

The ornamental design for the waist-can, as shown and described.

FIG. 1 is a perspective view of the preferred embodiment.
 FIG. 2 is a left side view of the preferred embodiment.
 FIG. 3 is a front view of the preferred embodiment.
 FIG. 4 is a right side view of the preferred embodiment.
 FIG. 5 is a rear view of the preferred embodiment.
 FIG. 6 is a top plan view of the preferred embodiment.
 FIG. 7 is a bottom plan view of the preferred embodiment.
 FIG. 8 is a perspective view of an alternative embodiment.
 FIG. 9 is a left view of an alternative embodiment.
 FIG. 10 is a front view of an alternative embodiment.
 FIG. 11 is a right view of an alternative embodiment.
 FIG. 12 is a rear view of an alternative embodiment.
 FIG. 13 is a top plan view of an alternative embodiment.
 FIG. 14 is a bottom plan view of an alternative embodiment.
 FIG. 15 is a perspective view of a second alternative embodiment.
 FIG. 16 is a left view of a second alternative embodiment.
 FIG. 17 is a front view a second alternative embodiment.
 FIG. 18 is a right view of a second alternative embodiment.
 FIG. 19 is a rear view of a second alternative embodiment.
 FIG. 20 is a top plan view of a second alternative embodiment.
 FIG. 21 is a bottom plan view of a second alternative embodiment; and,
 FIG. 22 is an environmental of the preferred embodiment.
 The broken line showing of environment in the drawings is included for the purpose of illustrating only and forms no part of the claimed design.

1 Claim, 22 Drawing Sheets



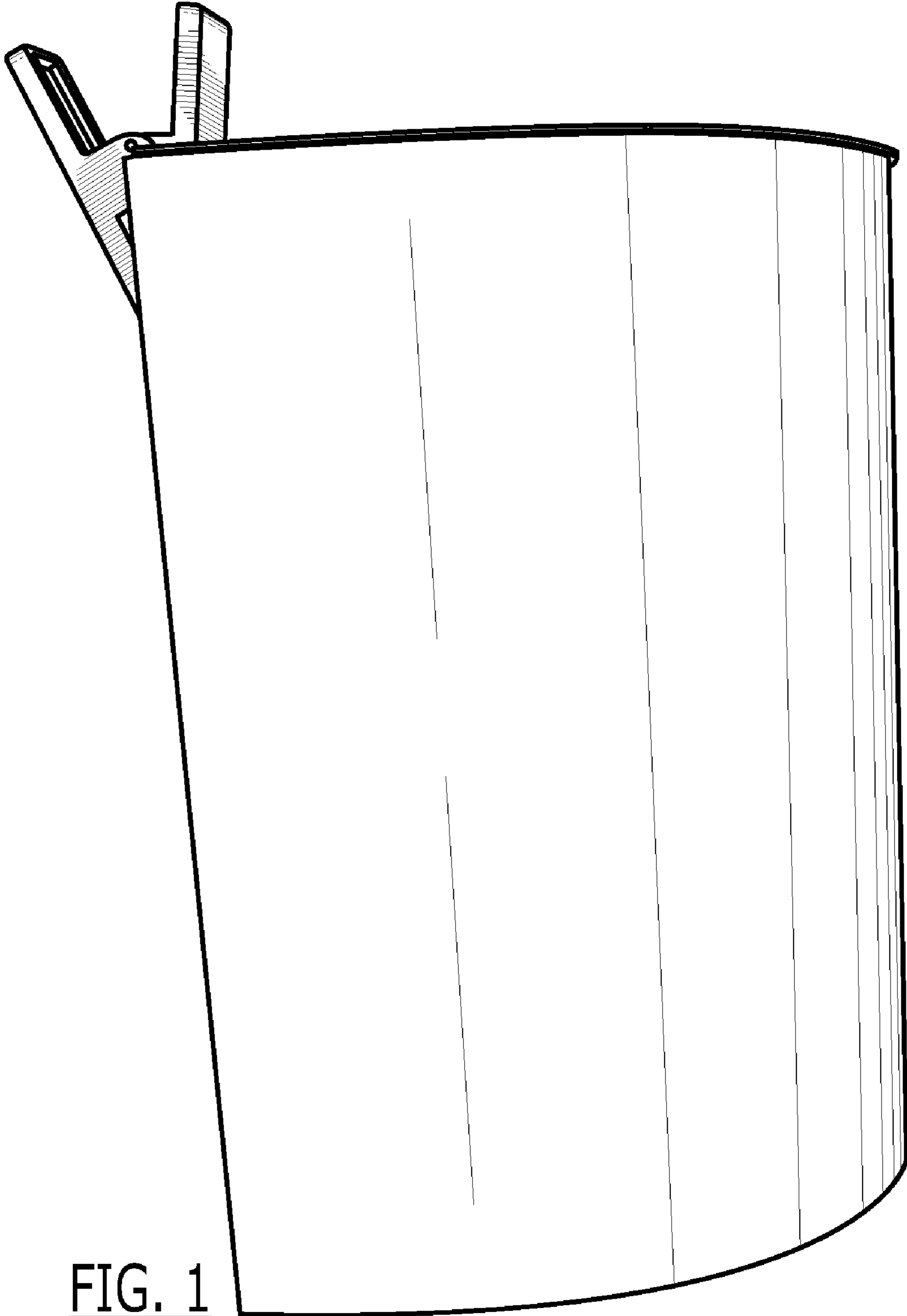

FIG. 1

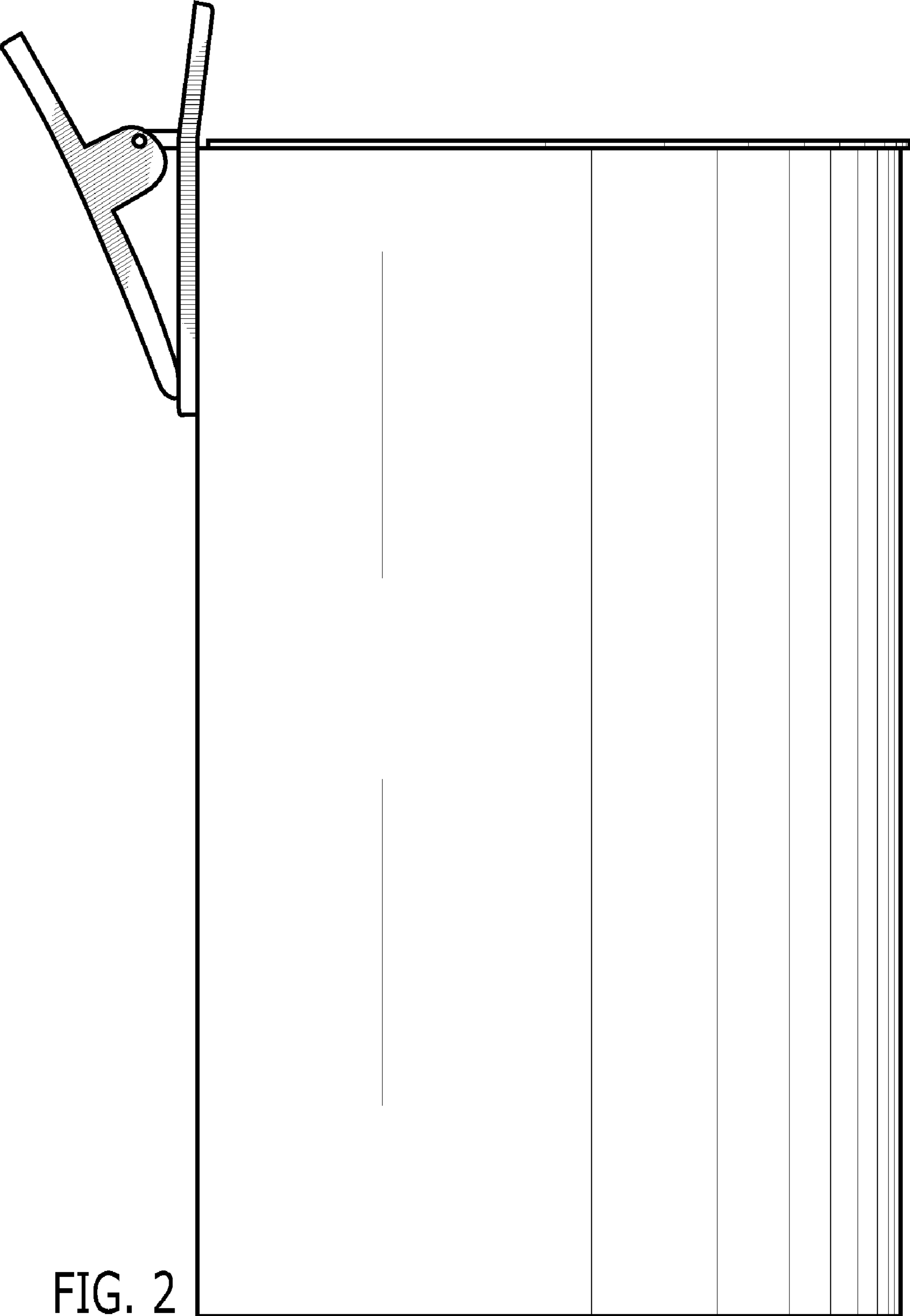

FIG. 2

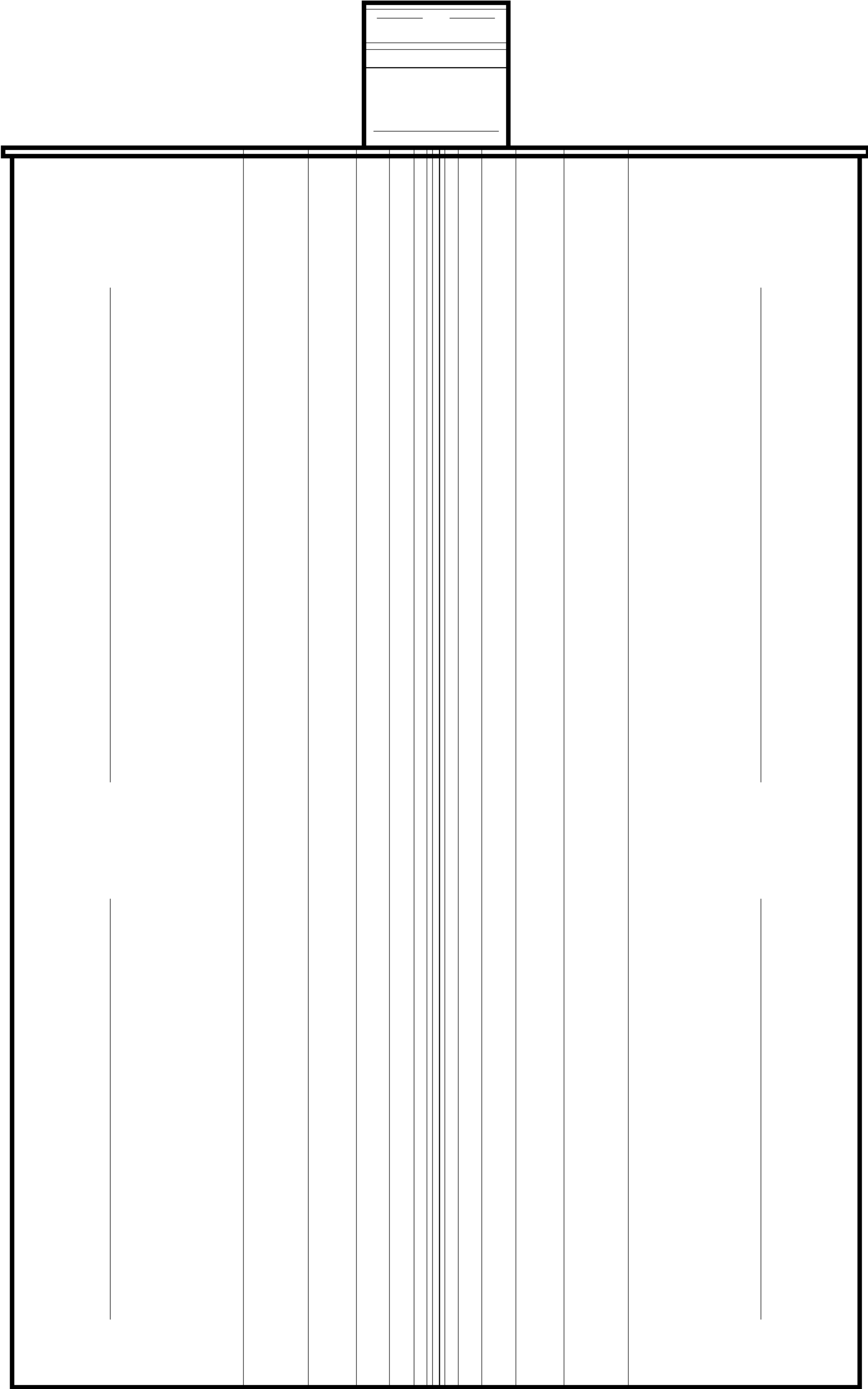

FIG. 3

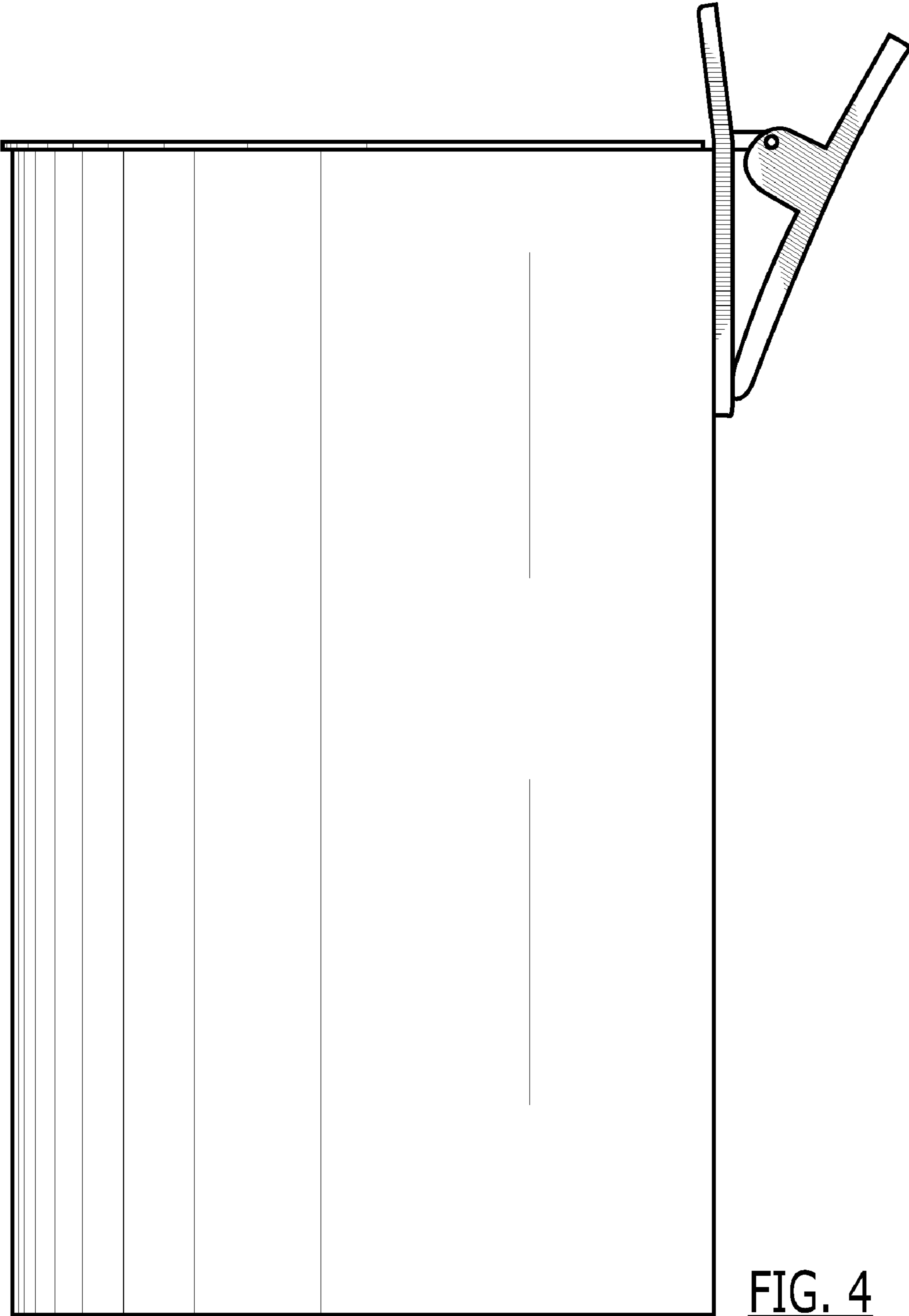

FIG. 4

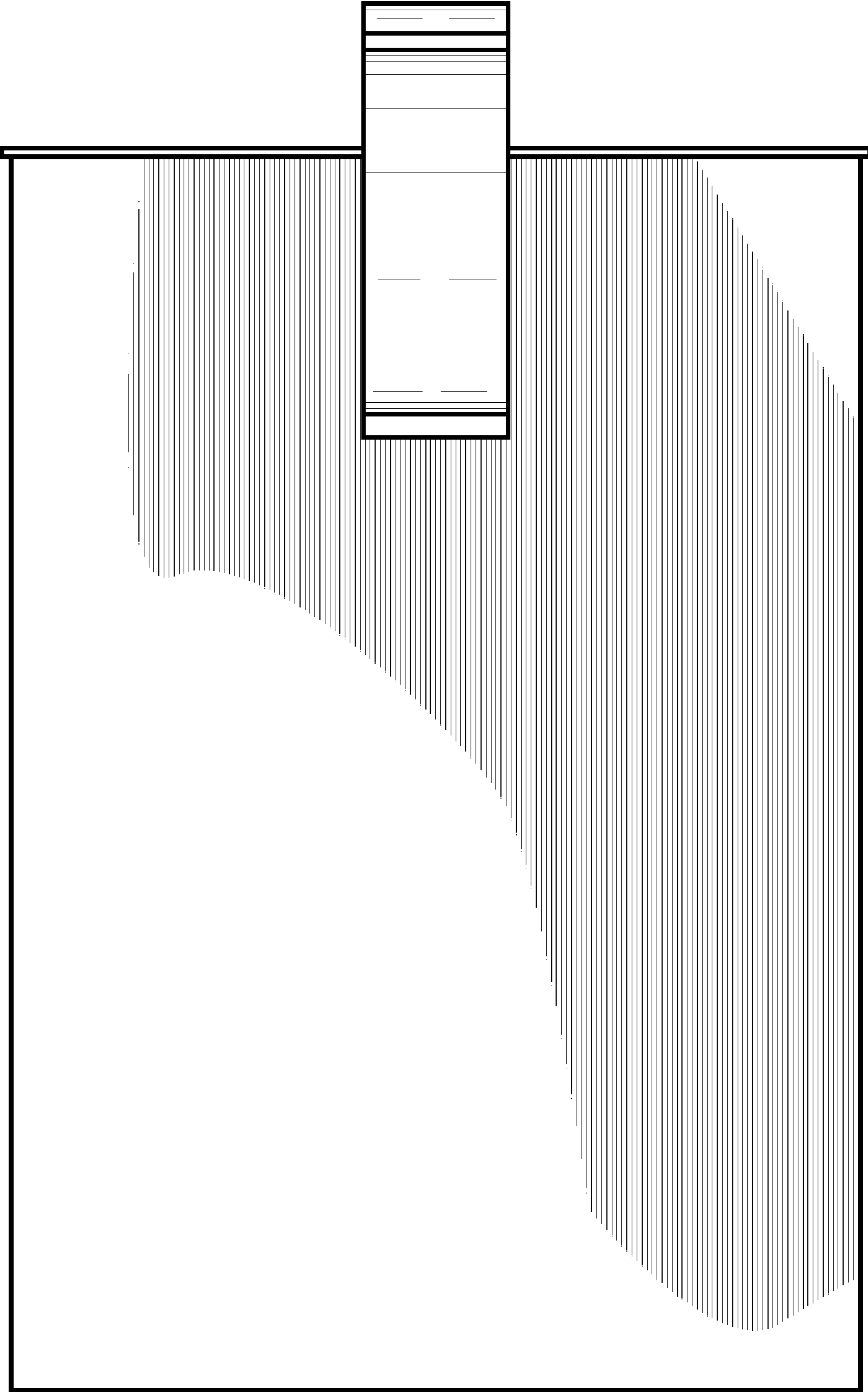

FIG. 5

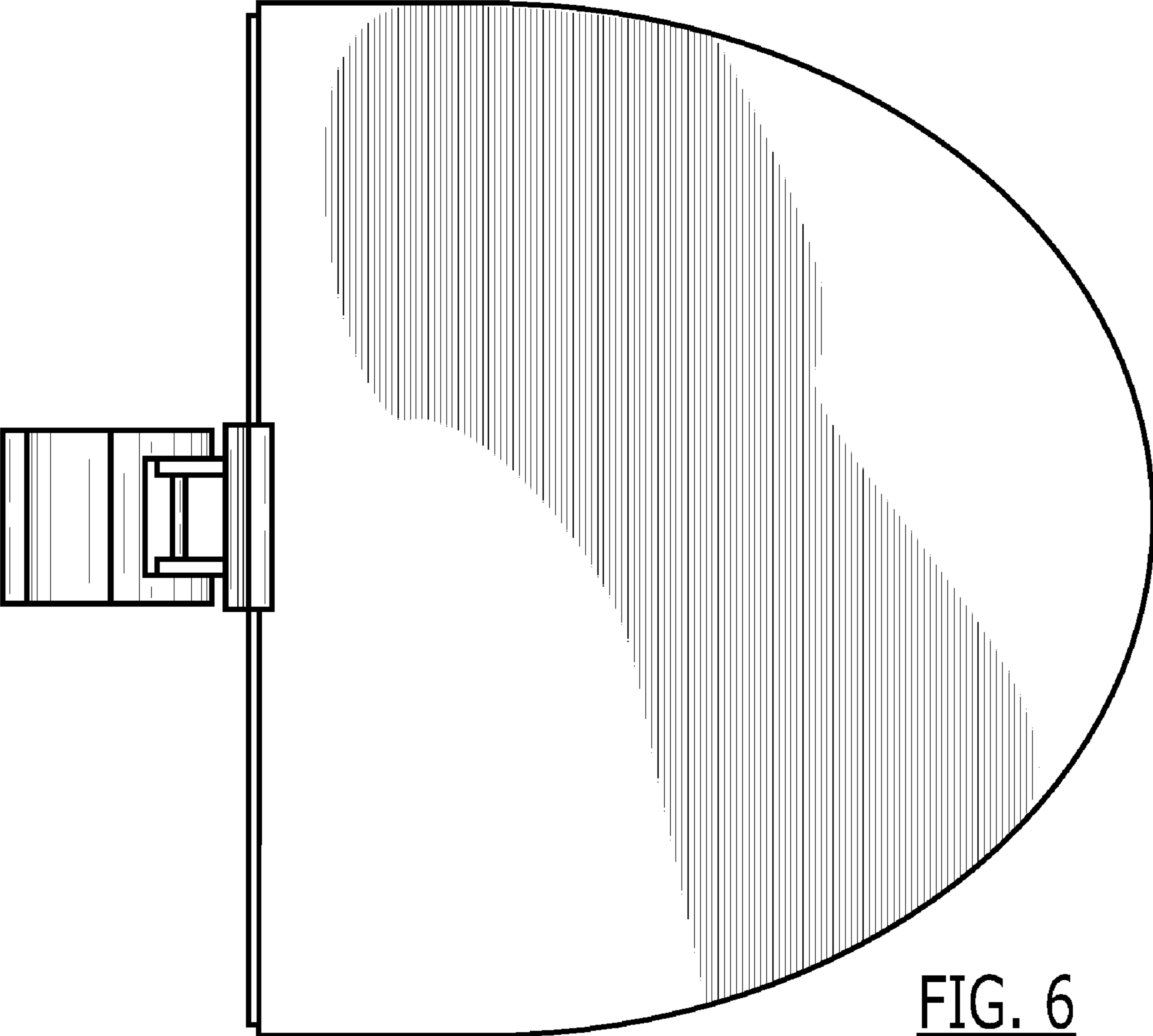
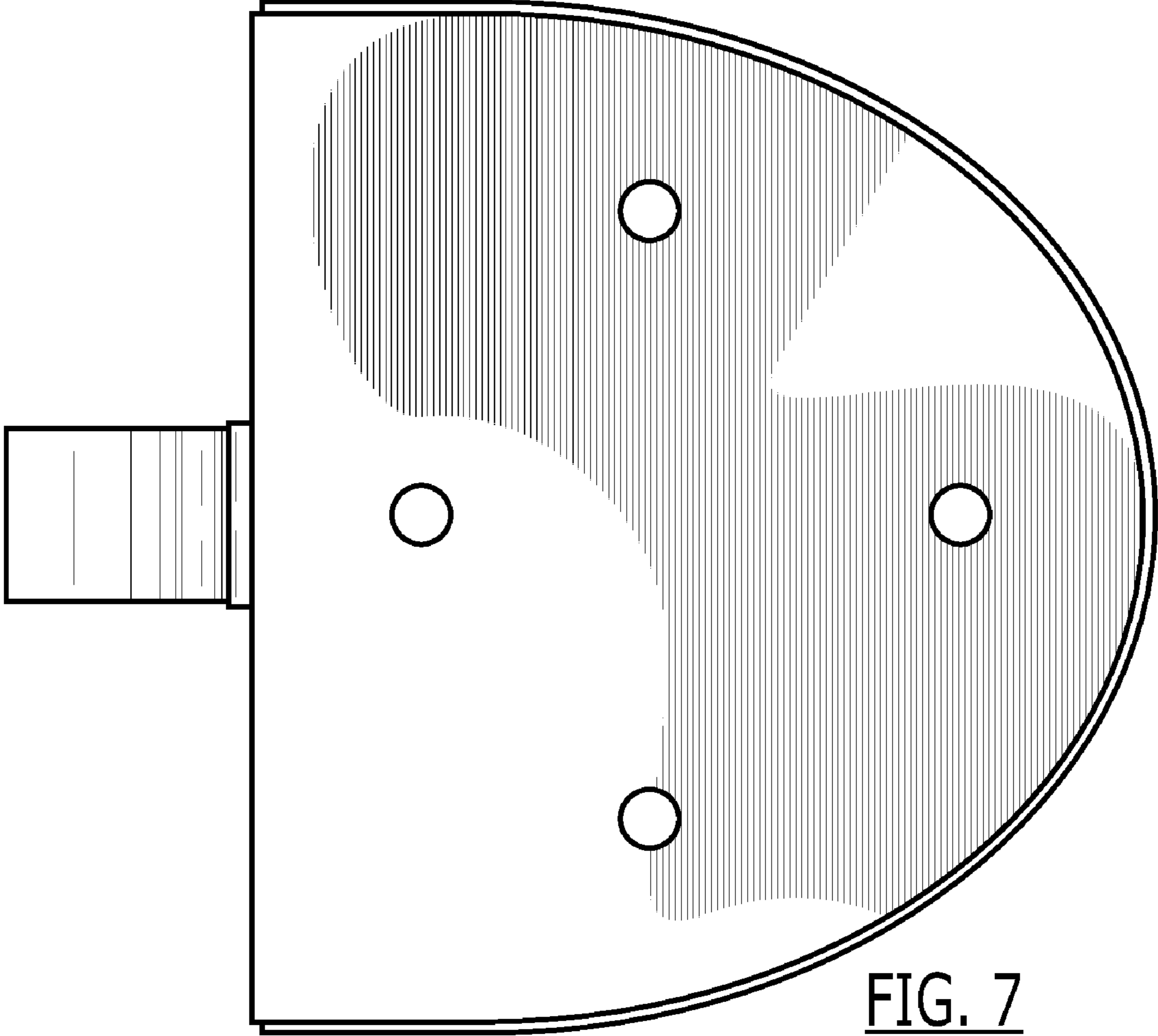

FIG. 6



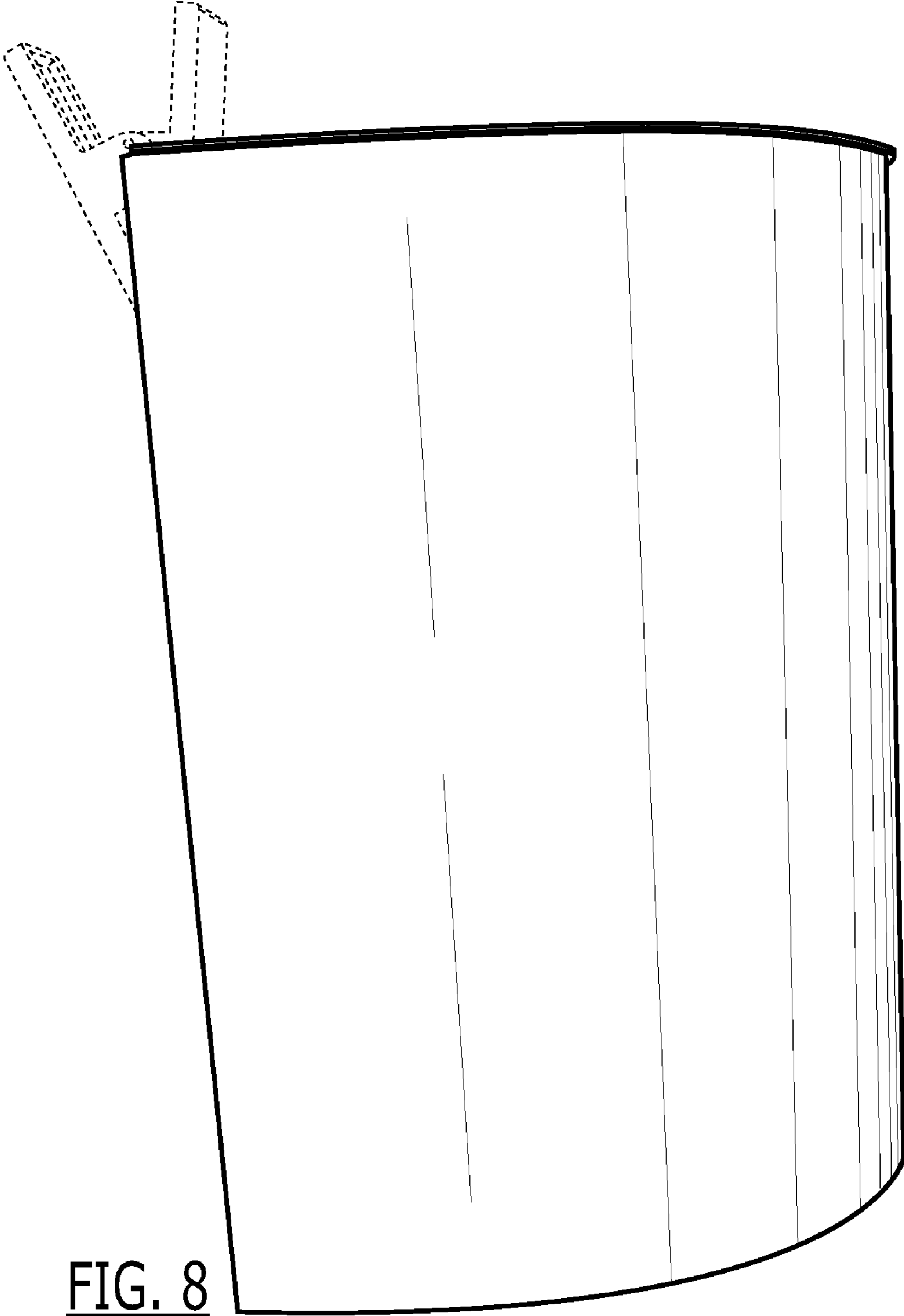

FIG. 8

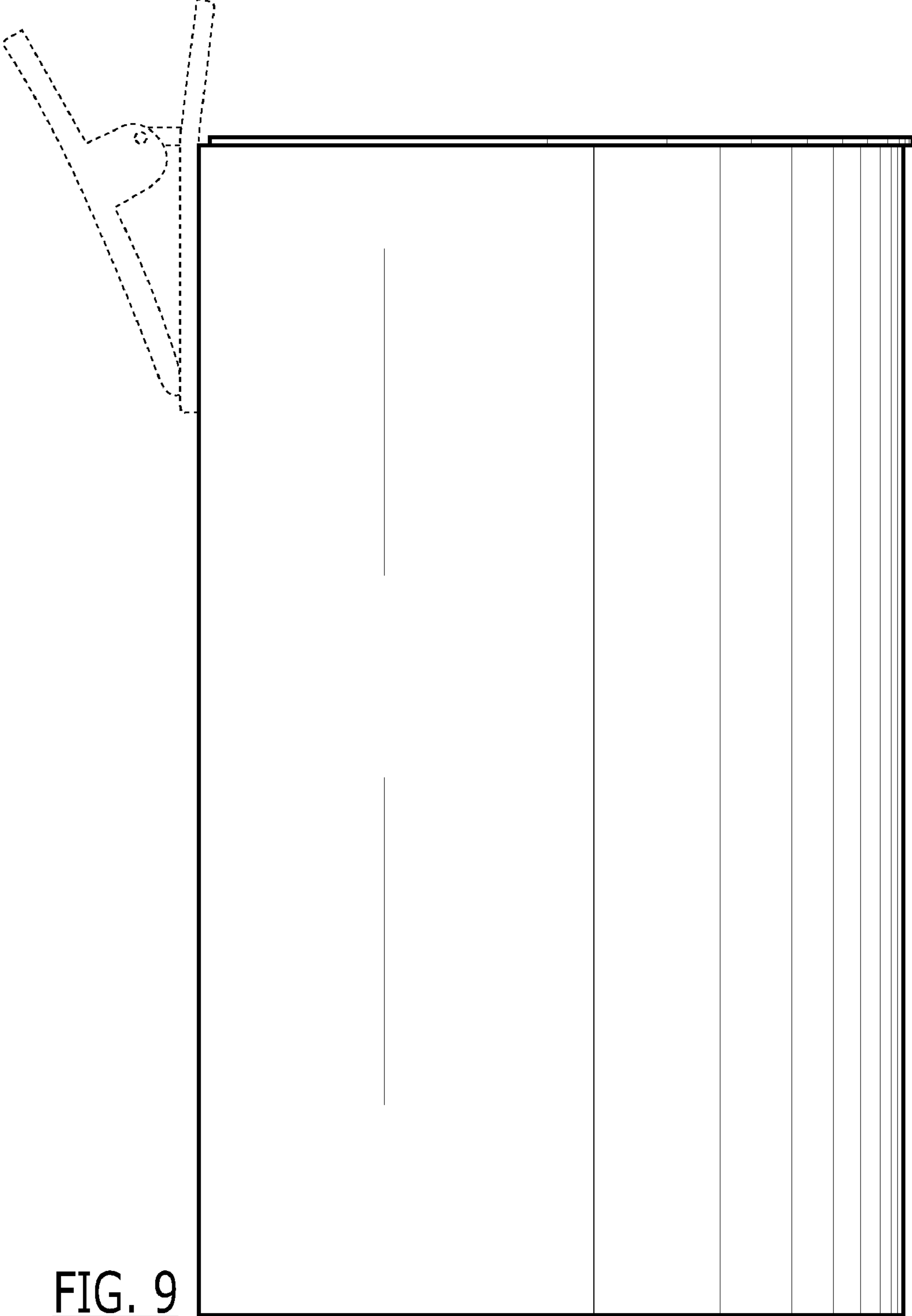

FIG. 9

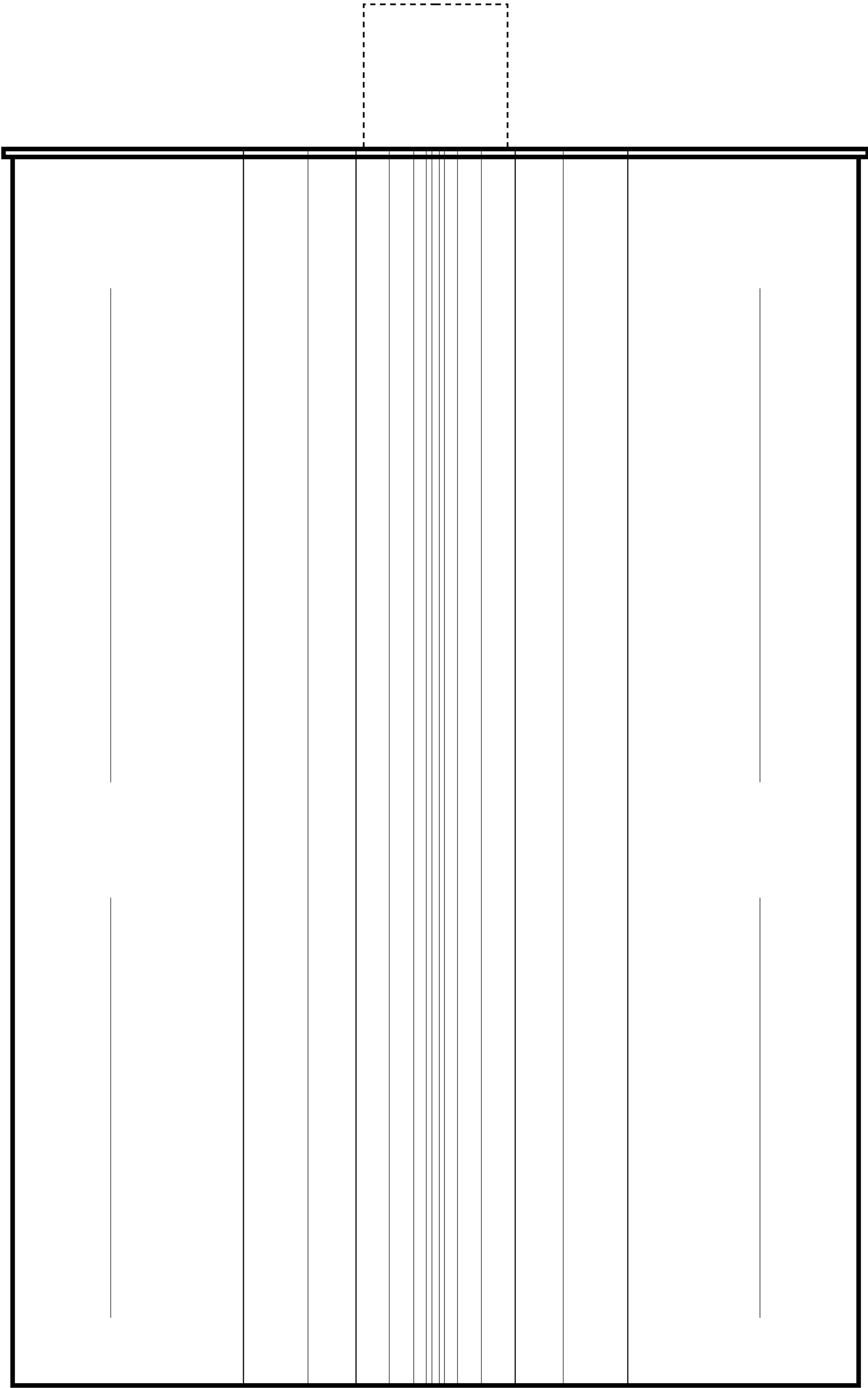

FIG. 10

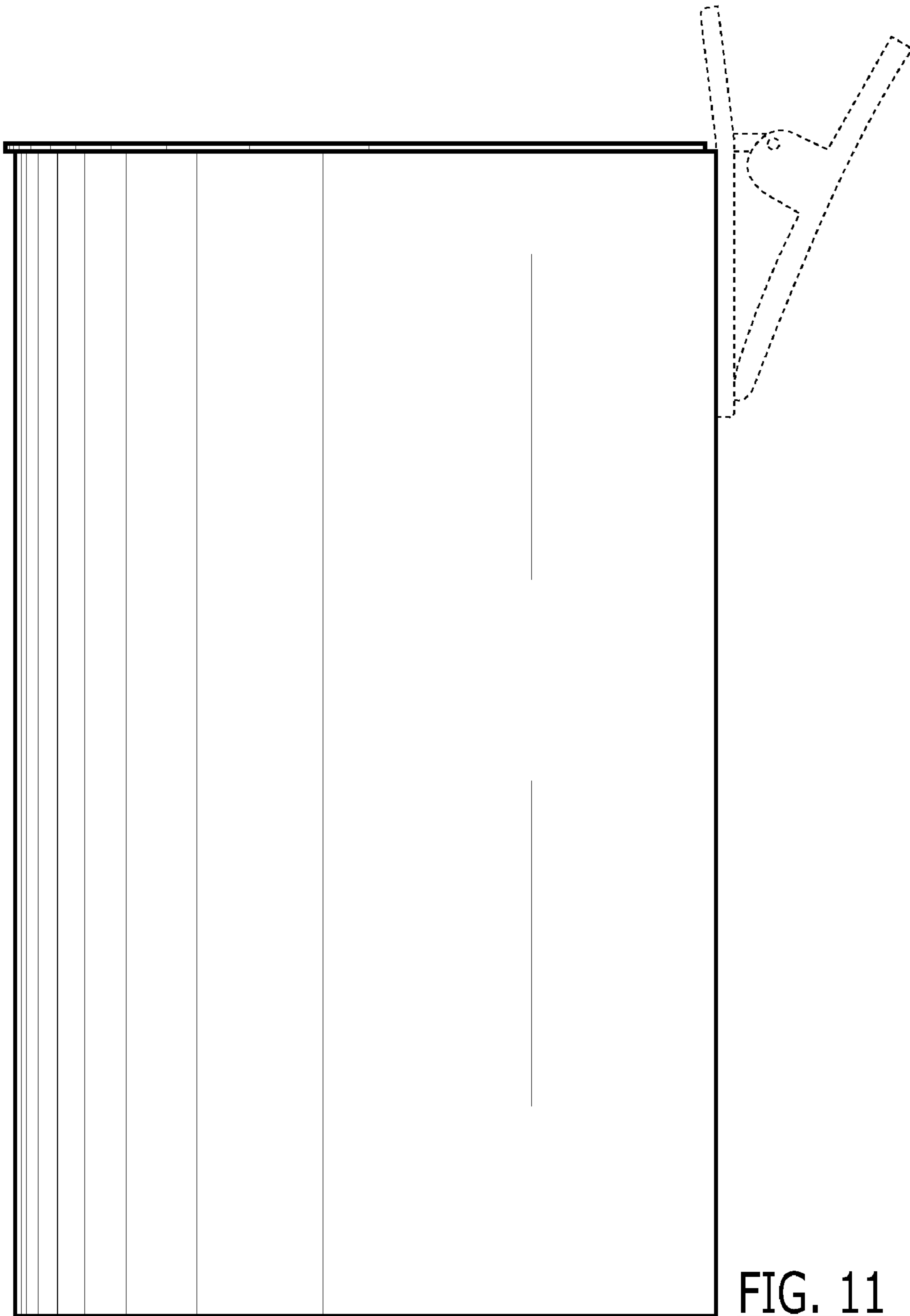

FIG. 11

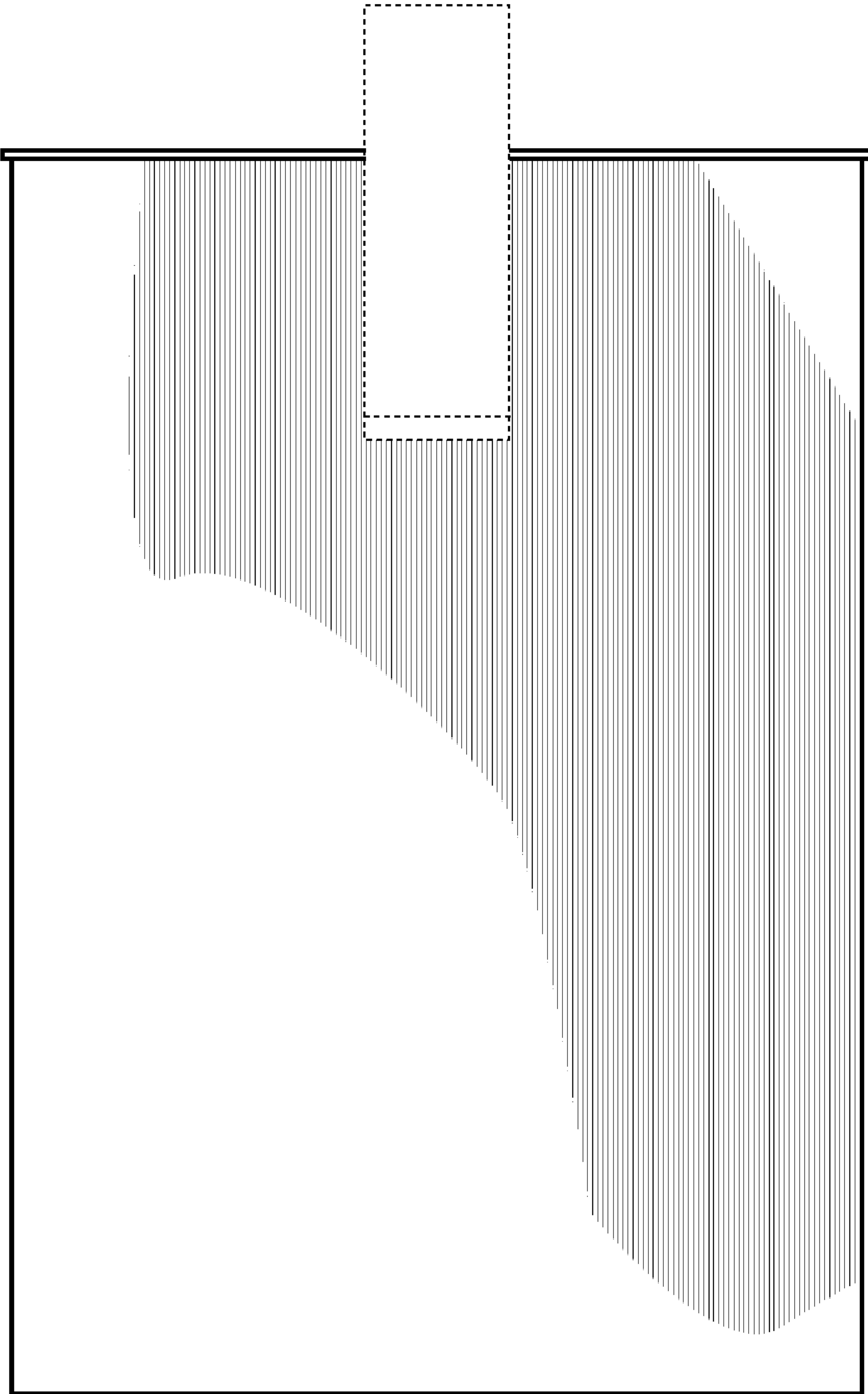
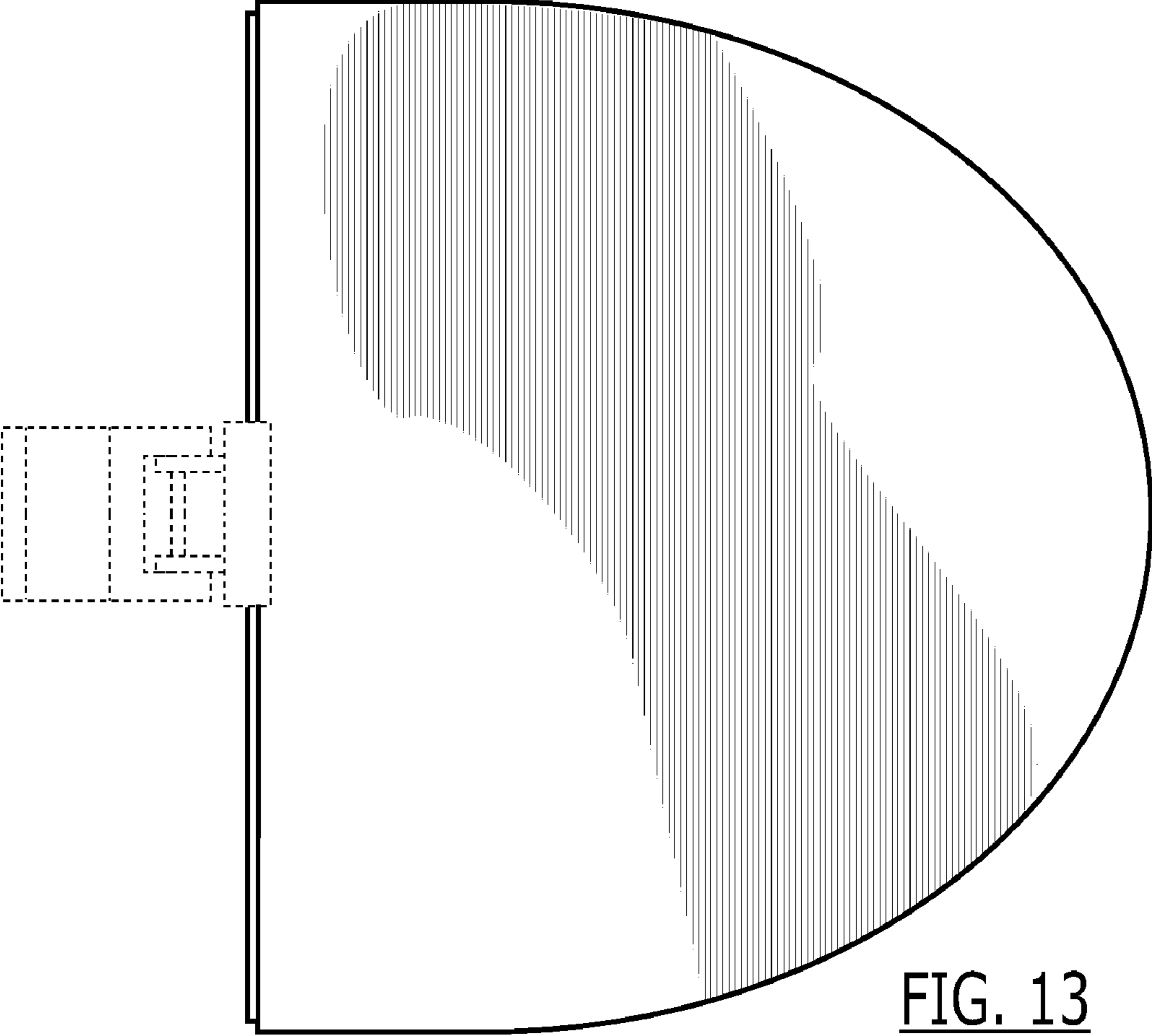
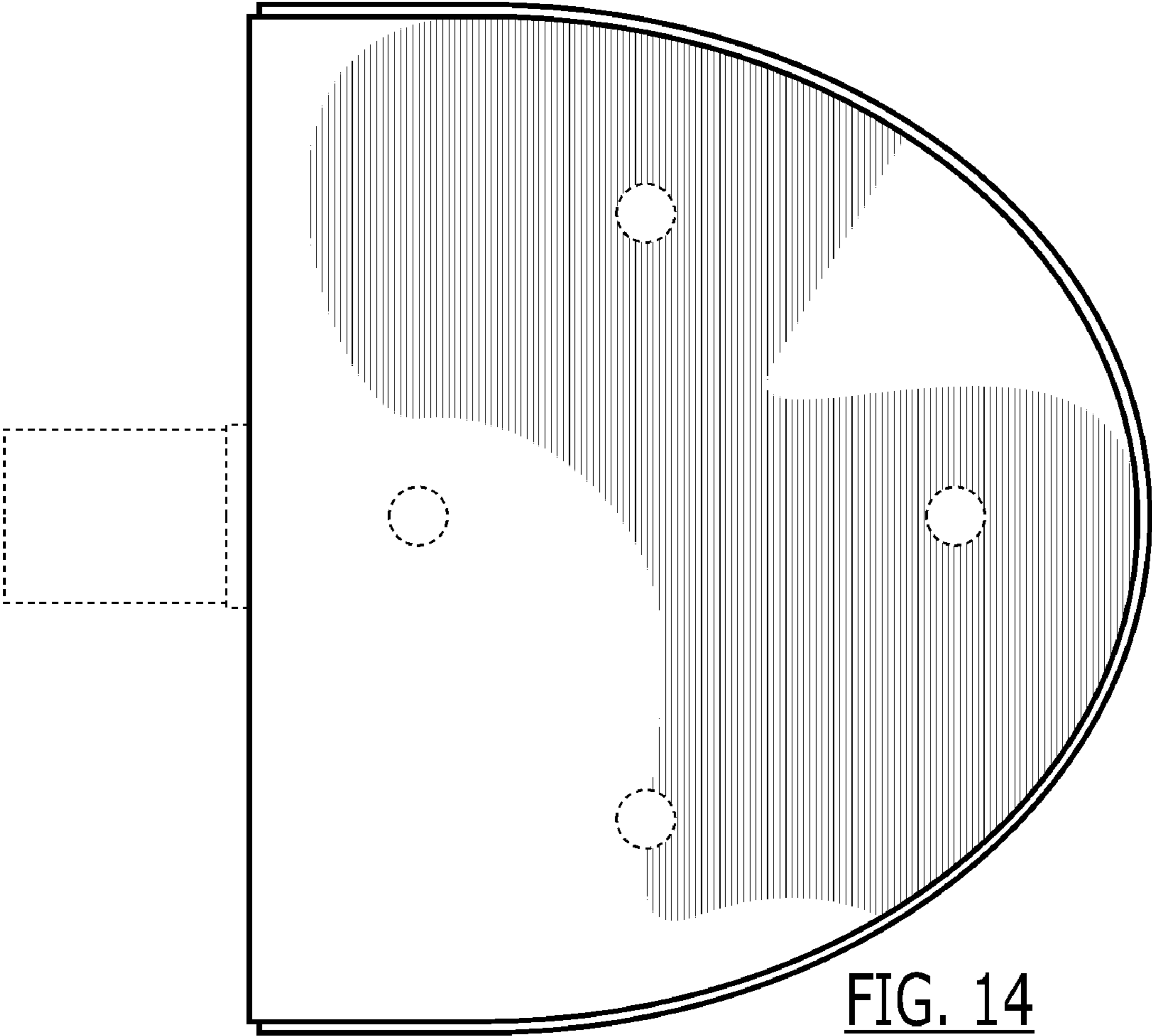

FIG. 12





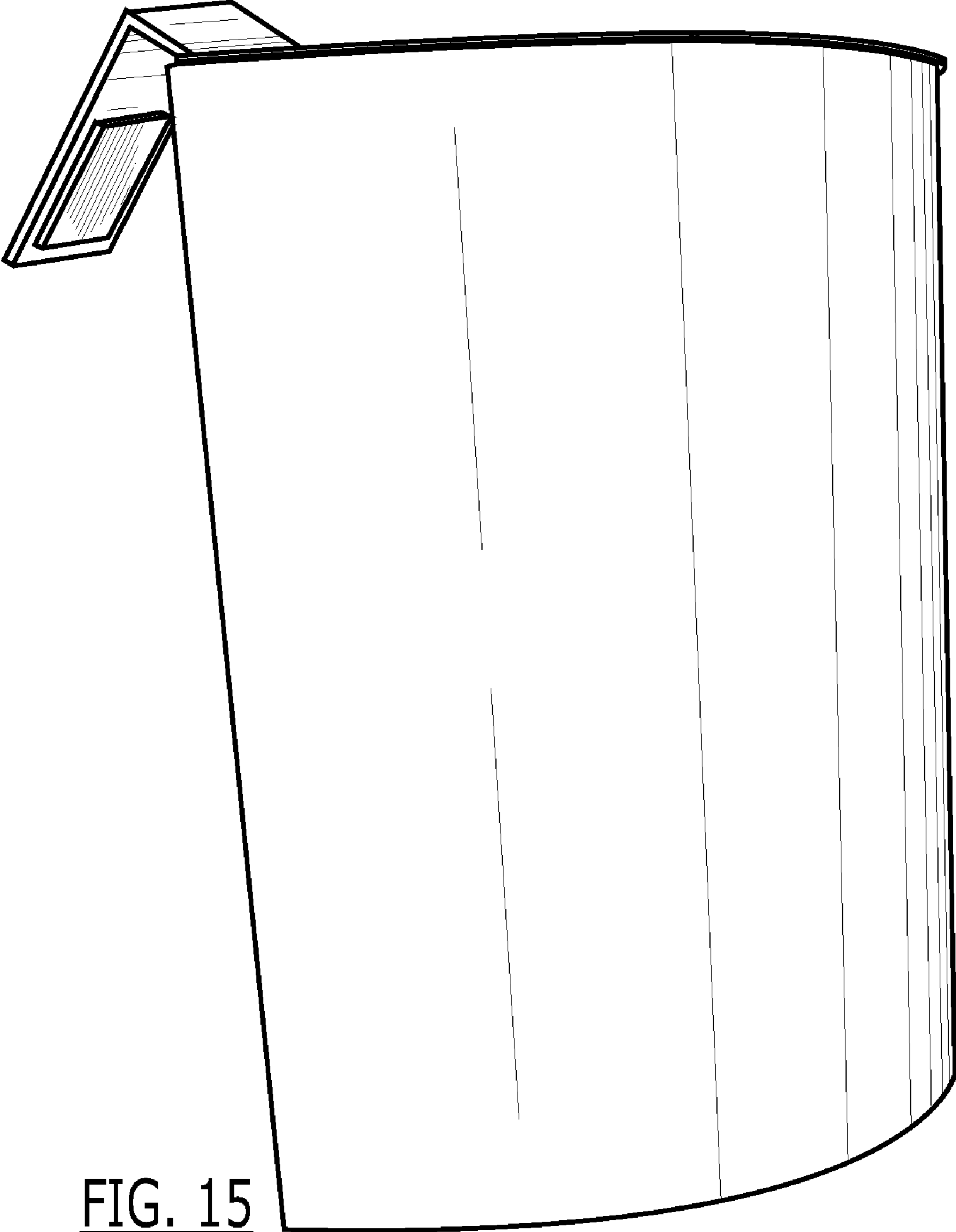

FIG. 15

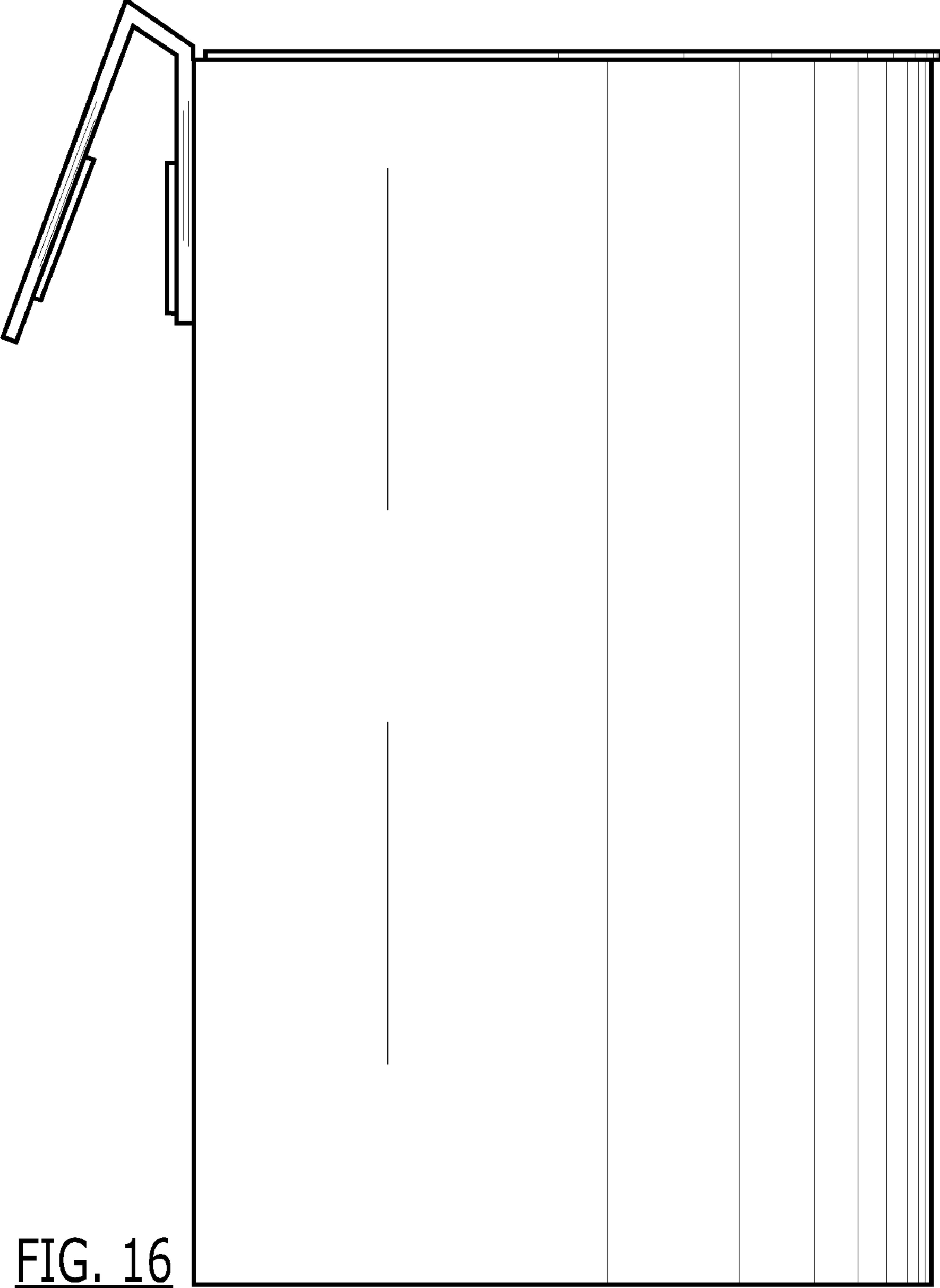

FIG. 16

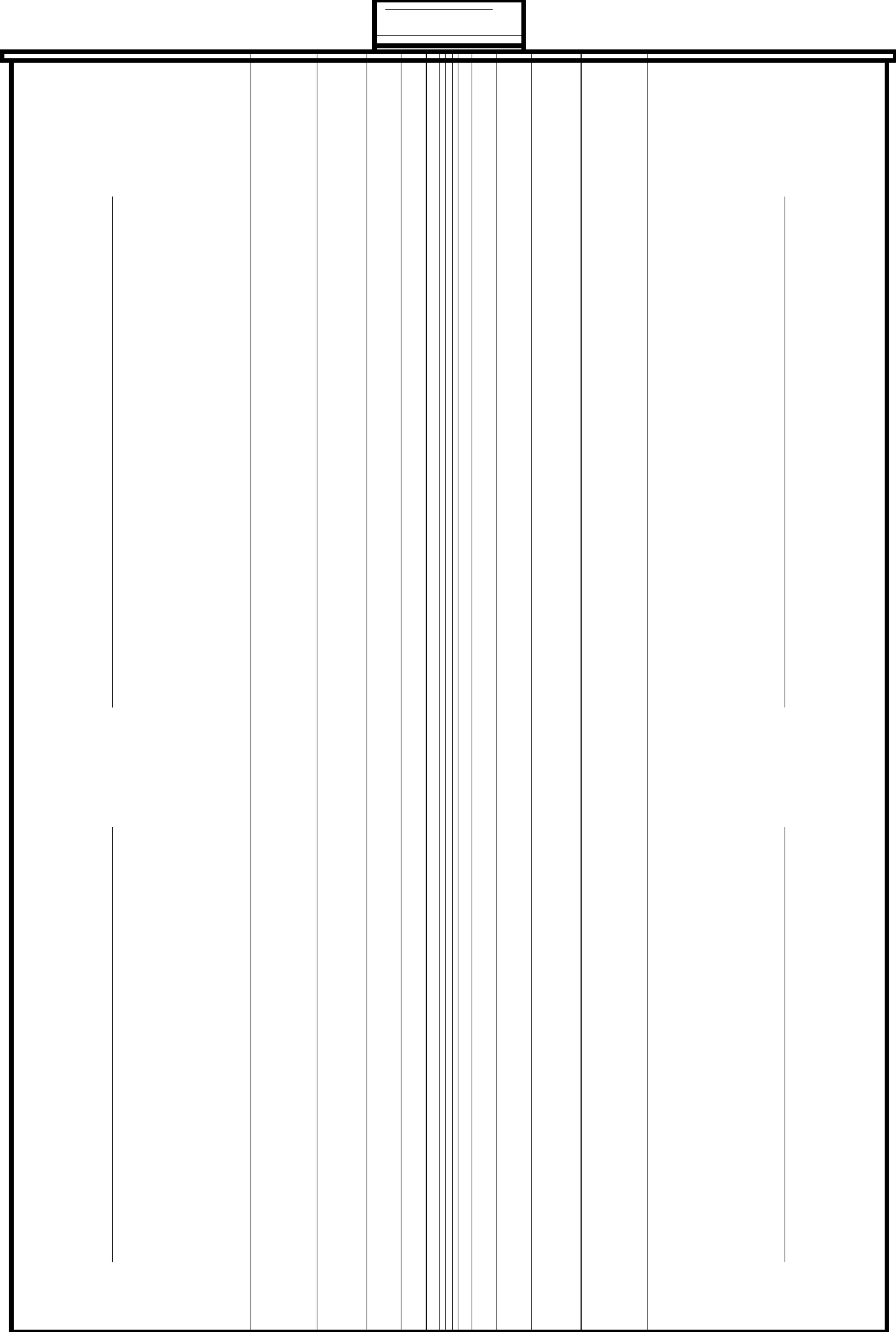

FIG. 17

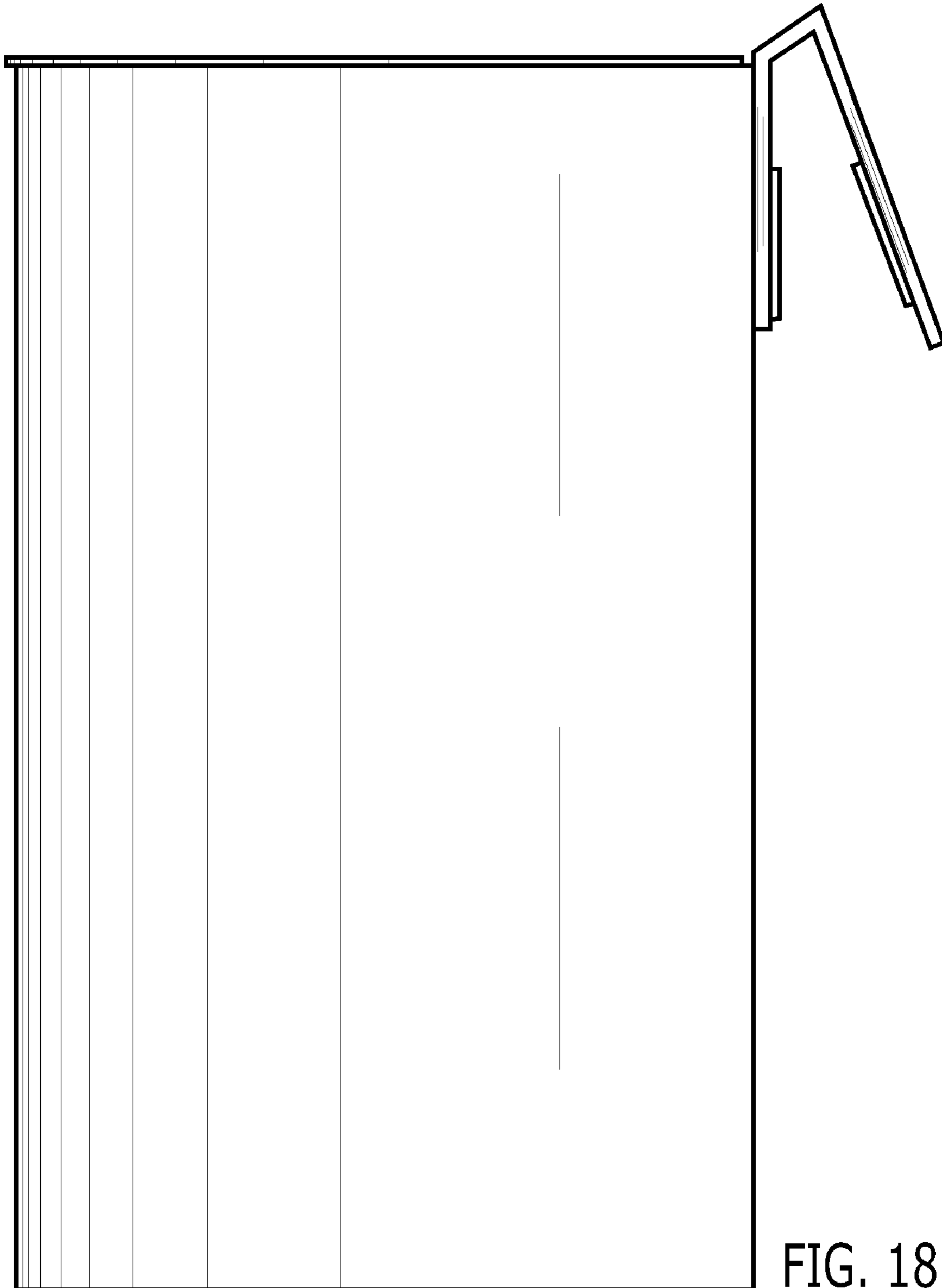

FIG. 18

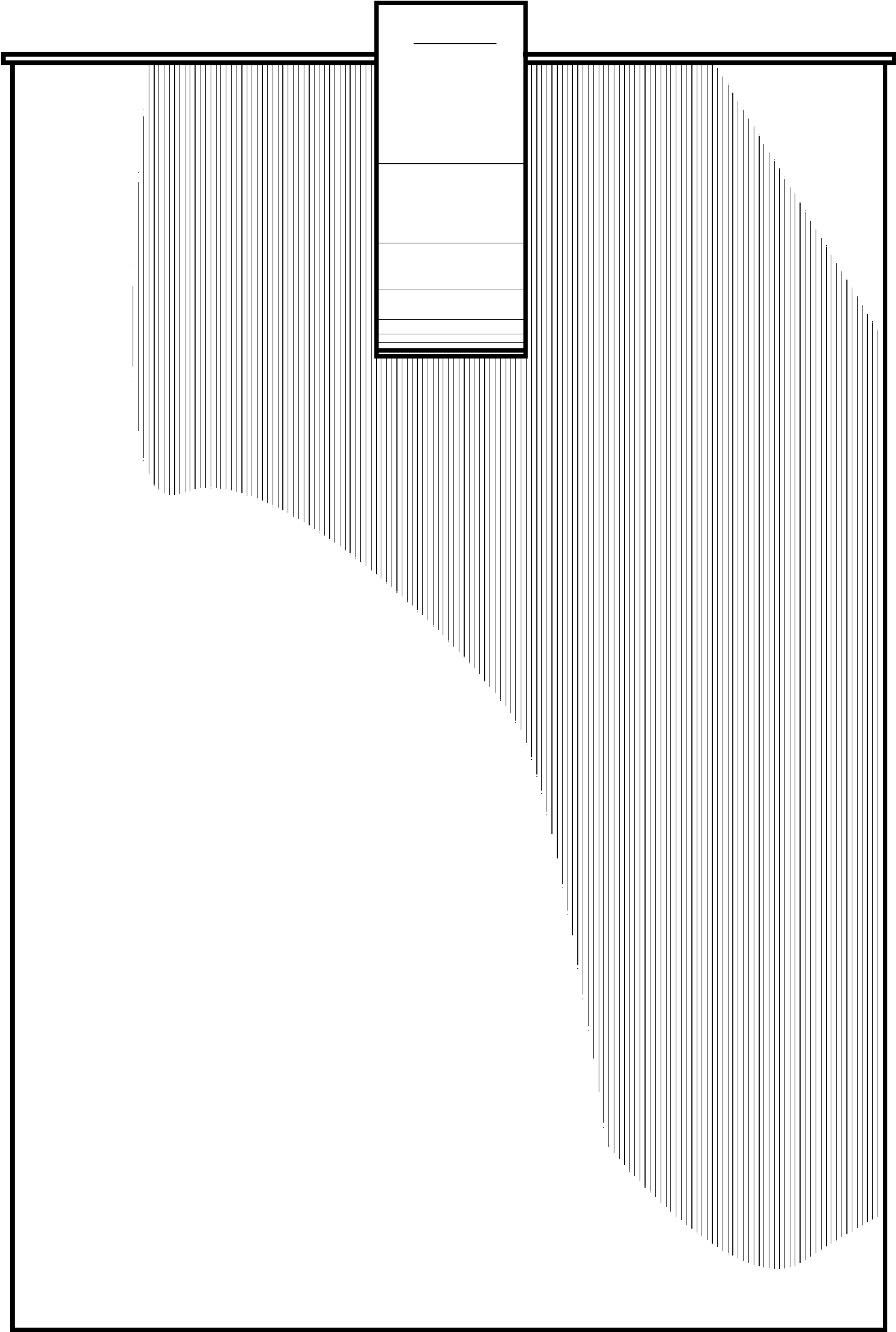

FIG. 19

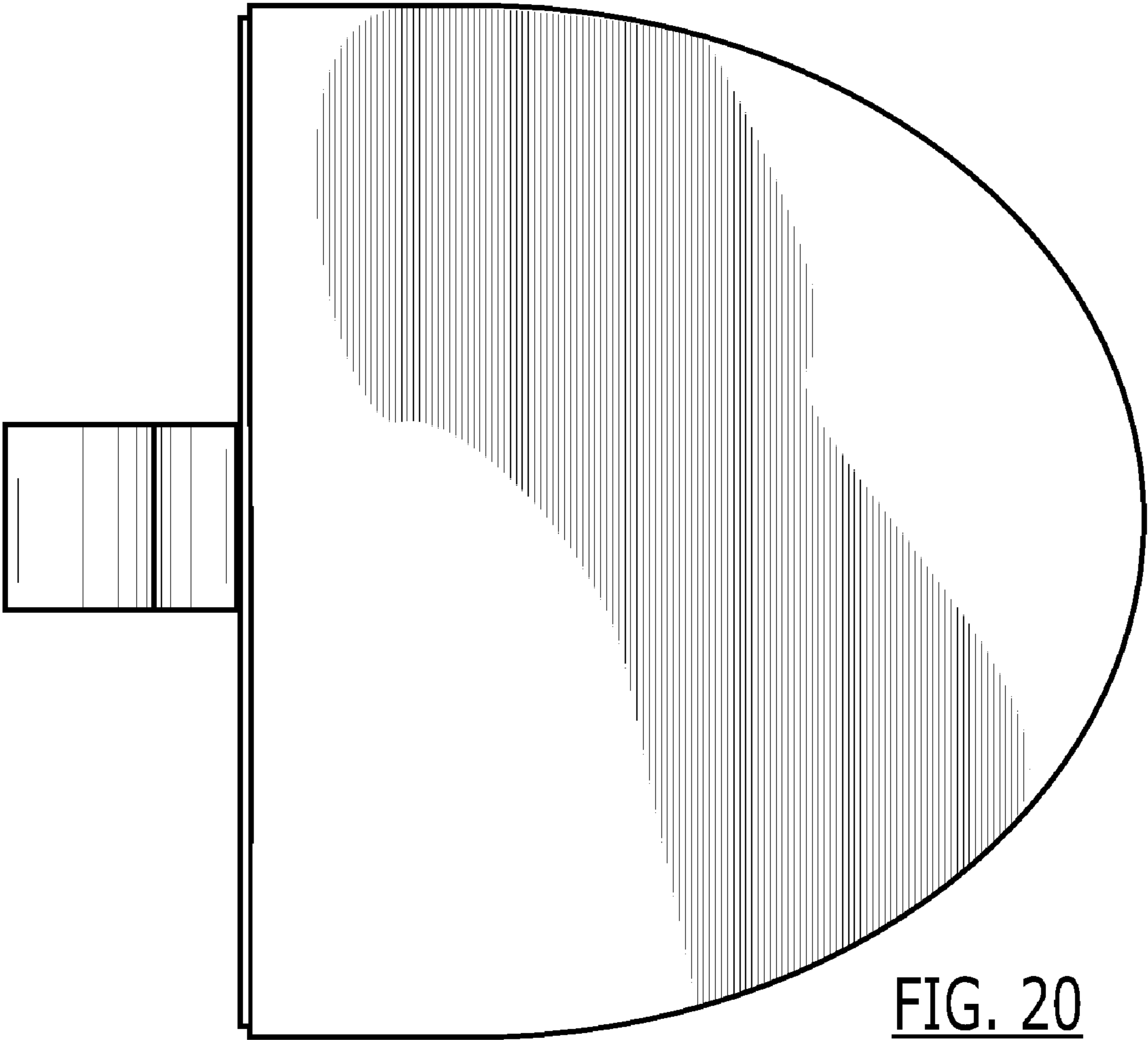

FIG. 20

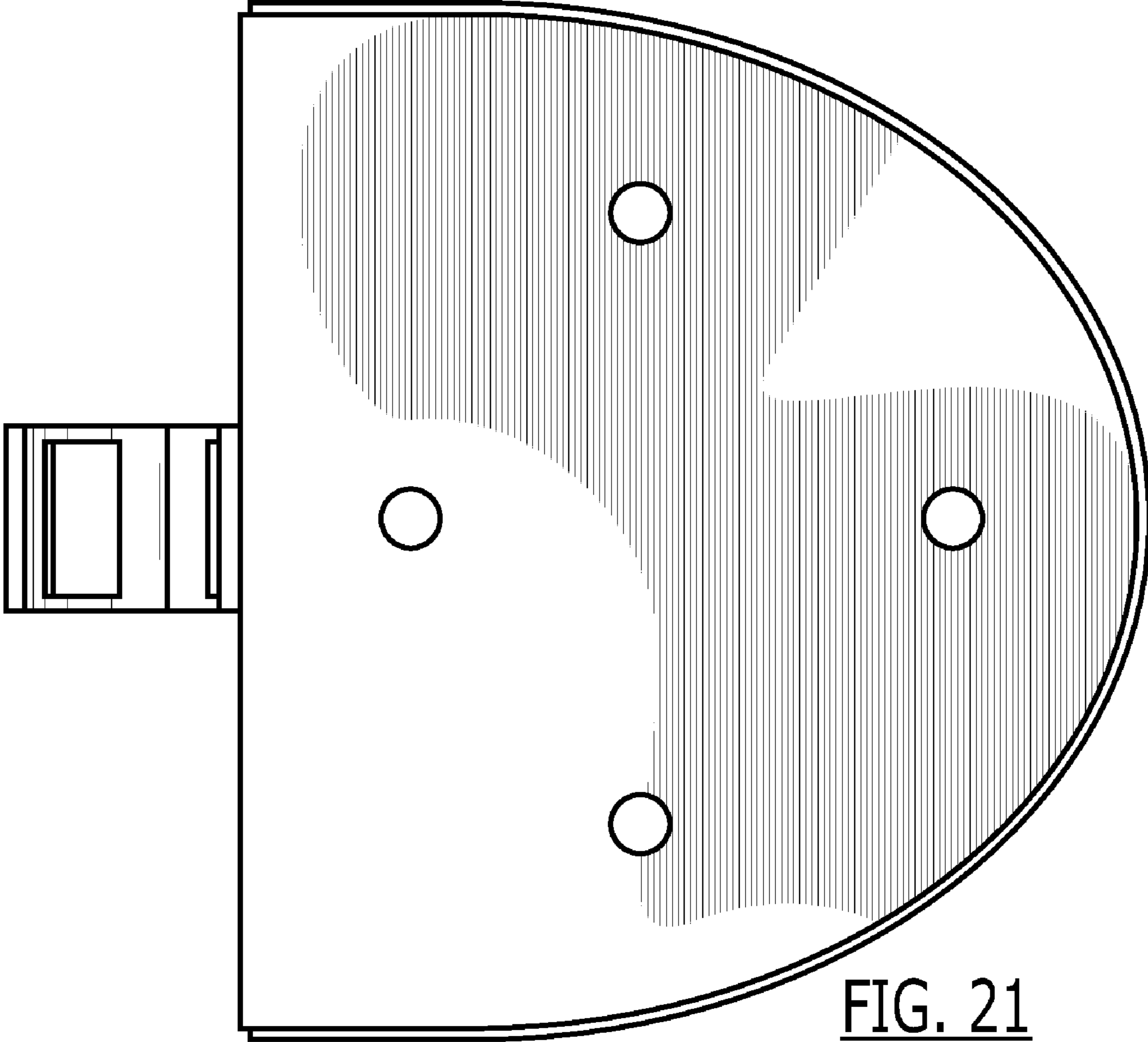

FIG. 21

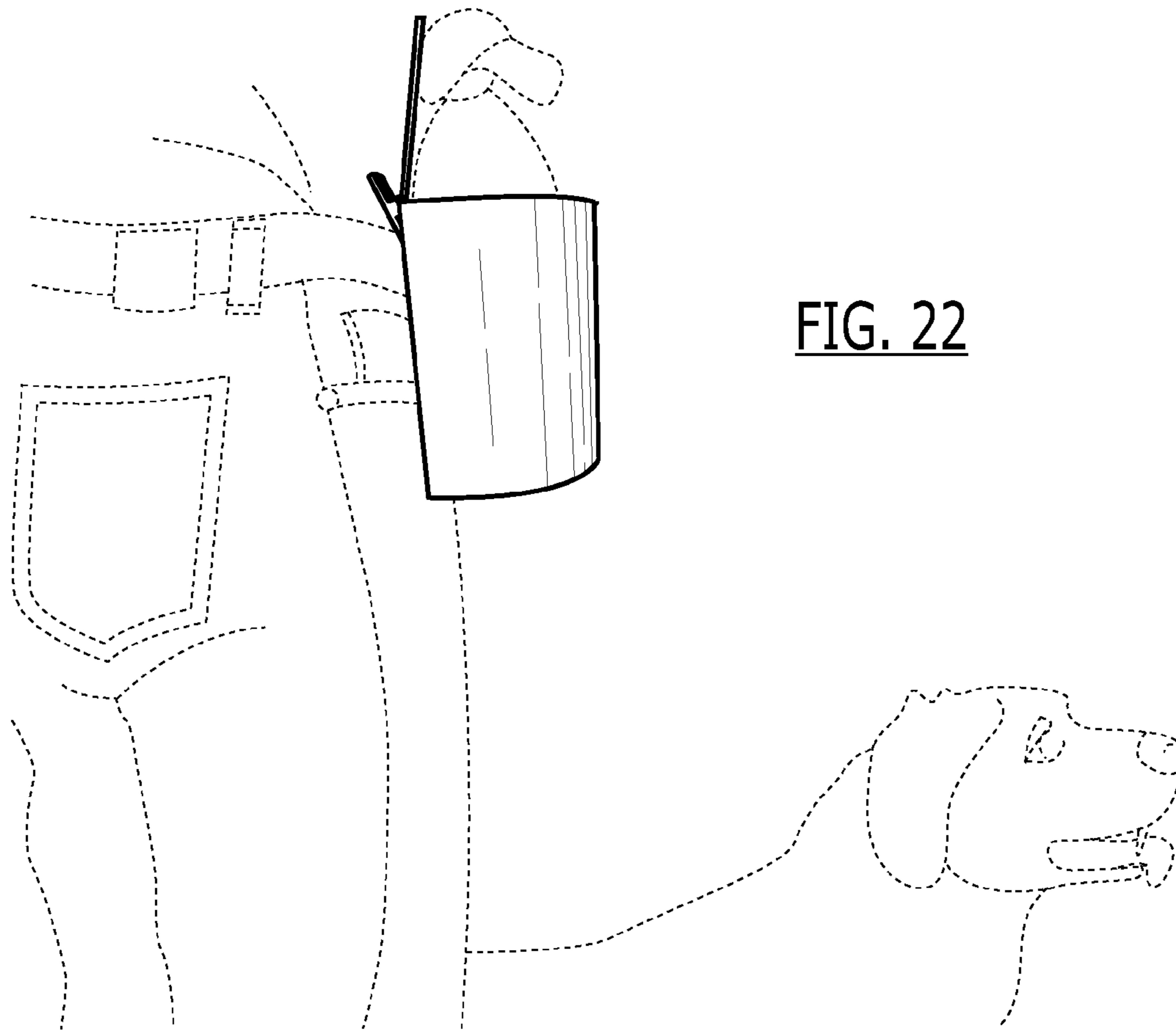

FIG. 22