



US00D615730S

(12) **United States Design Patent**
Chionna

(10) **Patent No.:** **US D615,730 S**

(45) **Date of Patent:** **** May 18, 2010**

(54) **TROUSERS**

(76) **Inventor:** **Carlo Chionna**, Via Lemonia, 54, 40133
Bologna (IT)

(**) **Term:** **14 Years**

(21) **Appl. No.:** **29/312,133**

(22) **Filed:** **Oct. 1, 2008**

(30) **Foreign Application Priority Data**

Apr. 4, 2008 (EM) 000911623

(51) **LOC (9) Cl.** **02-02**

(52) **U.S. Cl.** **D2/742**

(58) **Field of Classification Search** D2/731,
D2/738, 742; 2/227, 228, 238
See application file for complete search history.

(56) **References Cited**

U.S. PATENT DOCUMENTS

D269,560 S *	7/1983	Sheppard et al.	D2/742
4,625,336 A *	12/1986	Derderian	2/79
D293,617 S *	1/1988	Barrett	D2/742
D459,056 S *	6/2002	Serfontein	D2/742
6,421,831 B1 *	7/2002	Korff	2/69
D485,049 S *	1/2004	Newson	D2/742
D527,170 S *	8/2006	Chionna	2/742
D527,512 S *	9/2006	Chionna	D2/742
D532,958 S *	12/2006	Kent	D2/742
D537,237 S *	2/2007	Chionna	D2/742
D580,629 S *	11/2008	Adams et al.	D2/742

FOREIGN PATENT DOCUMENTS

FR 2873543 A1 * 2/2006

JP 09021006 A * 1/1997

OTHER PUBLICATIONS

Raffaello Network. <http://www.raffaello-network.com/raffies/detail.php?itemid=73275&rangeid=841>. Fall-Winter Jul. 2006. 9.2 by Carlo Chionna Kids Clothing.*

Yoox. <http://www.yoox.com/item.asp?cod10=36129788&TP=11227>. Date Unknown: Viewed Apr. 2009. 9.2 by Carlo Chionna: Collection Yoox Printemps-Ete.*

Yoox. <http://www.yoox.com/item.asp?tskay=B490DC11&cod10=42127403&TP=1390>. Date Unknown: Viewed Apr. 2009. 9.2 by Carlo Chionna: Yoox-Kollektion: Fruhling-Sommer.*

* cited by examiner

Primary Examiner—Ian Simmons

Assistant Examiner—R. Johnson

(74) *Attorney, Agent, or Firm*—Fay Sharpe LLP

(57) **CLAIM**

The ornamental design for trousers, as shown and described.

DESCRIPTION

FIG. 1 is a front perspective view of trousers showing my new design,

FIG. 2 is a front view,

FIG. 3 is a right side view,

FIG. 4 is a rear view,

FIG. 5 is a left side view,

FIG. 6 is a top view; and,

FIG. 7 is a bottom view.

The broken lines in FIGS. 1–7 are for illustrative purposes only and form no part of the claimed design.

1 Claim, 4 Drawing Sheets

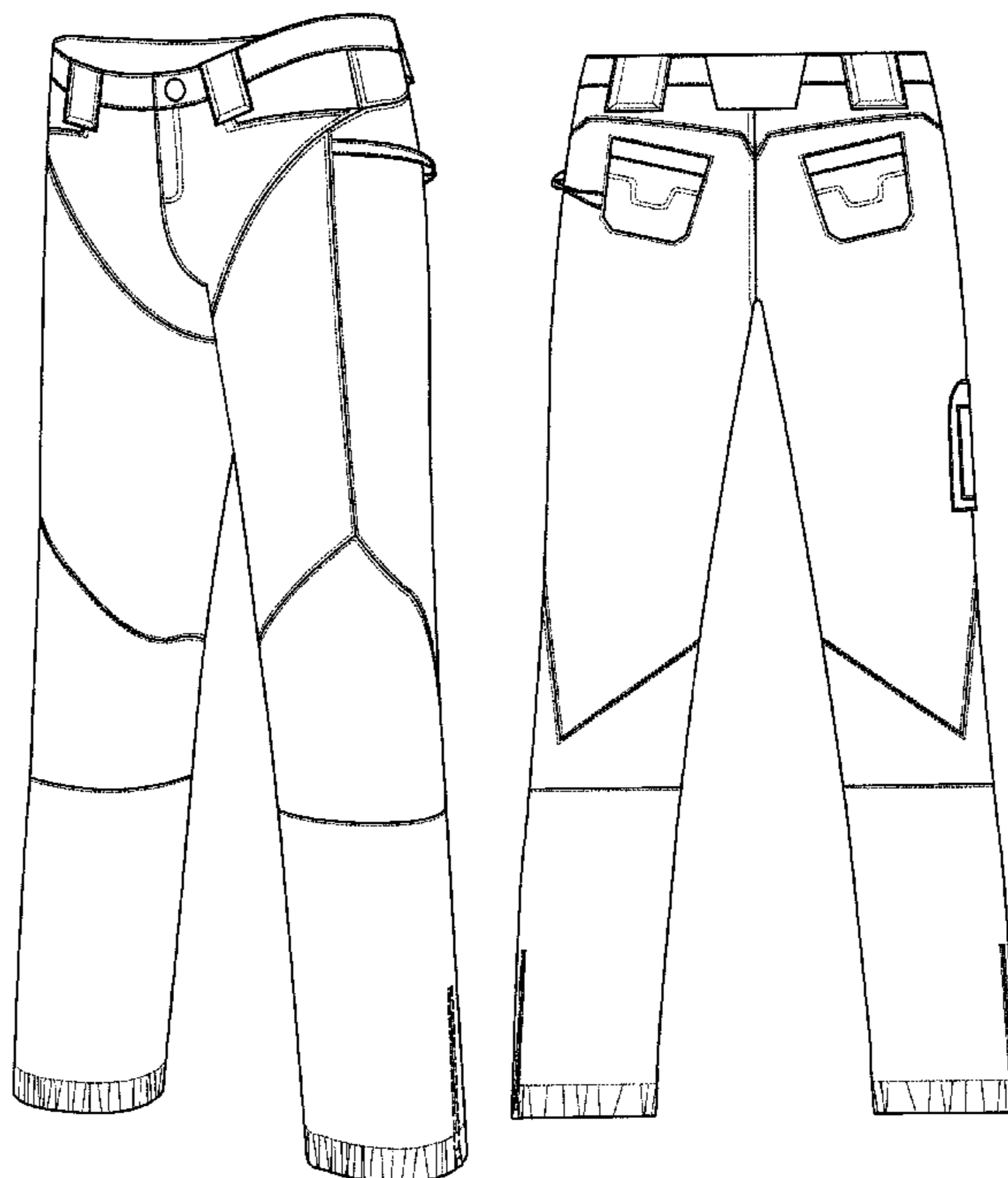

FIG. 1

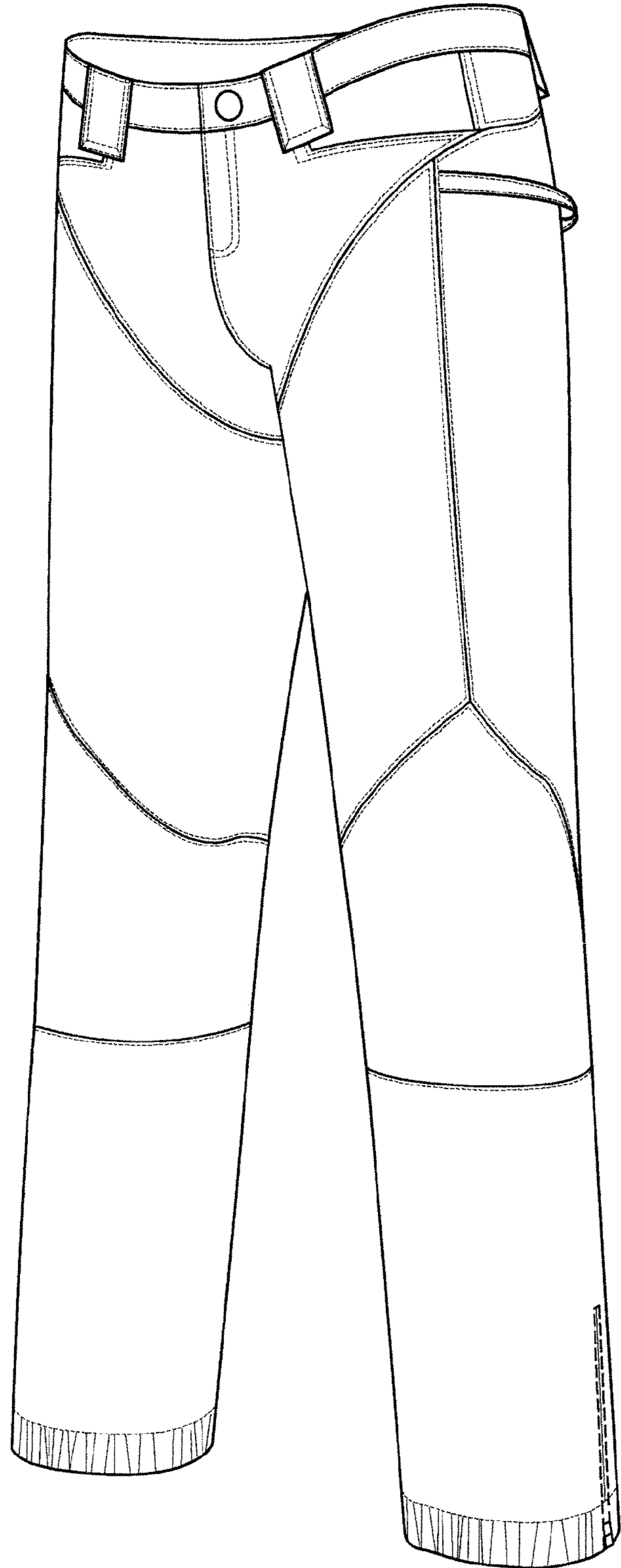

FIG.2

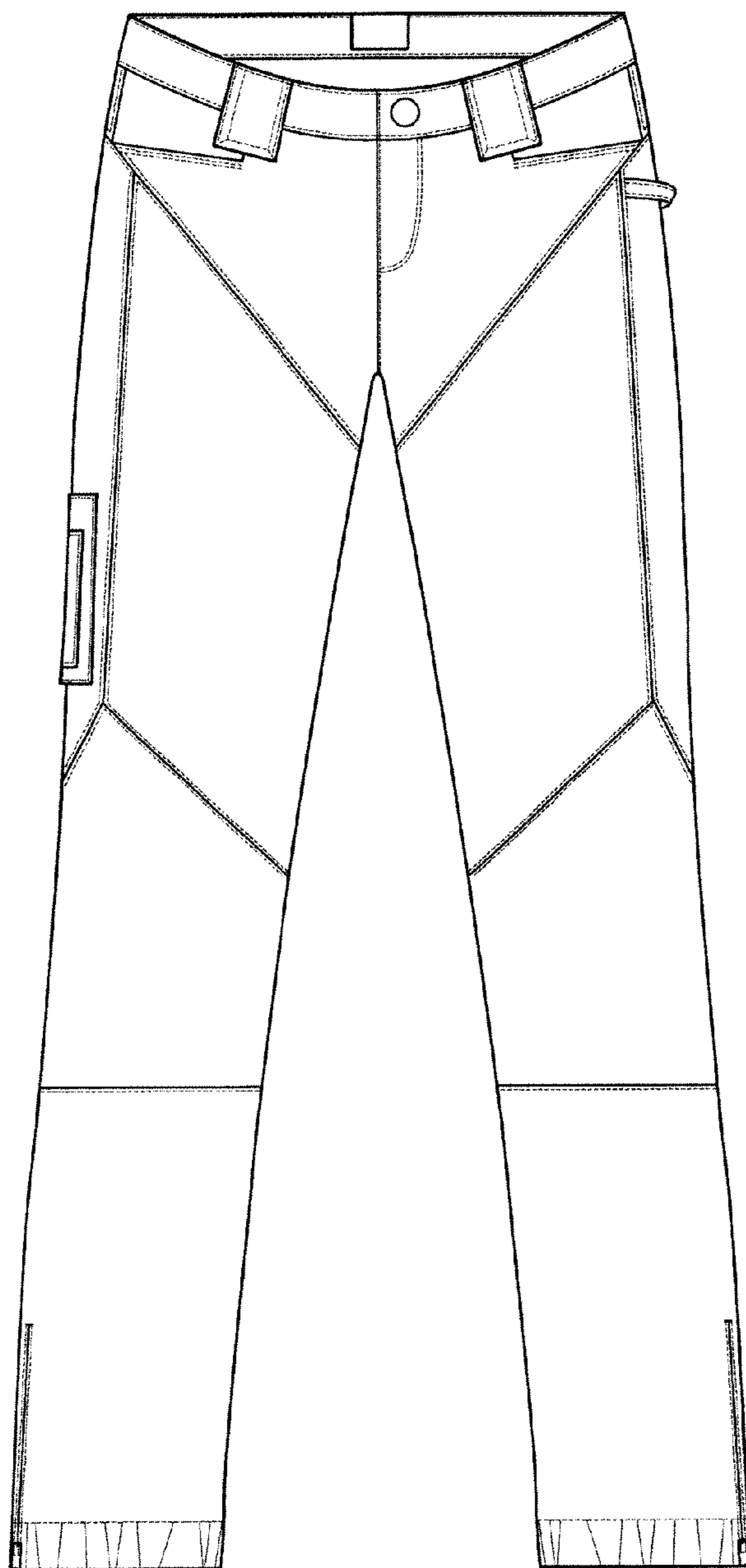

FIG.3

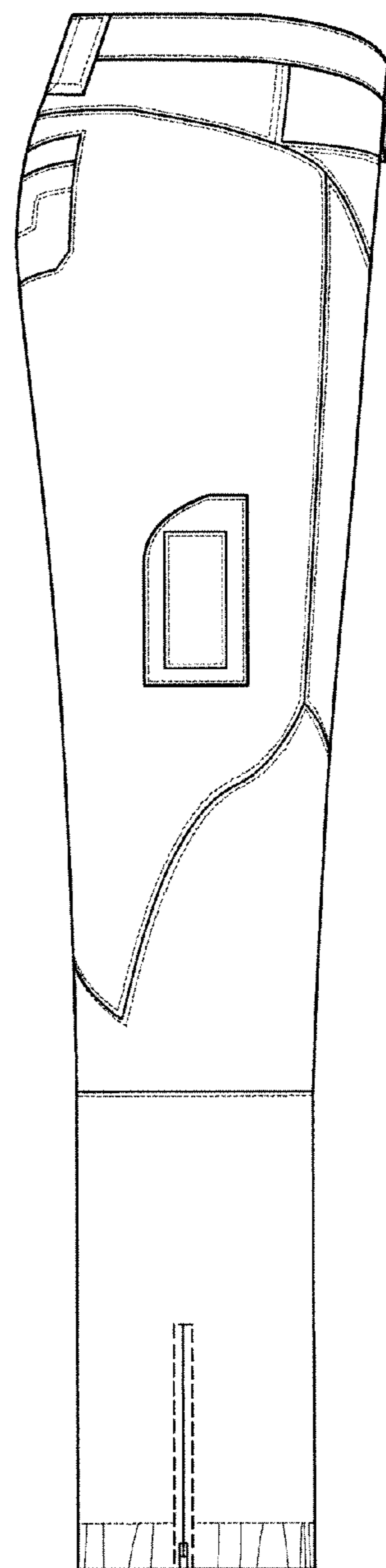

FIG.4

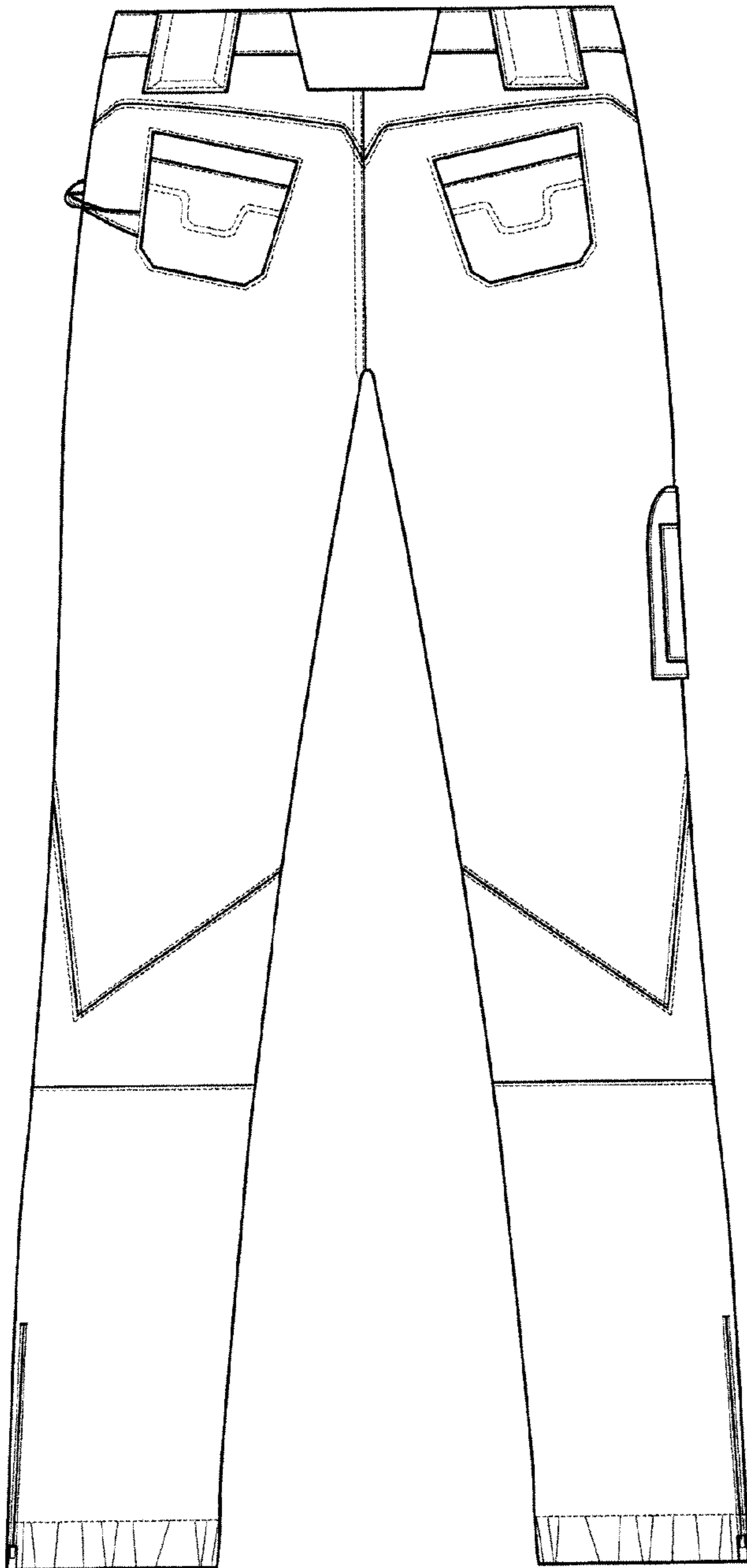

FIG.5

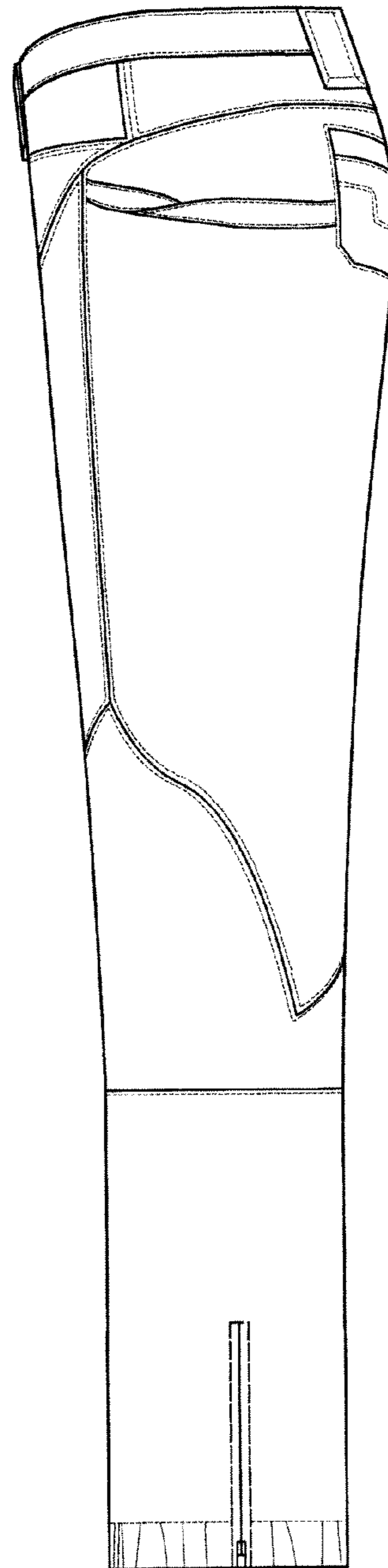

FIG. 6

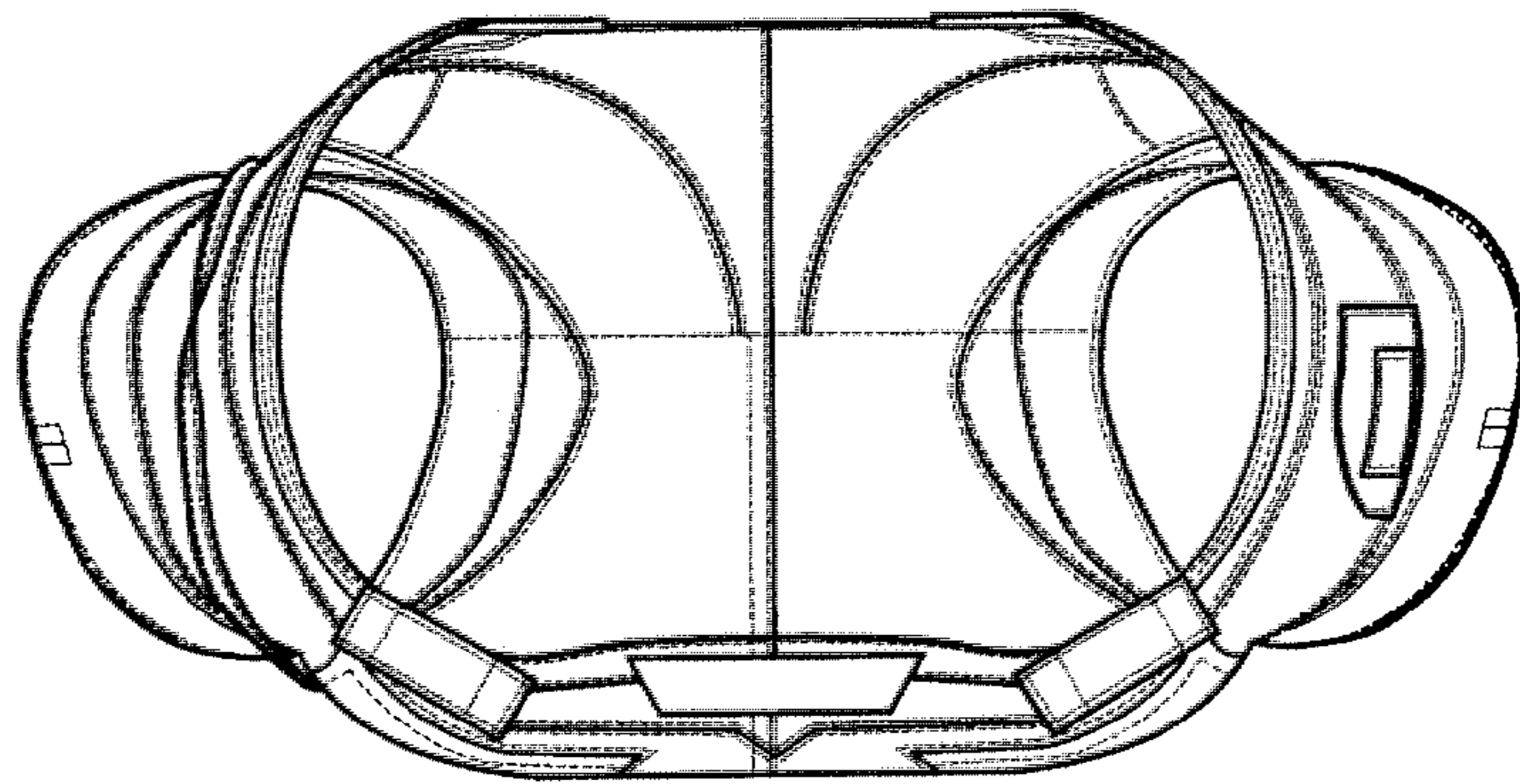

FIG. 7

