



US00D615715S

(12) **United States Design Patent**
Zielinski

(10) **Patent No.:** **US D615,715 S**

(45) **Date of Patent:** **** May 11, 2010**

(54) **SPORTS EQUIPMENT DRYING APPARATUS**

(76) Inventor: **Reuben Q. Zielinski**, 12824 Hanley Dr., Fishers, IN (US) 46037

(**) Term: **14 Years**

(21) Appl. No.: **29/298,247**

(22) Filed: **Nov. 30, 2007**

(51) **LOC (9) Cl.** **15-05**

(52) **U.S. Cl.** **D32/8**

(58) **Field of Classification Search** D32/8,
D32/58, 59, 25; 34/90, 103, 104, 105, 106,
34/202, 239, 240; 211/34, 35, 37
See application file for complete search history.

5,953,830 A	9/1999	Jannach	
6,005,227 A	12/1999	Pappas	
6,216,887 B1	4/2001	Soo	
6,327,792 B1	12/2001	Hebert	
D487,831 S	3/2004	Savoie	
6,766,594 B2	7/2004	DuRapau	
6,796,053 B2	9/2004	Lurie	
6,880,711 B2	4/2005	Collier	
7,083,055 B1	8/2006	Ambrosat	
D581,109 S *	11/2008	Totz D32/8
2005/0097768 A1 *	5/2005	Burns et al. 34/90
2005/0204579 A1	9/2005	Rosseau et al.	
2006/0042114 A1 *	3/2006	Robson et al. 34/90

* cited by examiner

Primary Examiner—Cynthia E Ramirez
(74) *Attorney, Agent, or Firm*—Law Offices of Donald Cox, LLC

(56) **References Cited**

U.S. PATENT DOCUMENTS

D183,499 S	9/1958	Simpson	
3,513,564 A	5/1970	Gramprrie	
5,058,289 A	10/1991	Guindon	
D333,731 S	3/1993	Klein et al.	
5,222,308 A *	6/1993	Barker et al. 34/104
5,287,636 A	2/1994	Lafleur et al.	
D349,788 S *	8/1994	Laferriere et al. D32/1
5,369,893 A *	12/1994	Perito 34/239
5,379,525 A	1/1995	Raynor	
D355,288 S	2/1995	Mallen	
5,394,619 A	3/1995	Kaplan	
5,406,717 A	4/1995	Dofka	
5,412,928 A	5/1995	Reithel	
5,469,635 A *	11/1995	Lamontagne et al. 34/104
5,548,100 A	8/1996	Miller	
5,592,750 A	1/1997	Eichten	
5,604,993 A	2/1997	Auckerman	
D394,926 S	6/1998	Lindsay	
D401,705 S	11/1998	Jones	
5,862,606 A	1/1999	Jannach	
5,862,924 A	1/1999	Dumont	
D412,231 S *	7/1999	Williams et al. D32/58

(57) **CLAIM**

The ornamental design for a sports equipment drying apparatus, as shown and described.

DESCRIPTION

FIG. 1 is a perspective view of a sports equipment drying apparatus showing my new design;
FIG. 2 is a front view thereof;
FIG. 3 is a rear view thereof;
FIG. 4 is a right side view thereof;
FIG. 5 is a left side view thereof;
FIG. 6 is a plan view thereof; and,
FIG. 7 is an inverted plan view thereof.

The broken lines showing, for example, a fan/heater assembly housing, an electrical cord, tabs, pipe joints and air vents in FIGS. 1–7 are included for the purpose of illustrating environmental structure only and form no part of the claimed design.

1 Claim, 7 Drawing Sheets

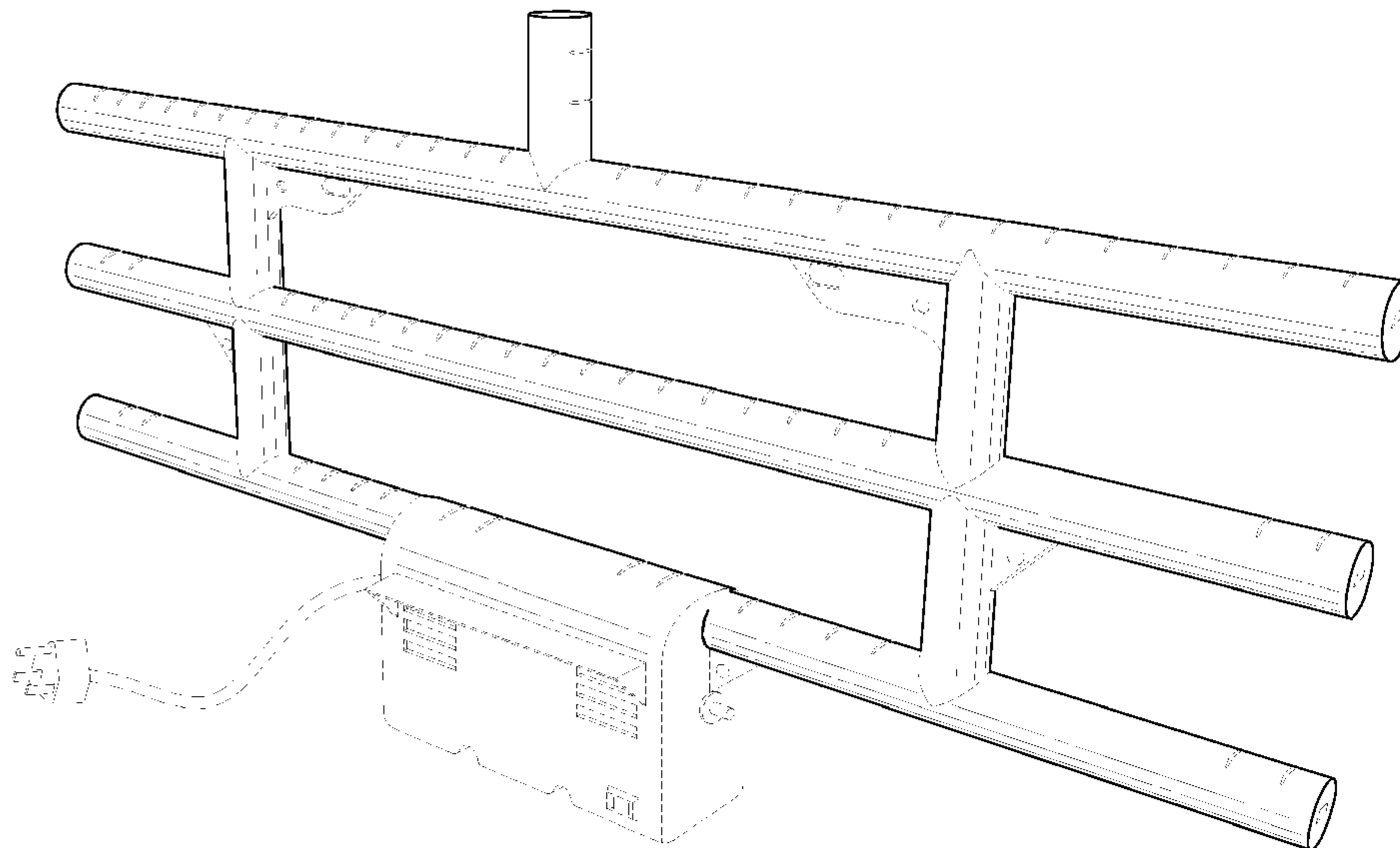

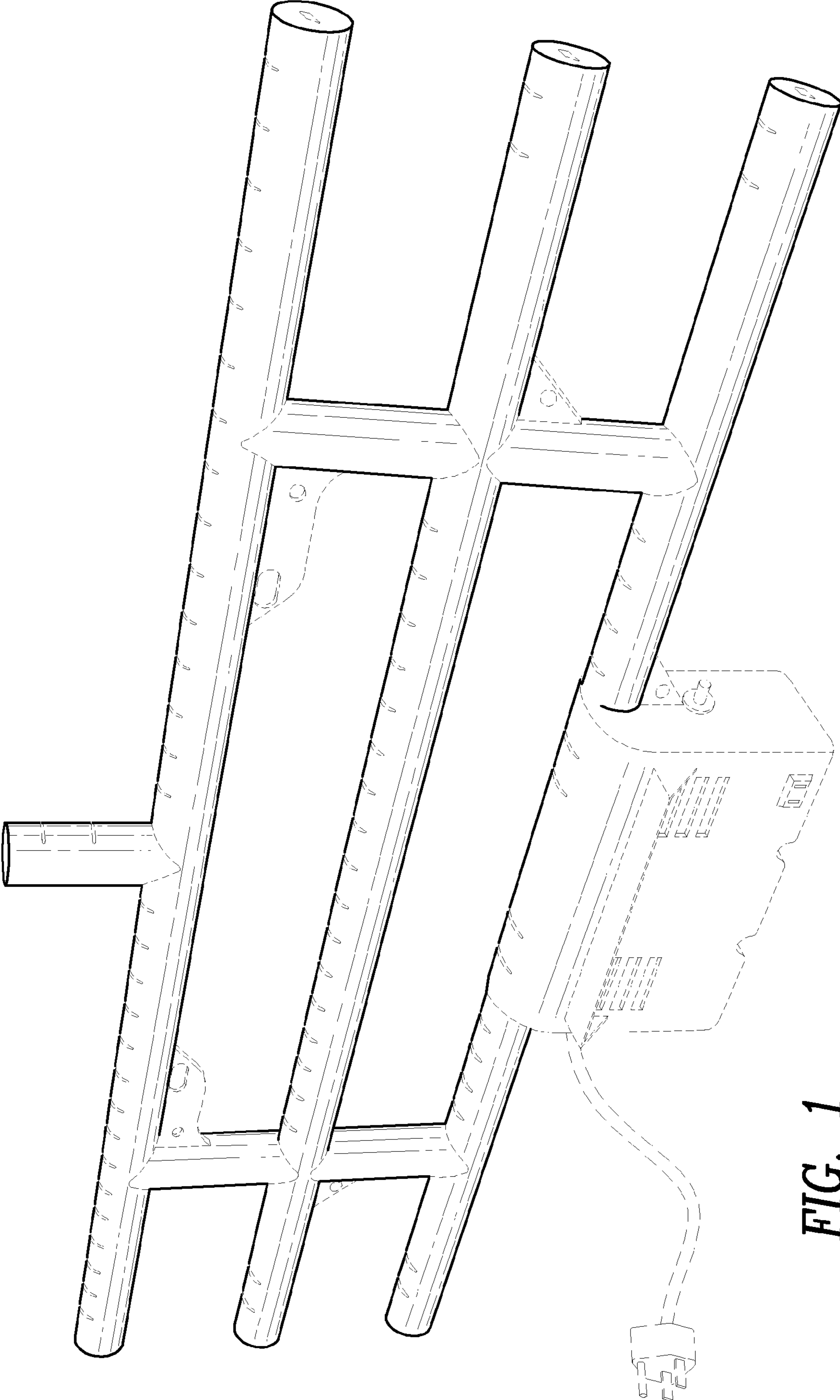

FIG. 1

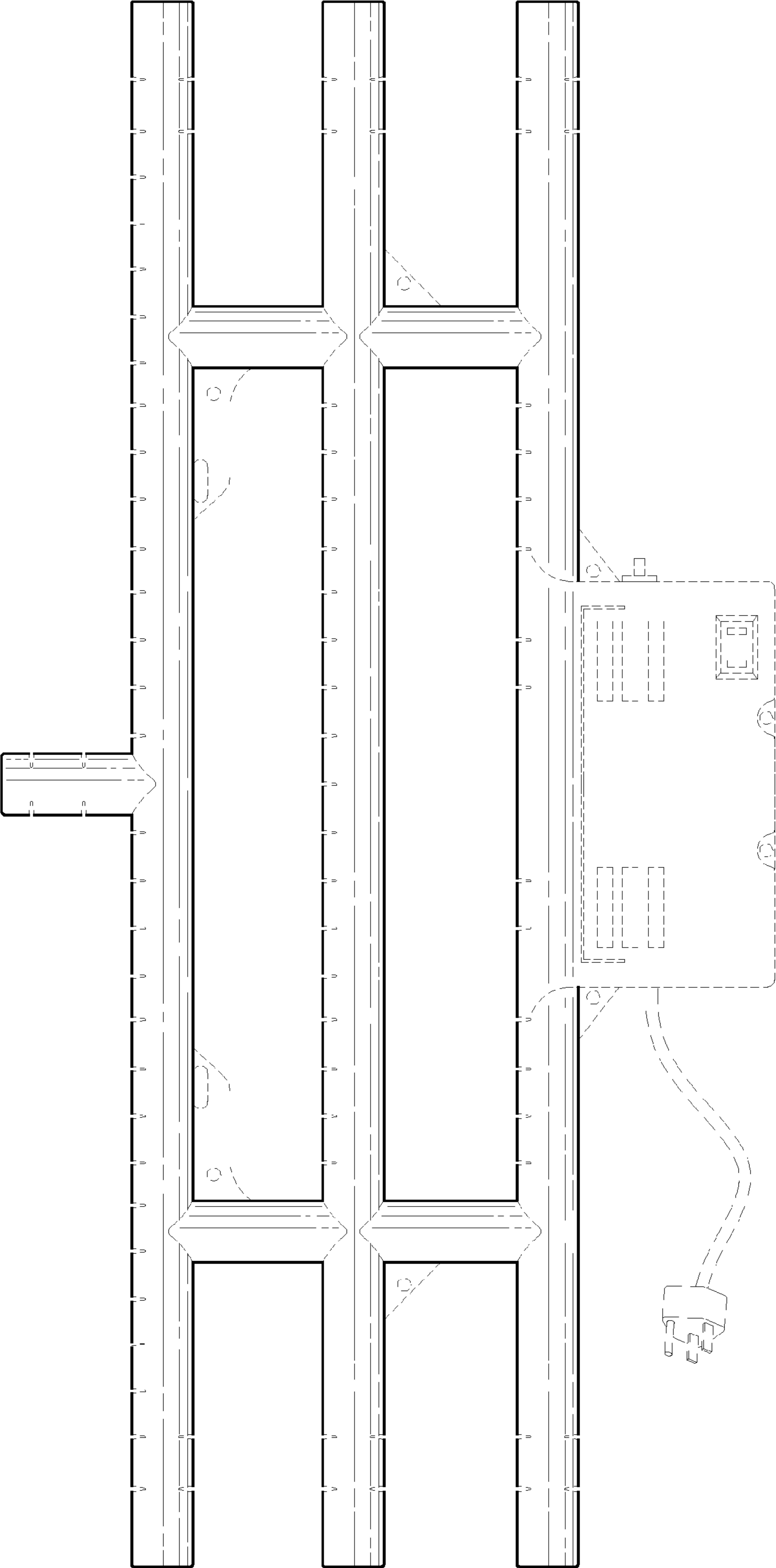

FIG. 2

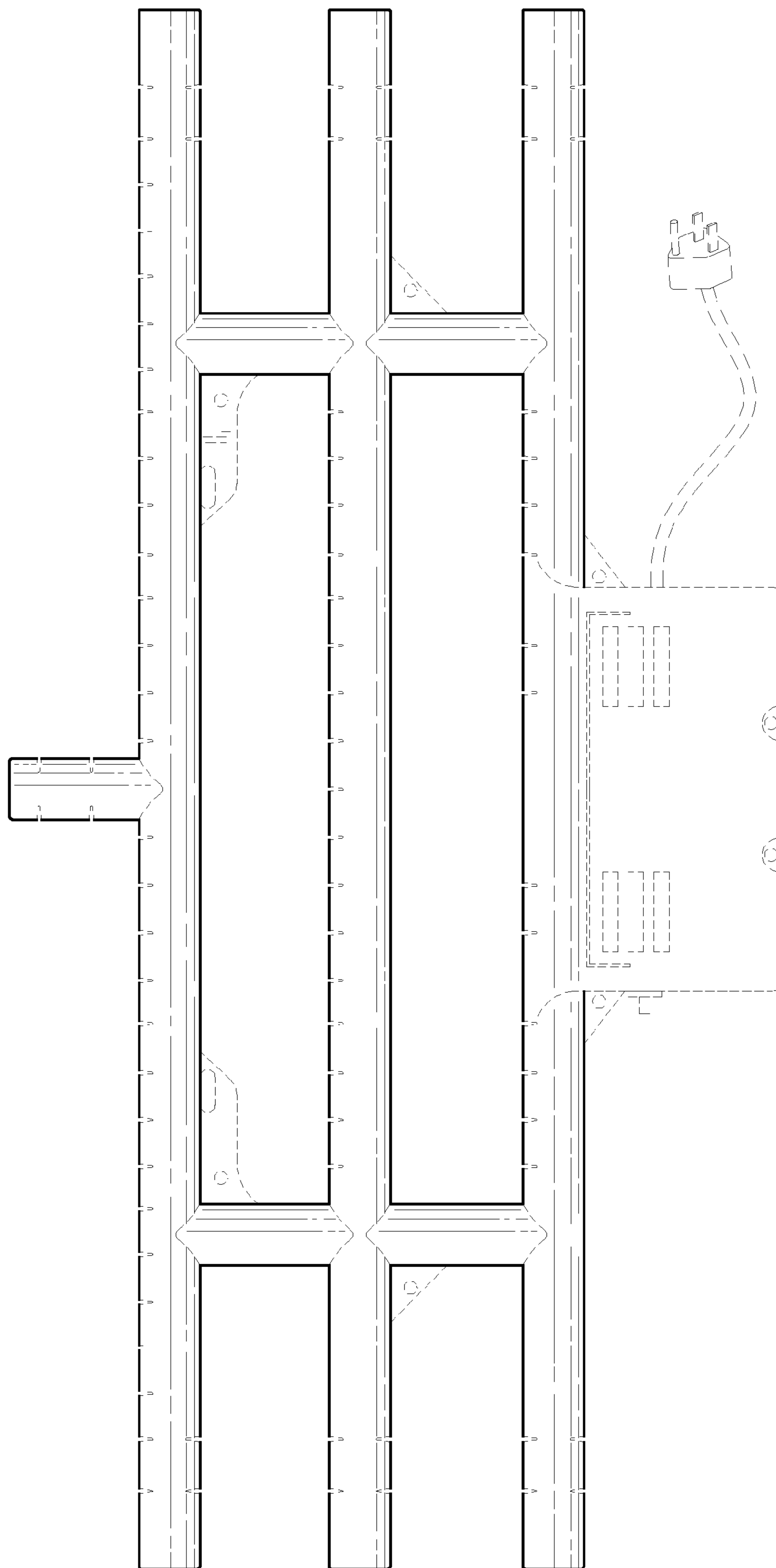

FIG. 3

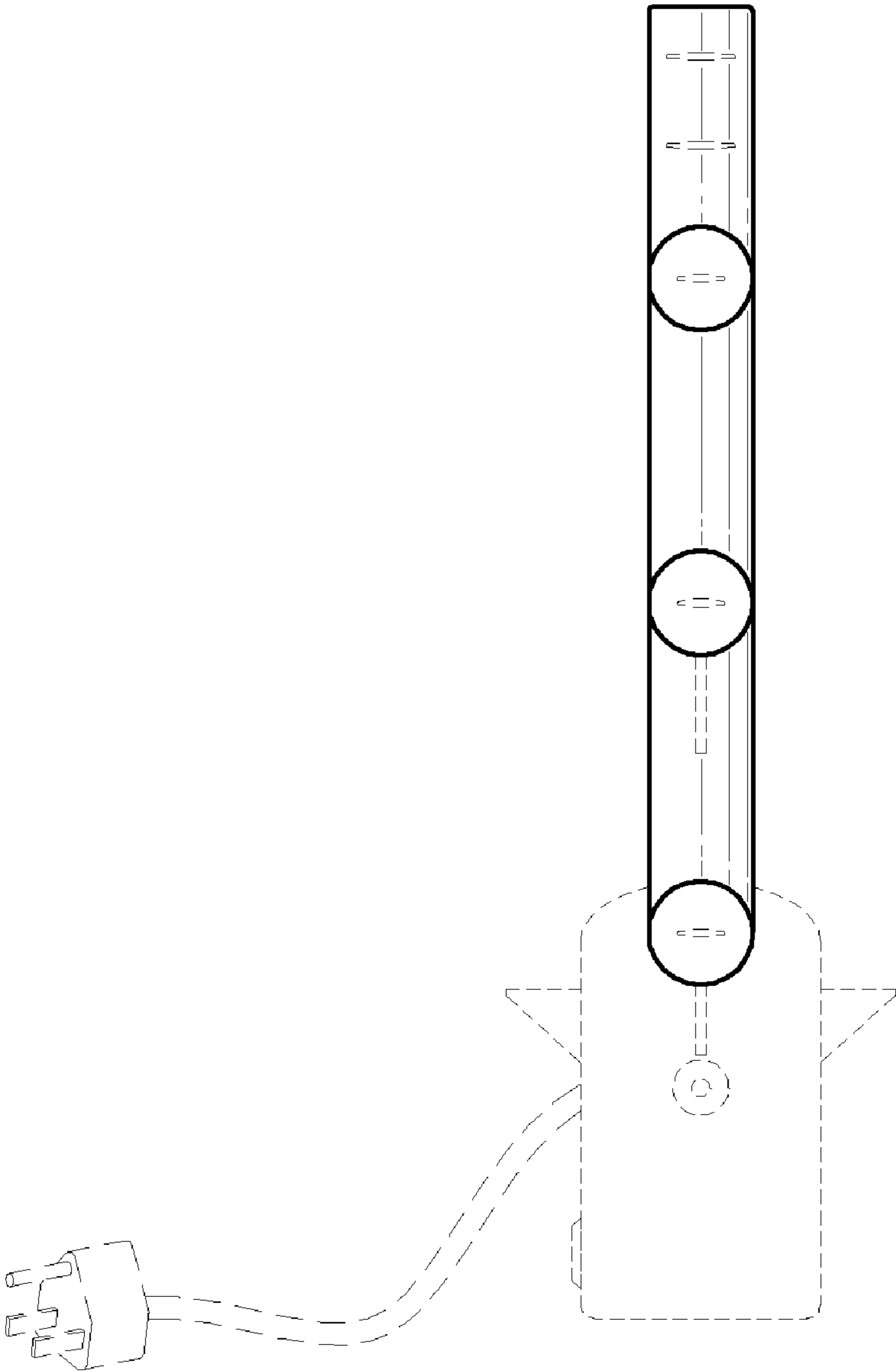

FIG. 4

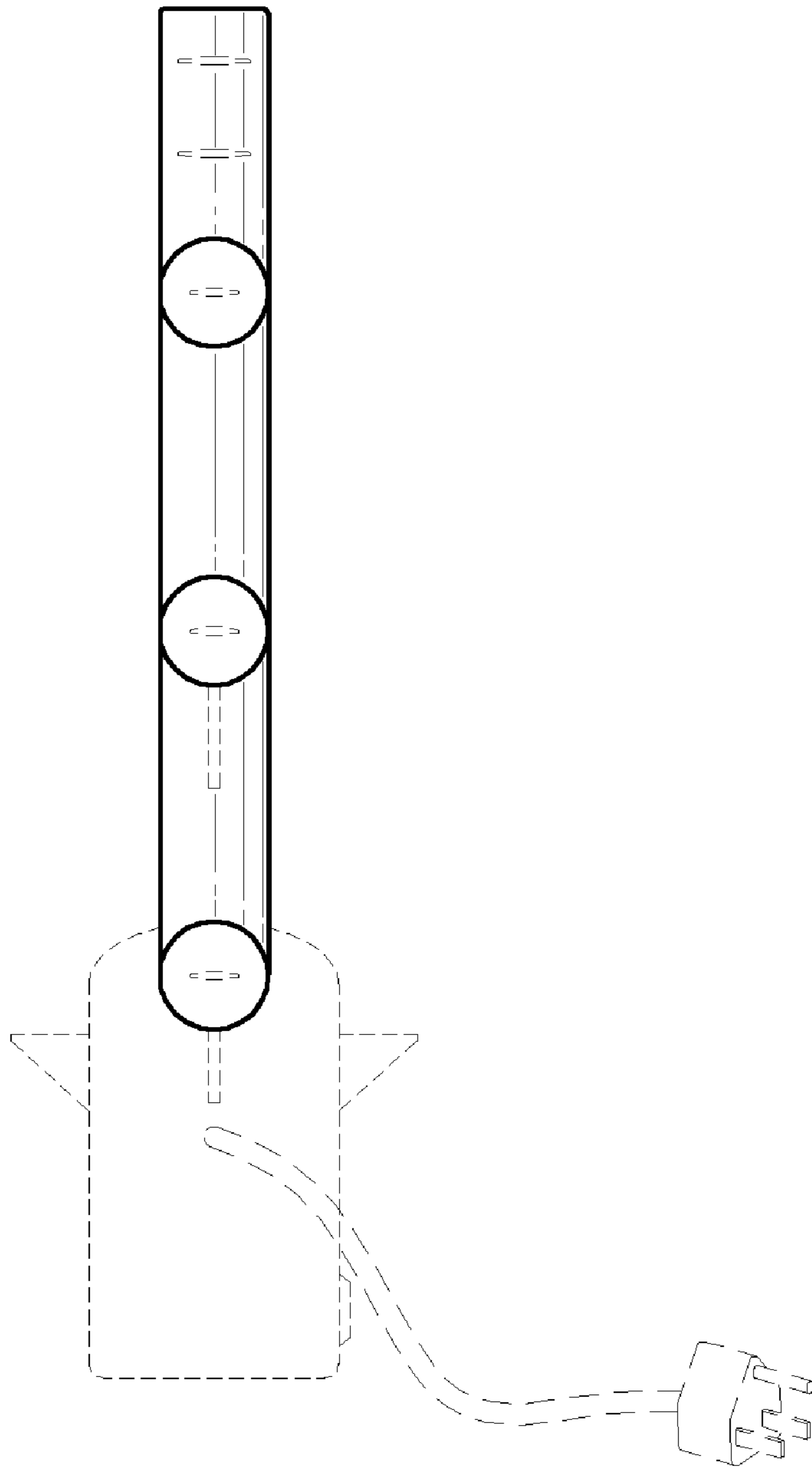

FIG. 5

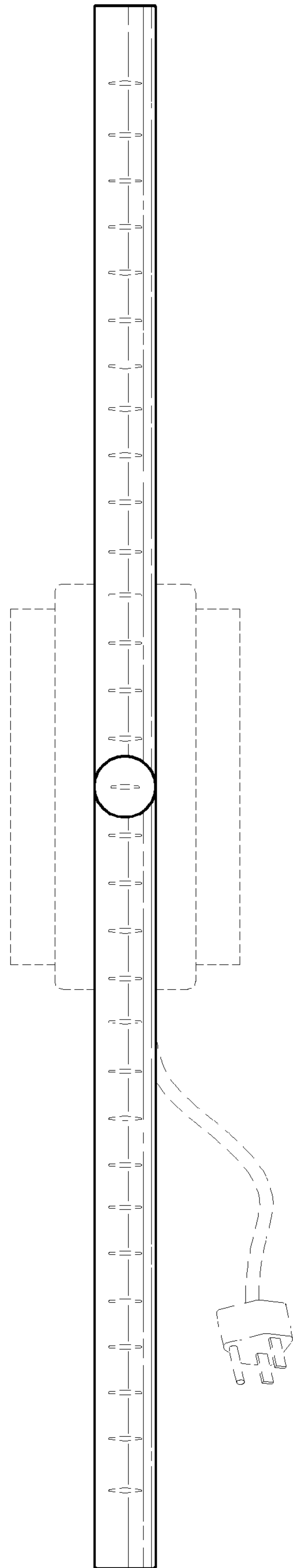

FIG. 6

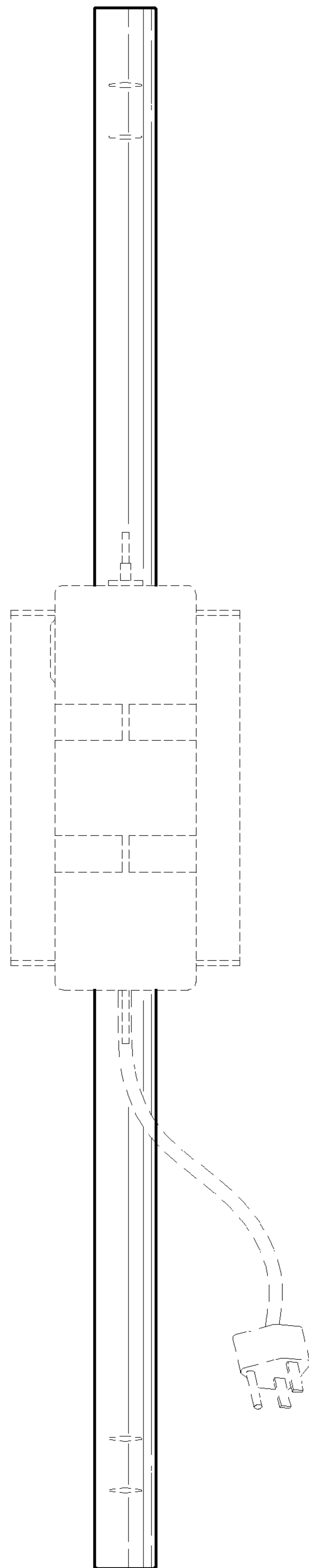

FIG. 7