



US00D615615S

(12) **United States Design Patent**  
**Cheng**

(10) **Patent No.:** **US D615,615 S**

(45) **Date of Patent:** **\*\* May 11, 2010**

(54) **WATER SPRAY GUN**

(57) **CLAIM**

(76) Inventor: **Chi-Han Cheng**, P.O. Box 215,  
Taichung (TW) 40099

The ornamental design for a water spray gun, as shown and described.

(\*\*) Term: **14 Years**

**DESCRIPTION**

(21) Appl. No.: **29/311,917**

FIG. 1 is a perspective view of a water spray gun of the design.  
FIG. 2 is a front elevational view of a water spray gun of the design.

(22) Filed: **Jul. 31, 2009**

(51) **LOC (9) Cl.** ..... **23-01**

FIG. 3 is a rear elevational view of a water spray gun of the design.

(52) **U.S. Cl.** ..... **D23/226**

(58) **Field of Classification Search** ..... D23/213,  
D23/223, 226; 239/525-527, 532  
See application file for complete search history.

FIG. 4 is a left side elevational view of a water spray gun of the design.

(56) **References Cited**

FIG. 5 is a right side elevational view of a water spray gun of the design.

**U.S. PATENT DOCUMENTS**

FIG. 6 is a top plan view of a water spray gun of the design; and,

D449,671 S	*	10/2001	Wang	.....	D23/226
D468,804 S	*	1/2003	Nien	.....	D23/226
6,702,206 B2	*	3/2004	Wu	.....	239/526
D553,711 S	*	10/2007	Chih	.....	D23/226
D554,234 S	*	10/2007	Chih	.....	D23/226

FIG. 7 is a bottom plan view of a water spray gun of the design.

\* cited by examiner

The broken line showing of the spray gun nozzle is included for the purpose of illustrating and forms no part of the claimed design.

*Primary Examiner*—Robin V Webster

**1 Claim, 7 Drawing Sheets**

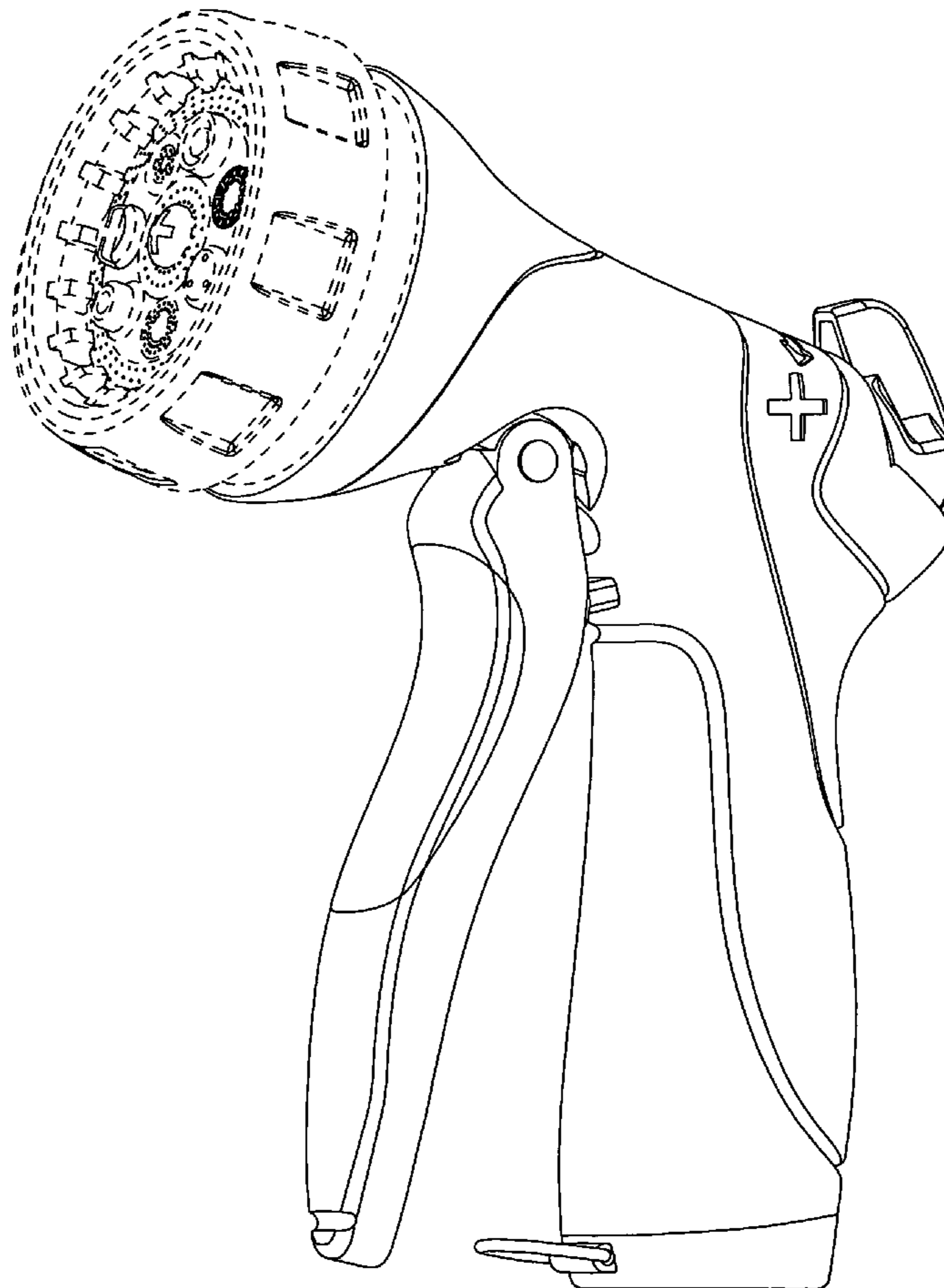

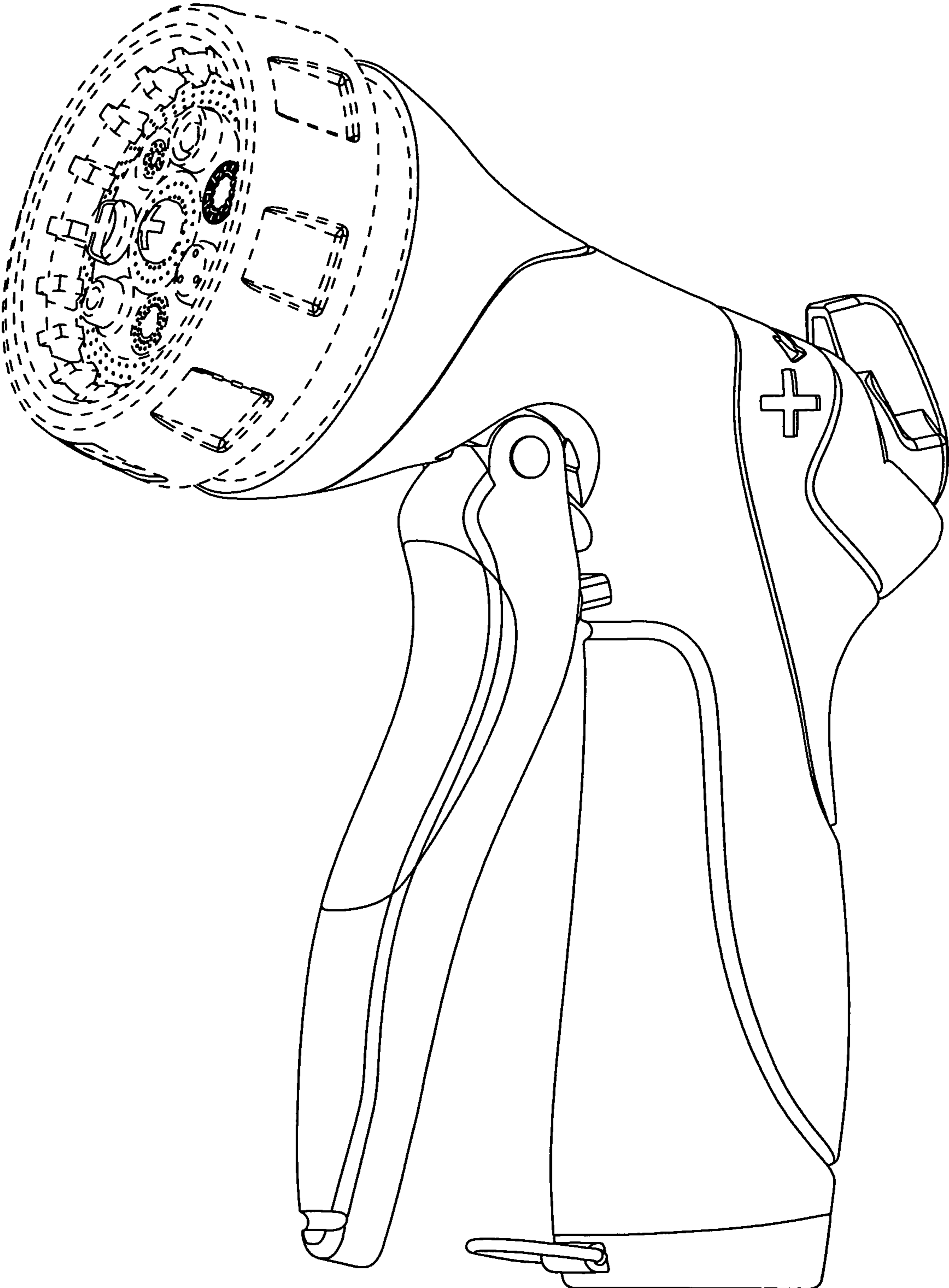

FIG 1

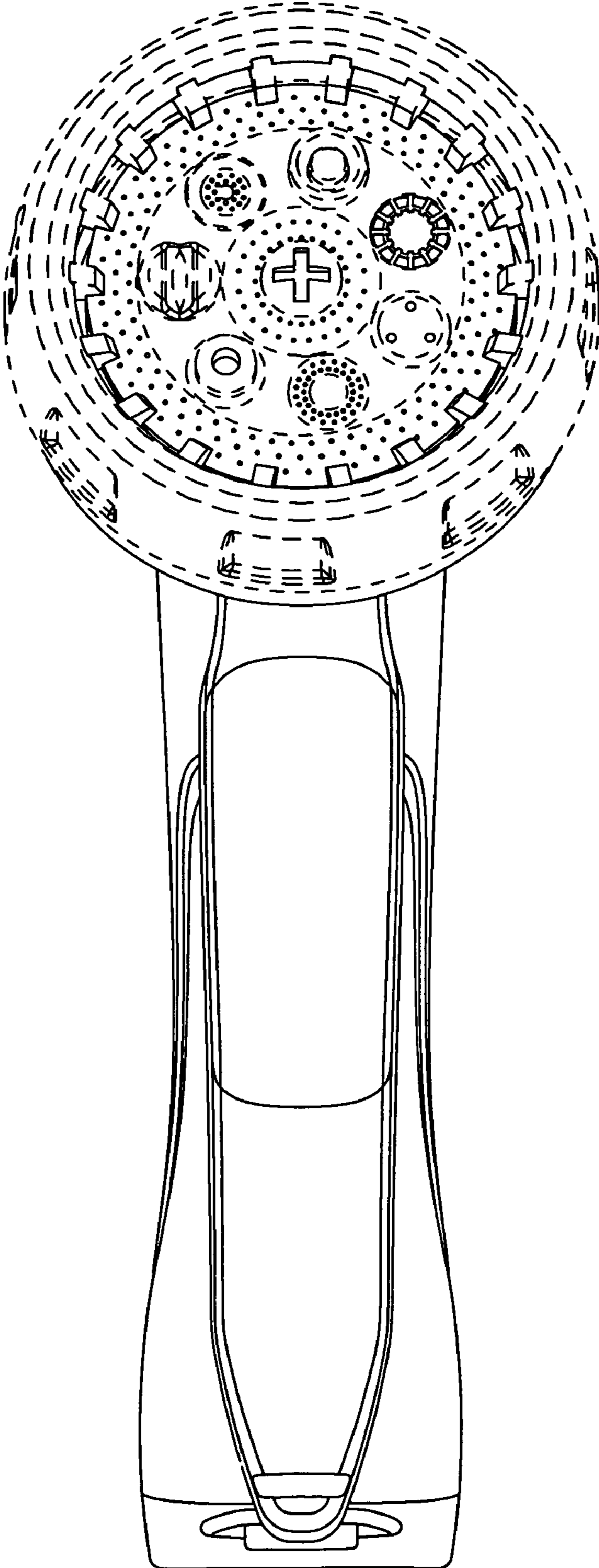

FIG 2

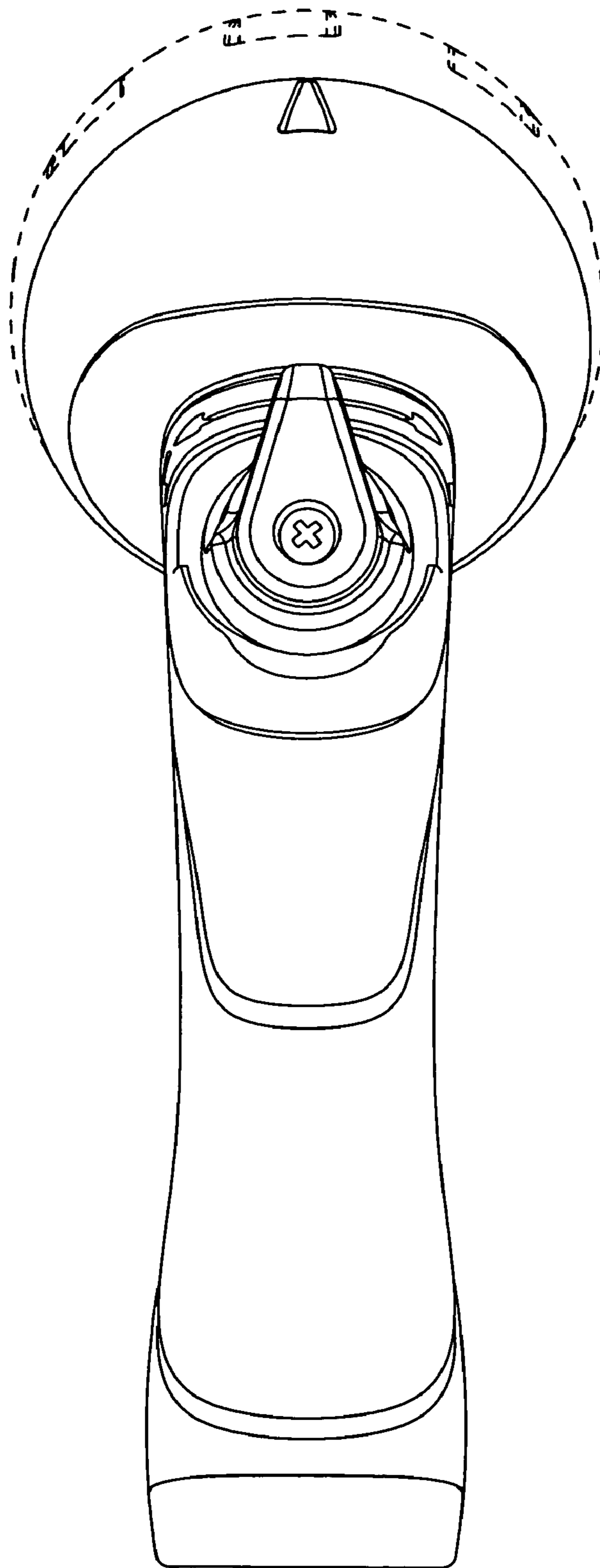

FIG 3

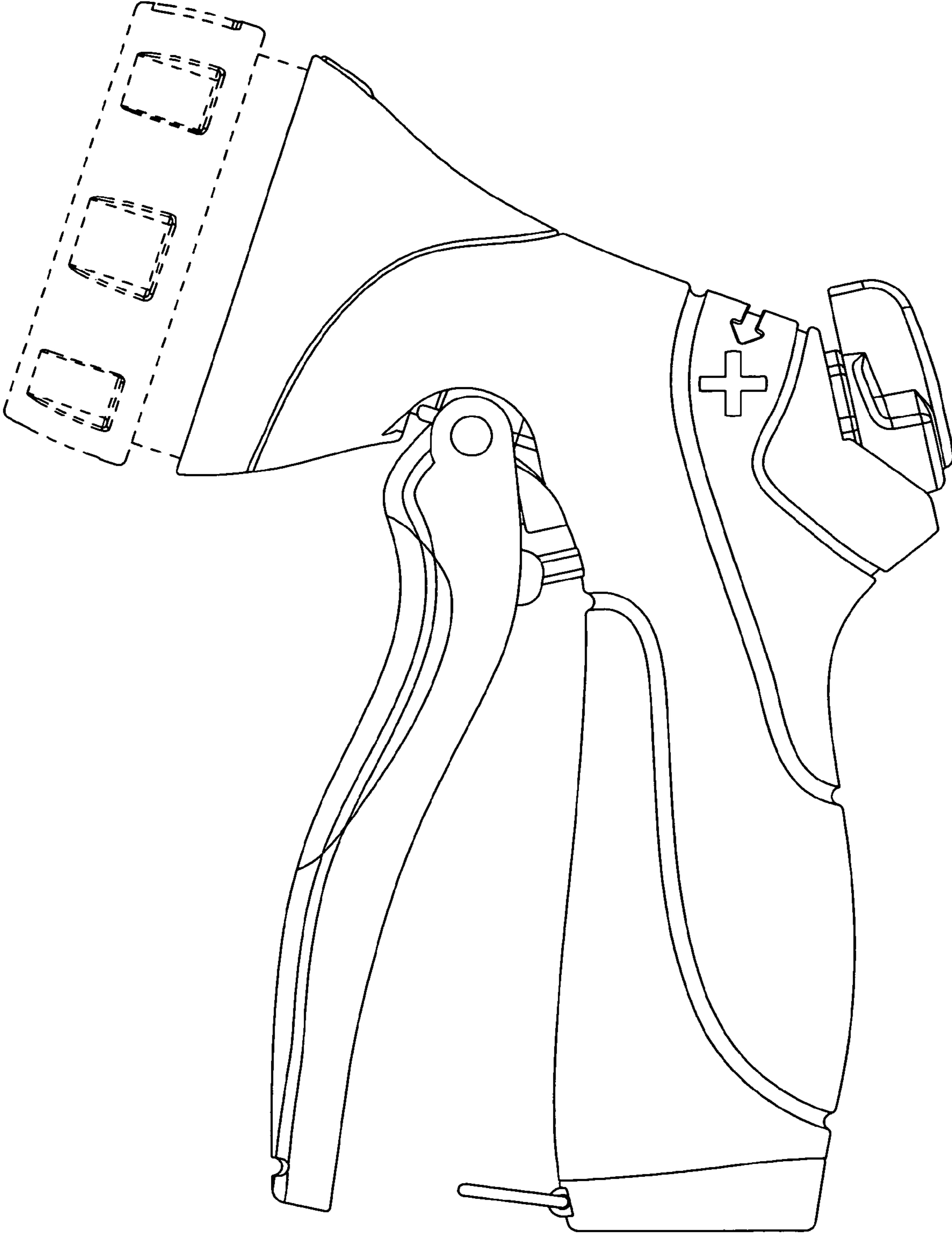

FIG 4

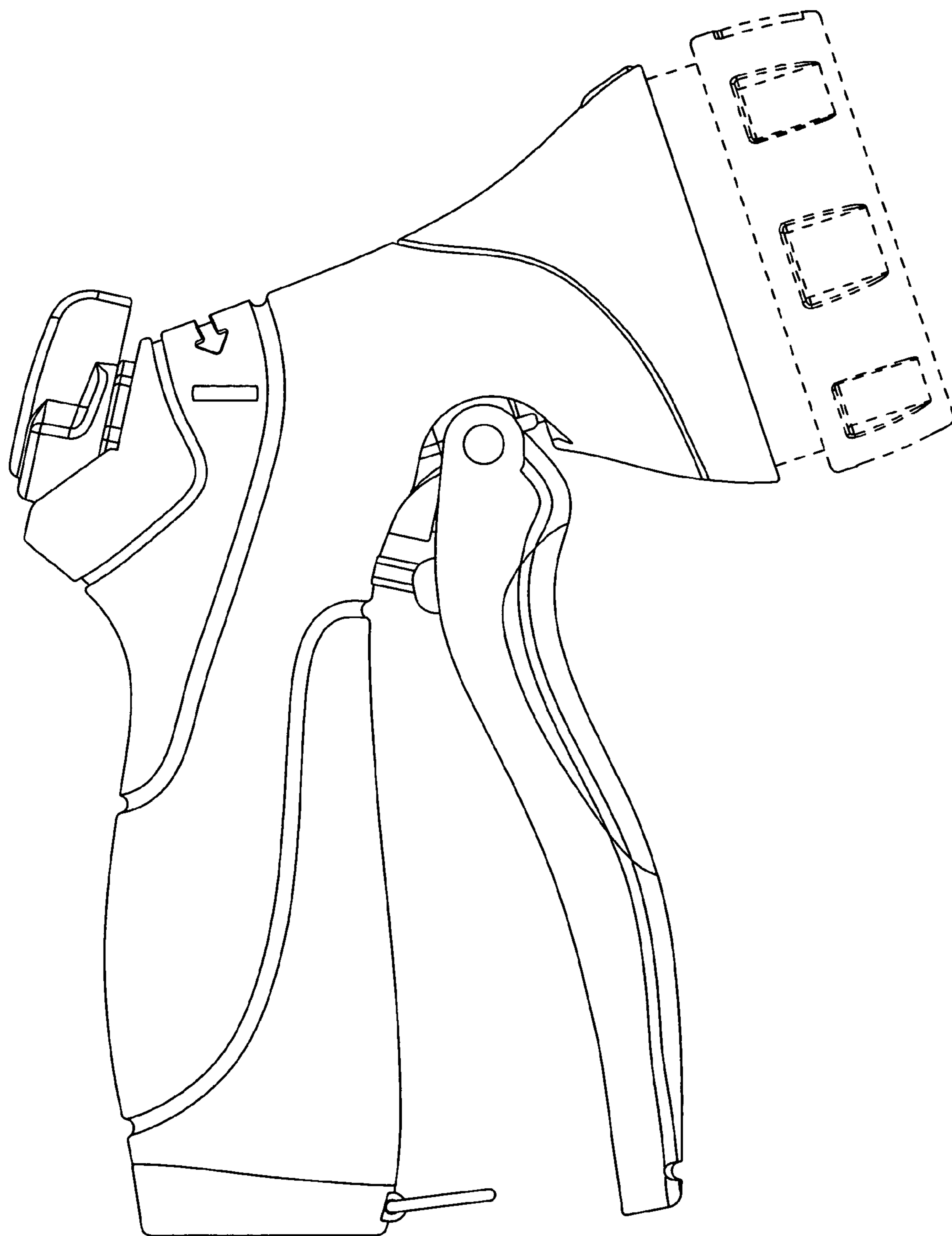

FIG 5

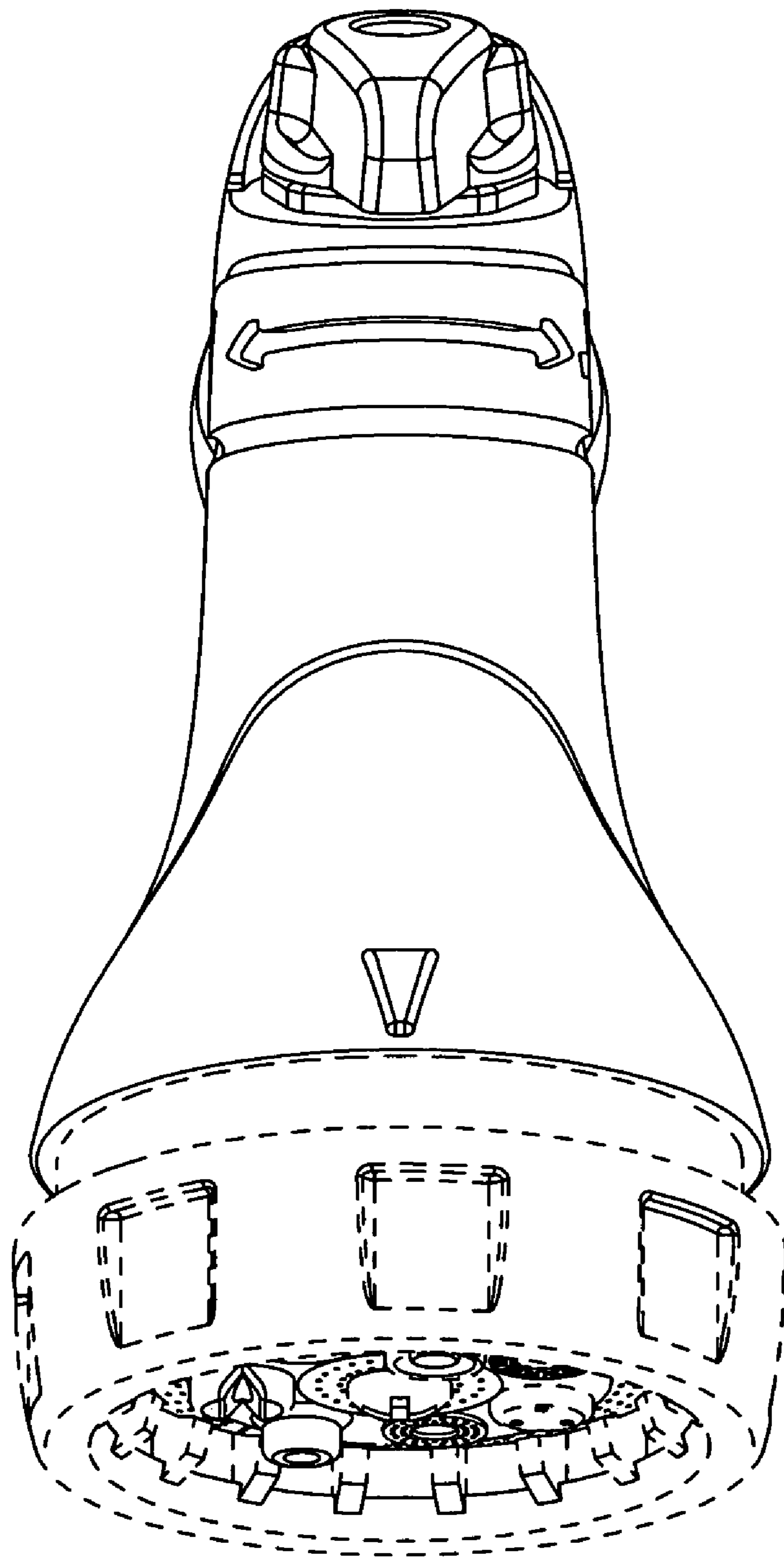

FIG 6

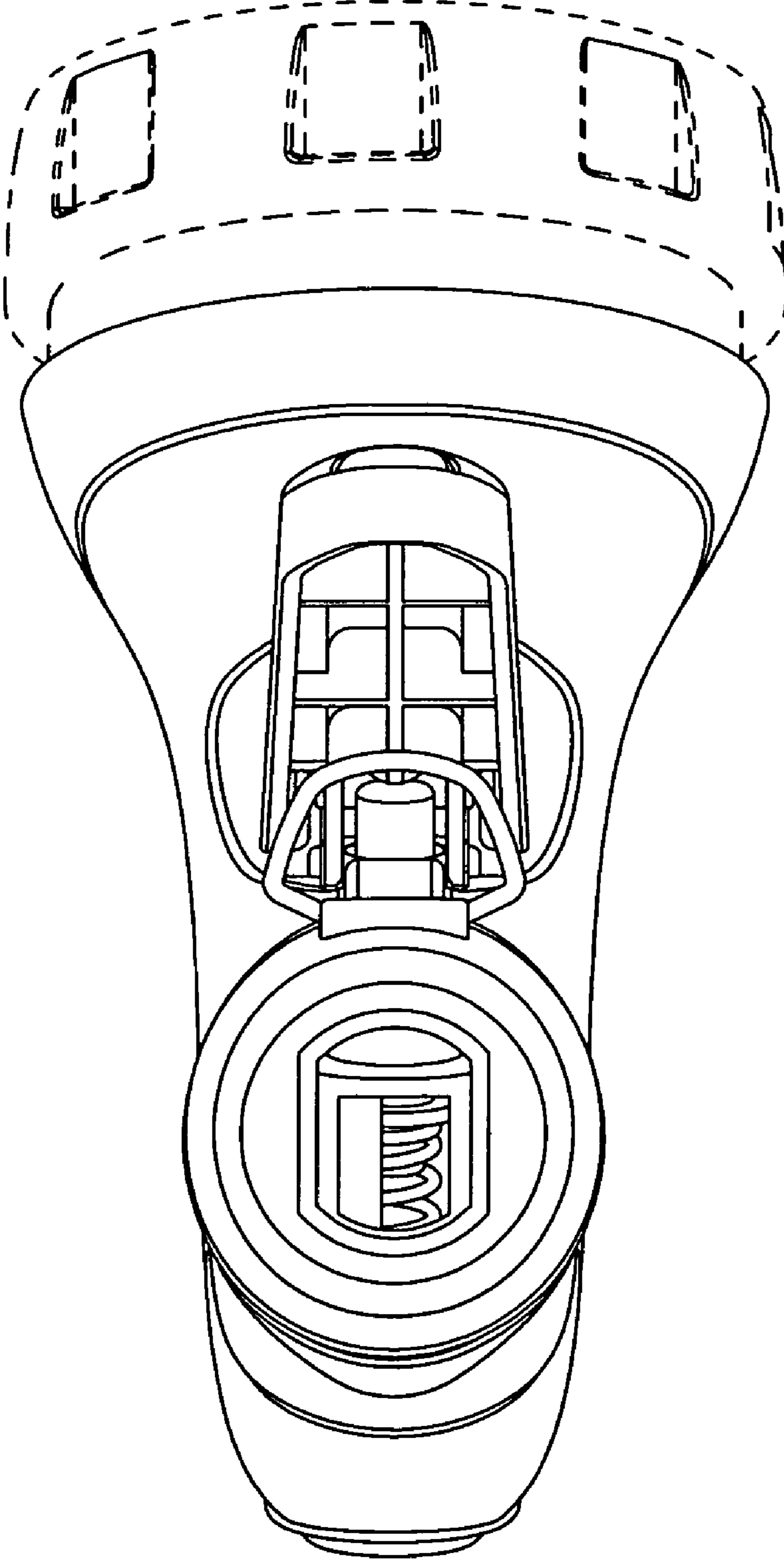

FIG 7