



US00D615429S

(12) **United States Design Patent**  
**Mendoza**

(10) **Patent No.:** **US D615,429 S**

(45) **Date of Patent:** **\*\* May 11, 2010**

(54) **TAPE MEASURE BLADE ATTACHMENT**

2004/0060188 A1\* 4/2004 Cubbedge ..... 33/770

\* cited by examiner

(76) Inventor: **Albert J. F. Mendoza**, 91-05 109th St.,  
Richmond Hill, NY (US) 11418

*Primary Examiner*—Antoine D Davis

(74) *Attorney, Agent, or Firm*—Crossley Patent Law; Mark A.  
Crossley

(\*\*) Term: **14 Years**

(21) Appl. No.: **29/346,088**

(57) **CLAIM**

(22) Filed: **Oct. 27, 2009**

The ornamental design for a tape measure blade attachment,  
as shown and described.

(51) **LOC (9) Cl.** ..... **10-04**

(52) **U.S. Cl.** ..... **D10/74**

(58) **Field of Classification Search** ..... D10/72,  
D10/74; D8/394–395; 33/768–770

See application file for complete search history.

**DESCRIPTION**

FIG. 1 is a front elevation view of a tape measure blade attachment showing my new design;

FIG. 2 is a rear elevation view thereof;

FIG. 3 is a left elevation view thereof;

FIG. 4 is a right elevation view thereof;

FIG. 5 is a top plan view thereof;

FIG. 6 is a bottom plan view thereof; and,

FIG. 7 is an isometric view thereof.

The broken lines shown in FIG. 7 are for illustrative purposes only and form no part of the claimed design.

(56) **References Cited**

U.S. PATENT DOCUMENTS

5,542,184	A	8/1996	Beard	
5,782,007	A *	7/1998	Harris	33/768
6,698,104	B2	3/2004	Scarborough	
6,763,603	B2	7/2004	Carrabino	
6,931,734	B2	8/2005	Elder et al.	
7,260,898	B2	8/2007	Snelson	
D556,065	S	11/2007	Jones et al.	

**1 Claim, 5 Drawing Sheets**

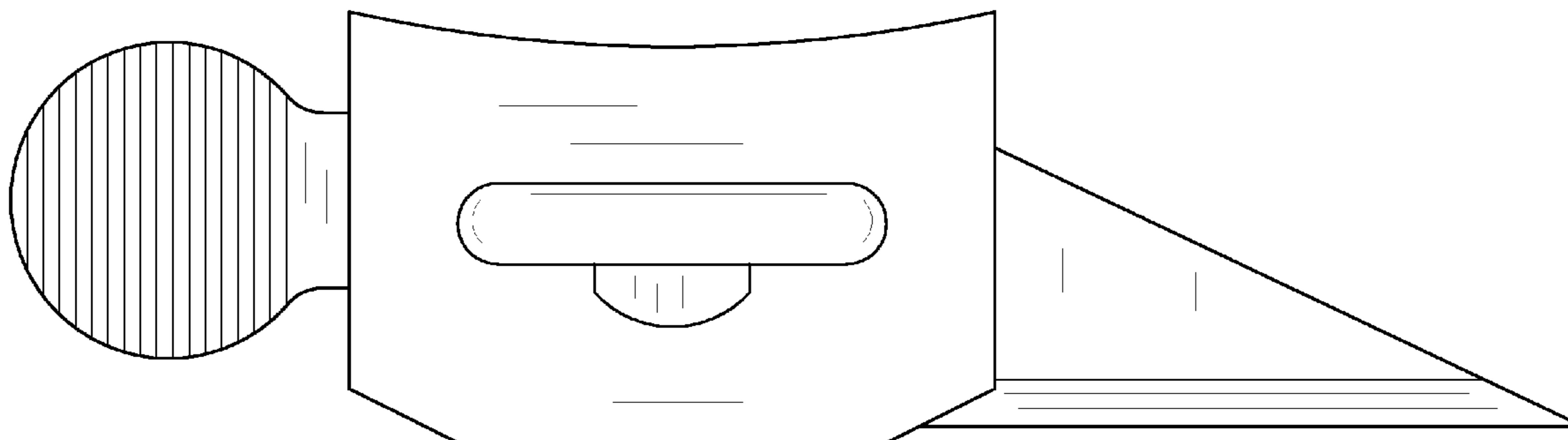

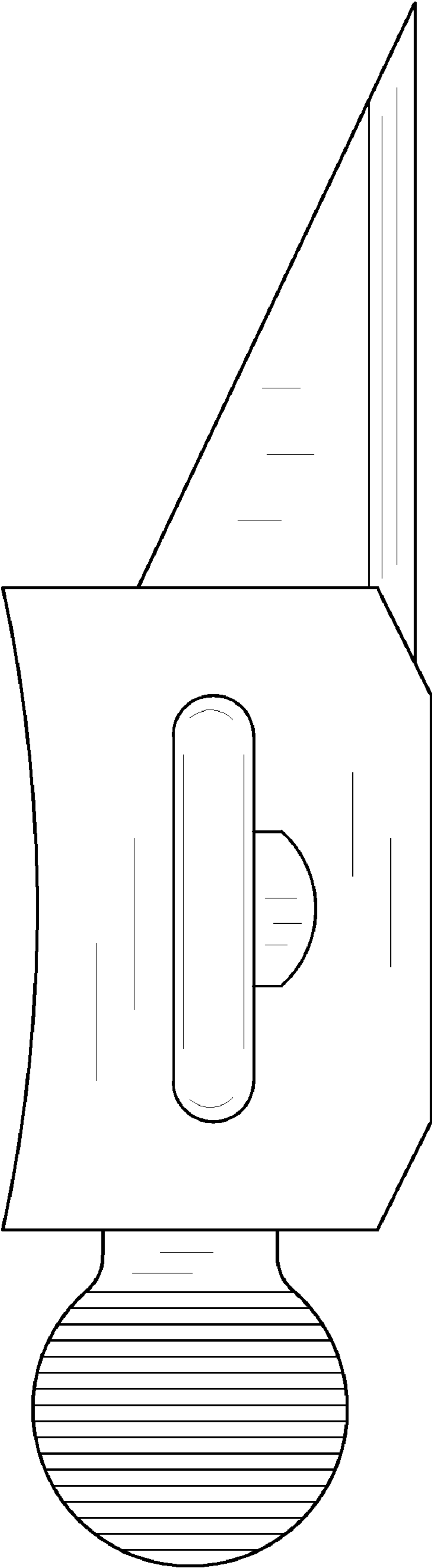

FIG. 1

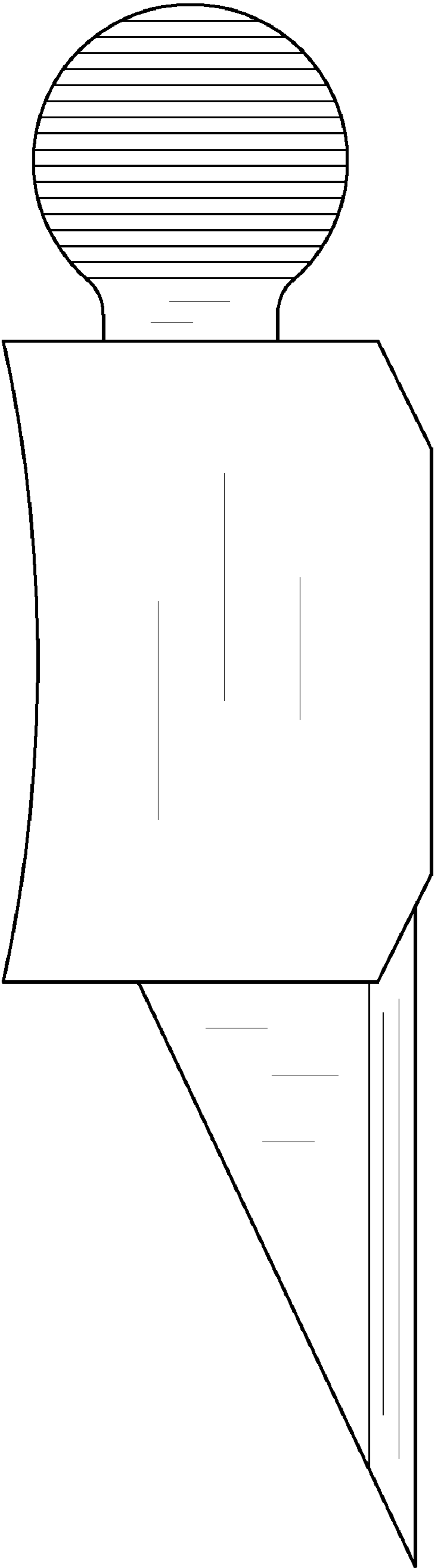

FIG. 2

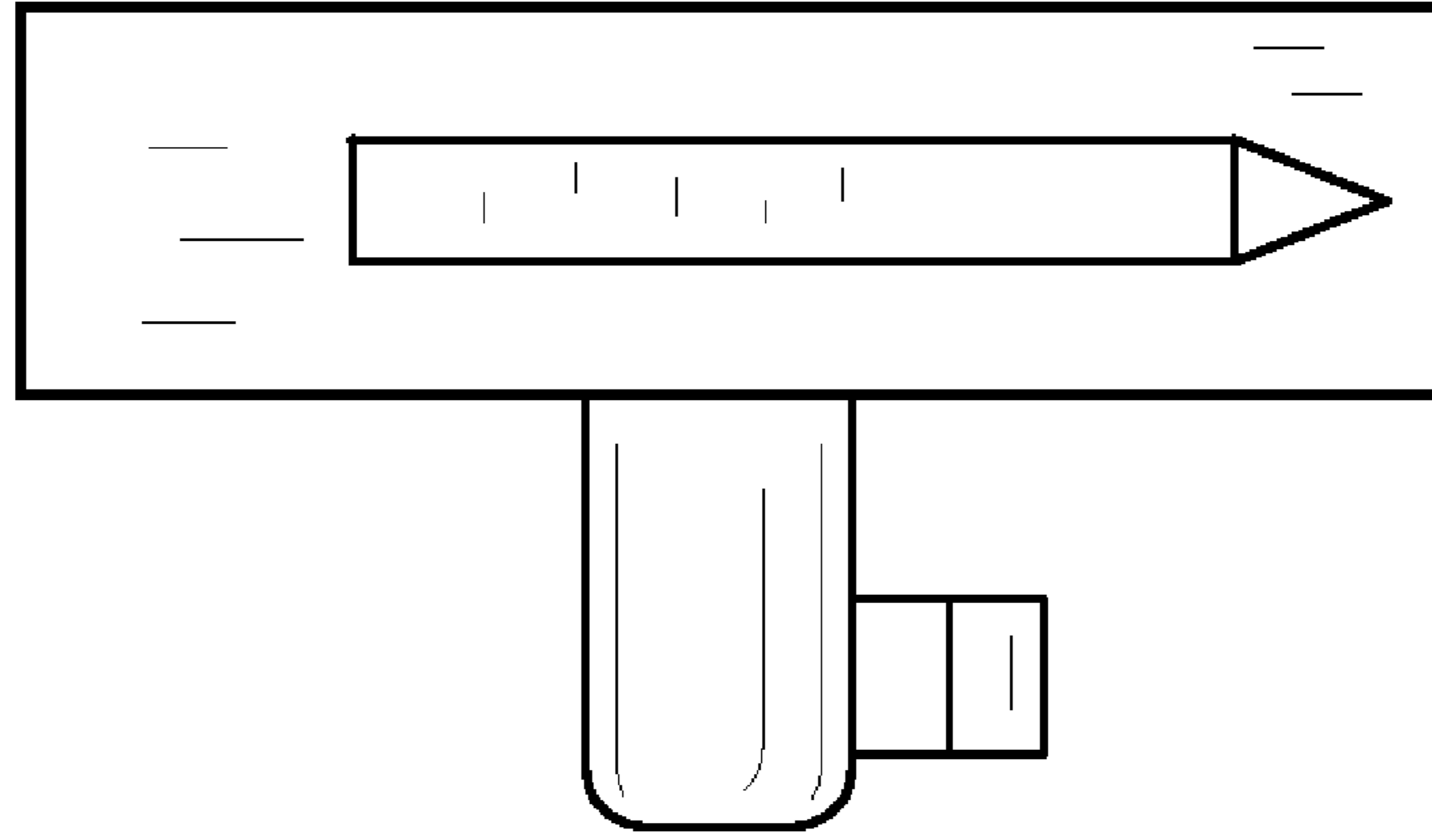

FIG. 3

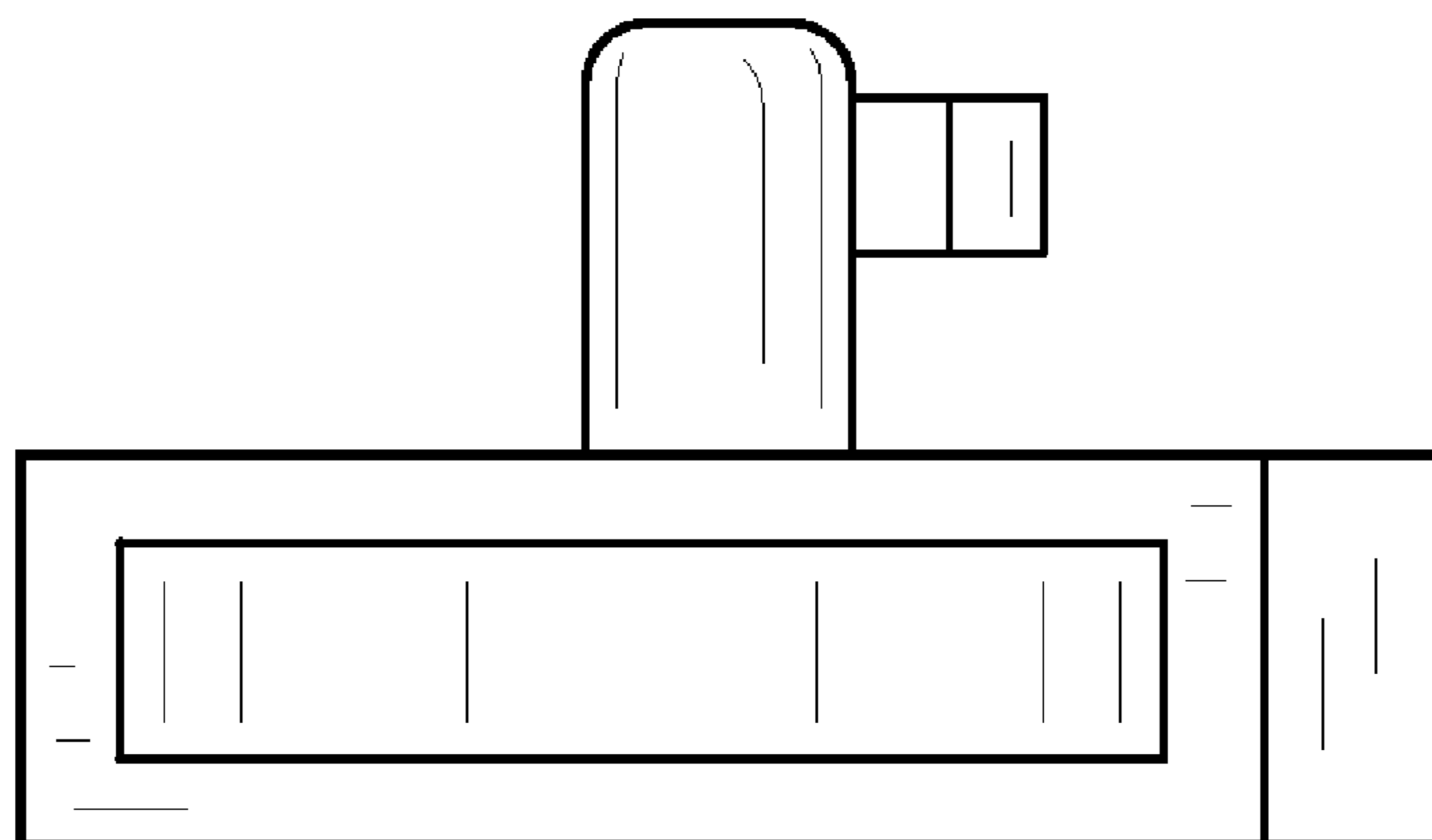

FIG. 4

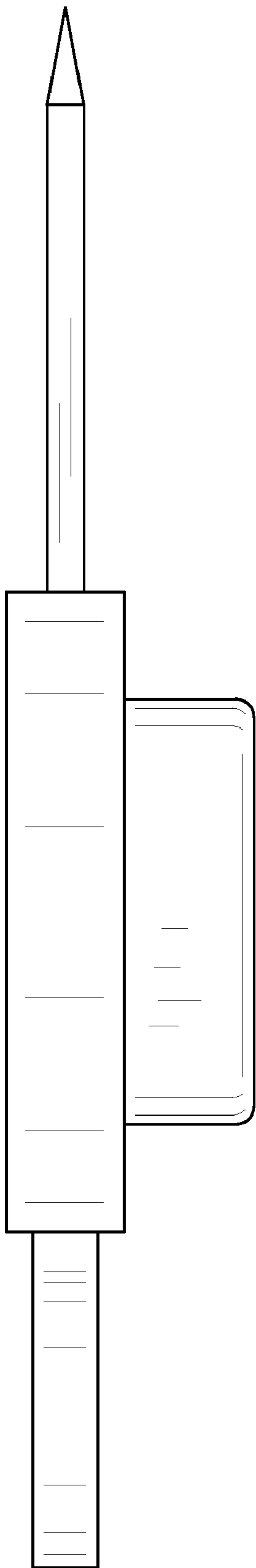

FIG. 5

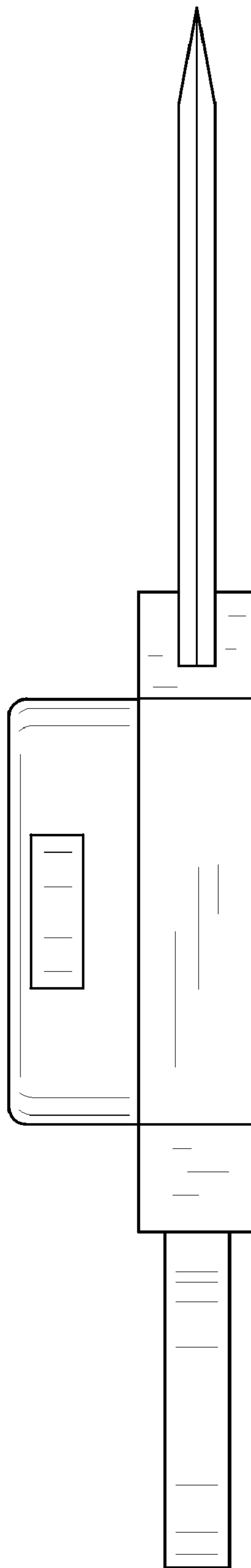

FIG. 6

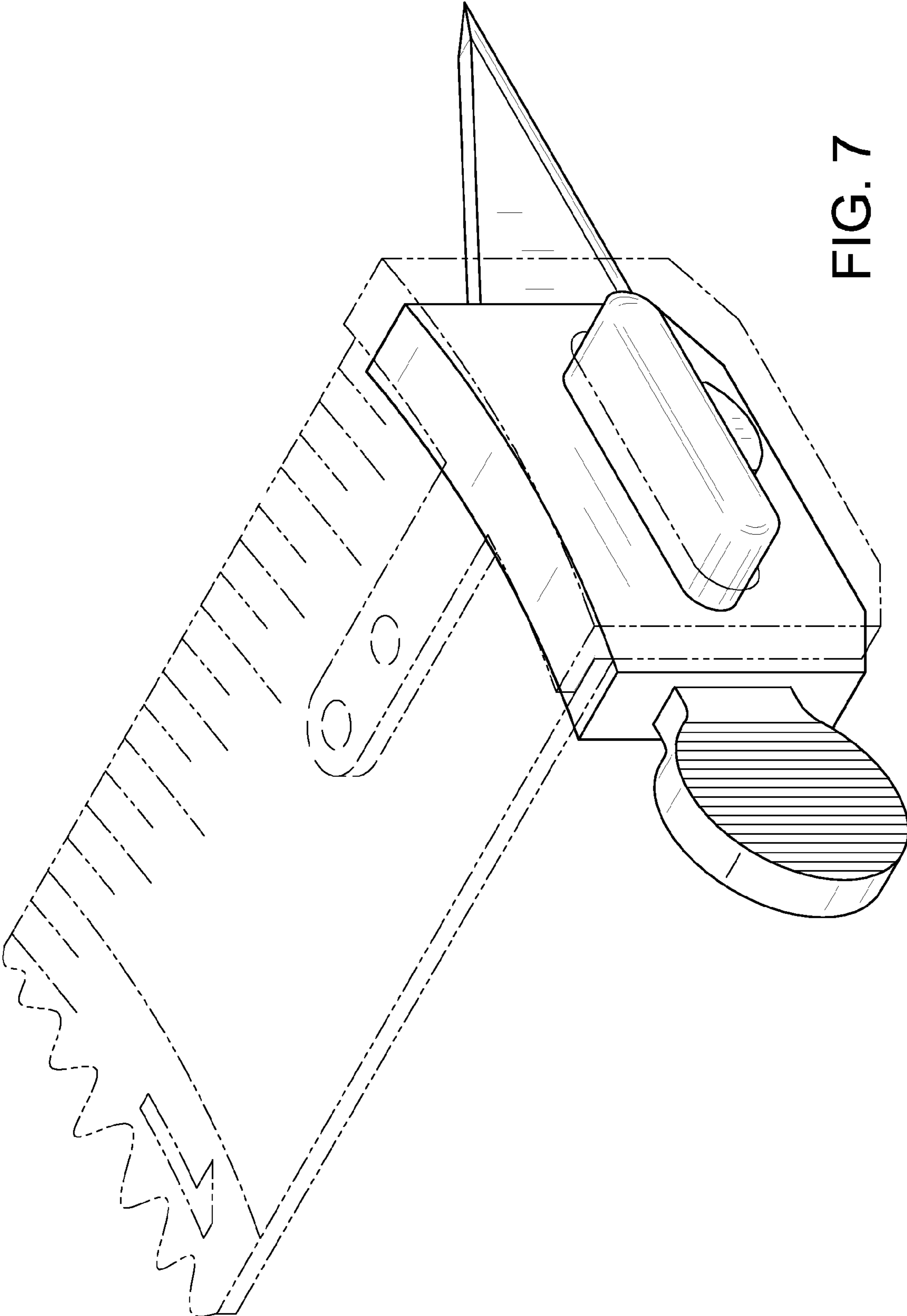

FIG. 7