



US00D615407S

(12) **United States Design Patent**  
**Shimamoto et al.**

(10) **Patent No.:** **US D615,407 S**

(45) **Date of Patent:** **\*\* May 11, 2010**

(54) **CONTAINER**

(75) Inventors: **Keiji Shimamoto**, Tokyo (JP); **Masaaki Sasaki**, Tokyo (JP); **Tadayori Nakayama**, Tokyo (JP)

(73) Assignee: **Yoshino Kogyosho Co., Ltd.**, Tokyo (JP)

(\*\*) Term: **14 Years**

(21) Appl. No.: **29/274,640**

(22) Filed: **May 11, 2007**

(51) **LOC (9) Cl.** ..... **09-01**

(52) **U.S. Cl.** ..... **D9/516; D9/543; D9/564**

(58) **Field of Classification Search** ..... D9/516,  
D9/522, 530, 537, 538, 539, 540, 541, 542,  
D9/543, 549, 551, 556, 557, 564, 569, 570,  
D9/571, 575; 215/381-385

See application file for complete search history.

(56) **References Cited**

**U.S. PATENT DOCUMENTS**

D212,410 S *	10/1968	Platte	.....	D9/531
D314,140 S *	1/1991	Kornick et al.	.....	D9/528
D357,188 S *	4/1995	Stockwell et al.	.....	D9/543
5,725,309 A *	3/1998	Robinson	.....	383/7
D399,138 S *	10/1998	Beechuk et al.	.....	D9/531
D414,116 S *	9/1999	Bourque et al.	.....	D9/531
D432,920 S *	10/2000	Johnson et al.	.....	D9/543
D454,069 S *	3/2002	Guislain	.....	D9/528
D472,151 S *	3/2003	Warren et al.	.....	D9/528
D507,746 S *	7/2005	Sasaki et al.	.....	D9/516
D525,527 S *	7/2006	Ogg	.....	D9/516
D525,528 S *	7/2006	Lane et al.	.....	D9/516
D528,421 S *	9/2006	Sasaki et al.	.....	D9/516
D529,385 S *	10/2006	Gamber et al.	.....	D9/516
D533,782 S *	12/2006	Ogg et al.	.....	D9/516

D557,141 S *	12/2007	Pedmo et al.	.....	D9/541
D565,962 S *	4/2008	Sasaki et al.	.....	D9/567
D569,257 S *	5/2008	Yourist et al.	.....	D9/516
D576,493 S *	9/2008	Coley et al.	.....	D9/516
D590,261 S *	4/2009	Howes	.....	D9/523
D592,959 S *	5/2009	Caldwell	.....	D9/523
D595,579 S *	7/2009	Feen	.....	D9/516

\* cited by examiner

*Primary Examiner*—Stella M Reid

*Assistant Examiner*—Elizabeth J Oswecki

(74) *Attorney, Agent, or Firm*—Oliff & Berridge, PLC

(57) **CLAIM**

The ornamental design for a container, as shown and described.

**DESCRIPTION**

FIG. 1 is a front view of a first embodiment of a container showing our new design;

FIG. 2 is a top view thereof;

FIG. 3 is a side view thereof, the opposite side being a mirror image;

FIG. 4 is a rear view thereof;

FIG. 5 is an enlarged perspective view thereof;

FIG. 6 is a front view of a second embodiment of a container showing our new design;

FIG. 7 is a top view thereof;

FIG. 8 is a side view thereof, the opposite side being a mirror image;

FIG. 9 is a rear view thereof; and,

FIG. 10 is an enlarged perspective view thereof.

The broken lines are for illustrative purposes only and form no part of the claimed design.

**1 Claim, 10 Drawing Sheets**

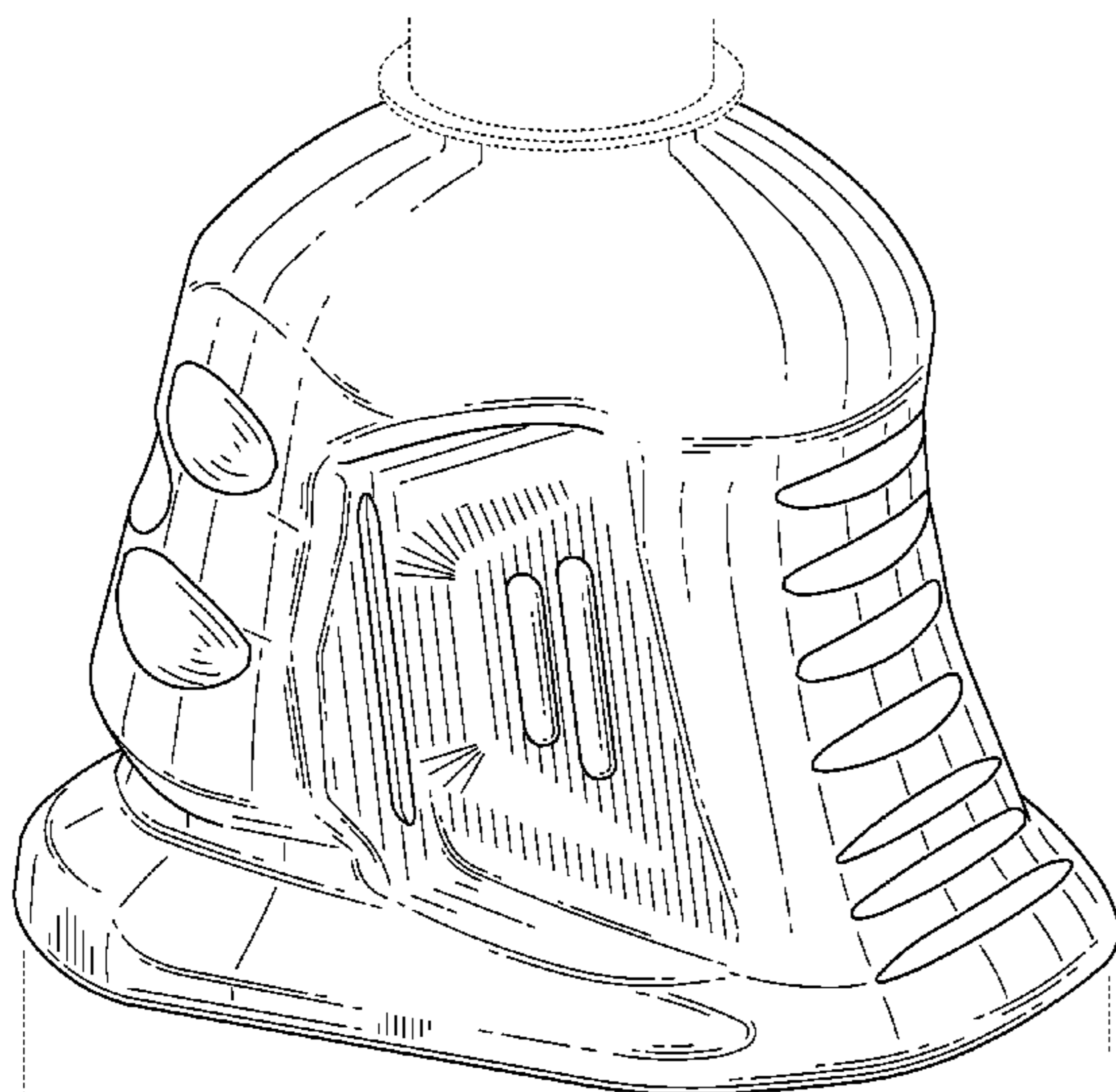

FIG. 1

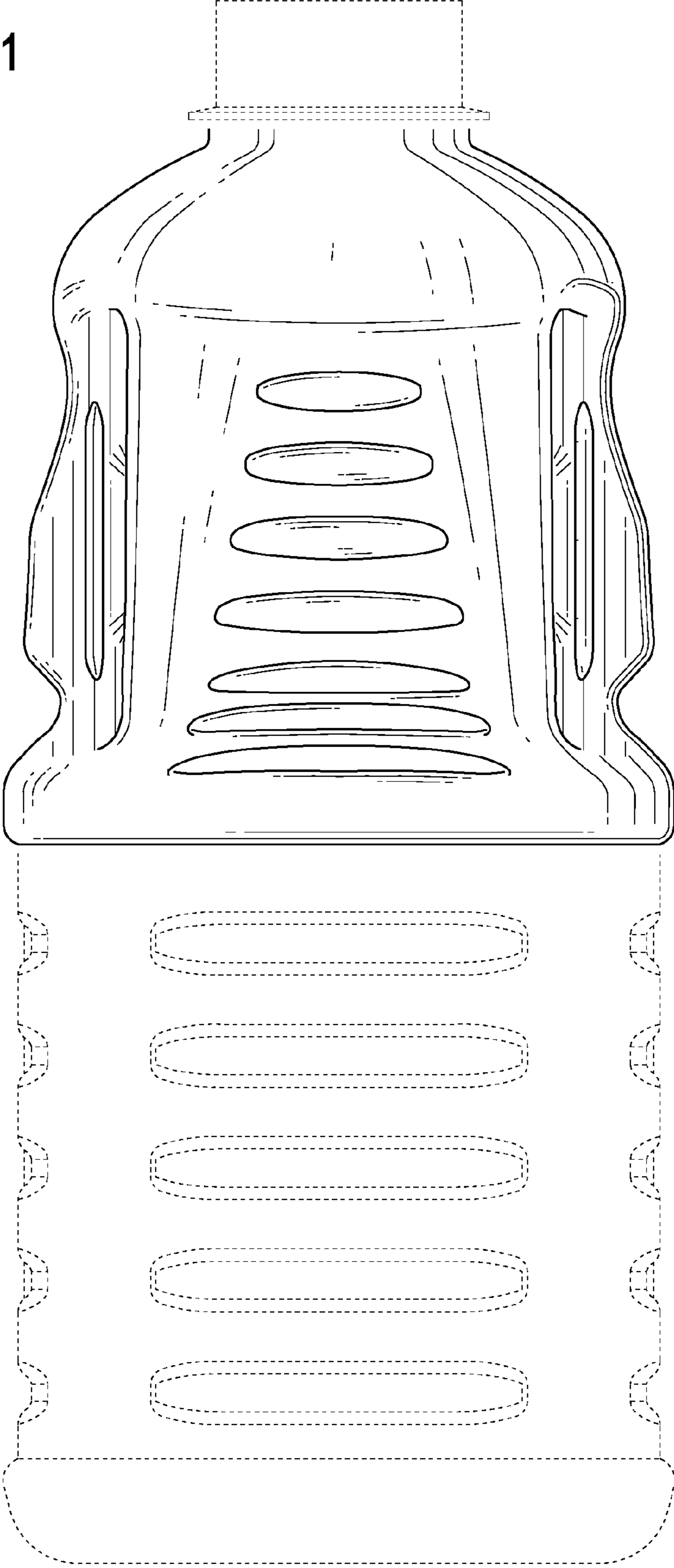

FIG. 2

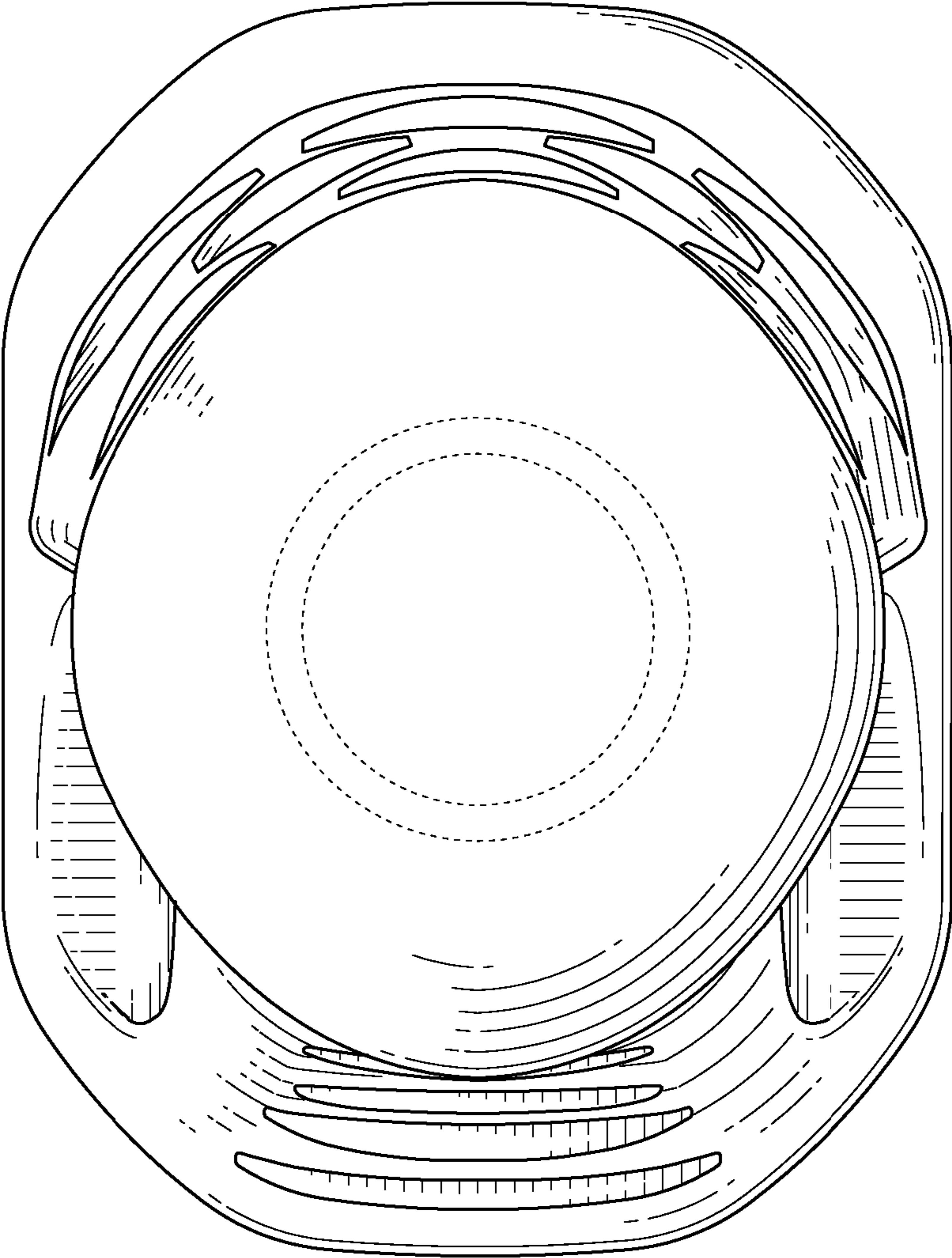

FIG. 3

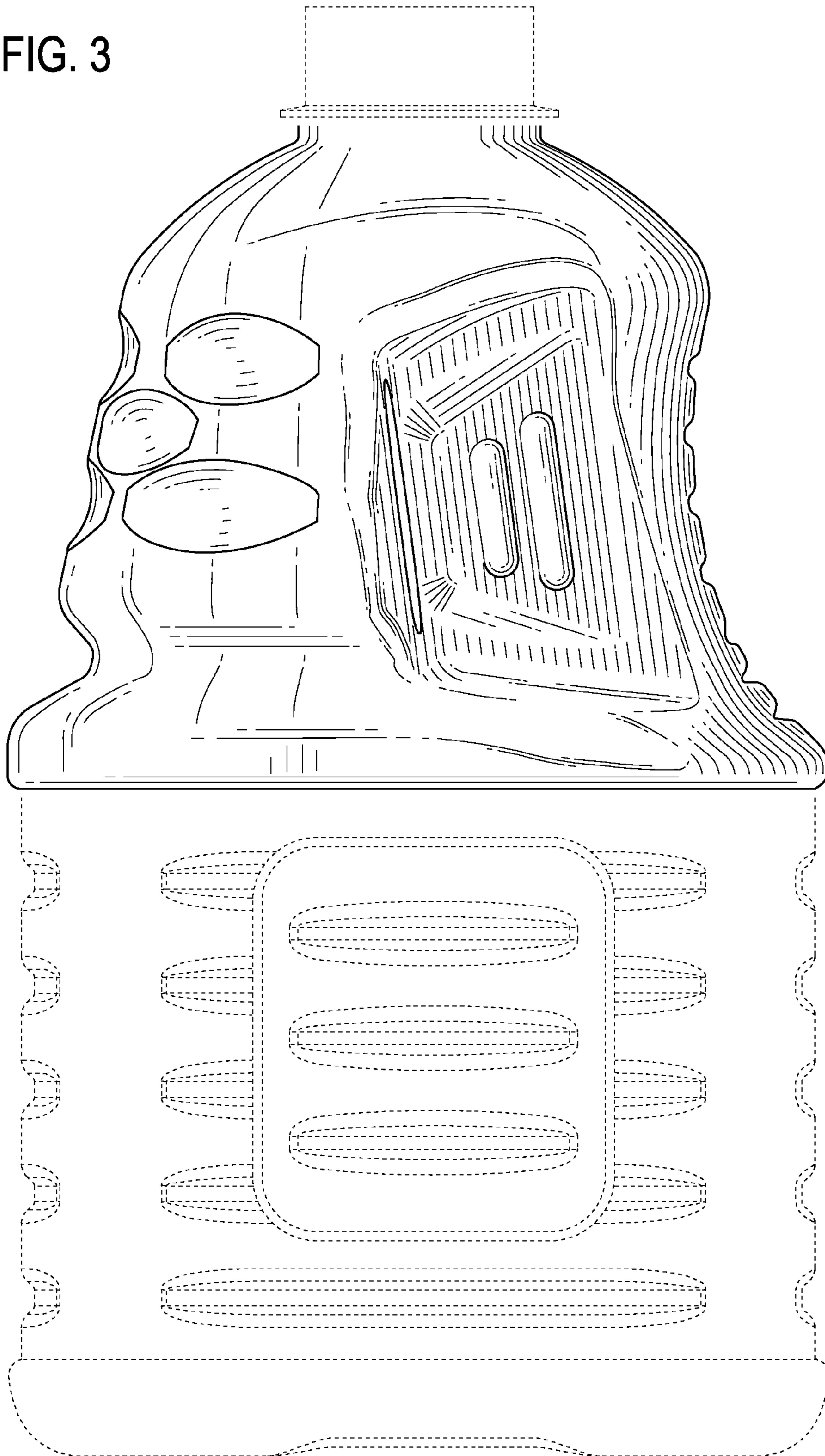

FIG. 4

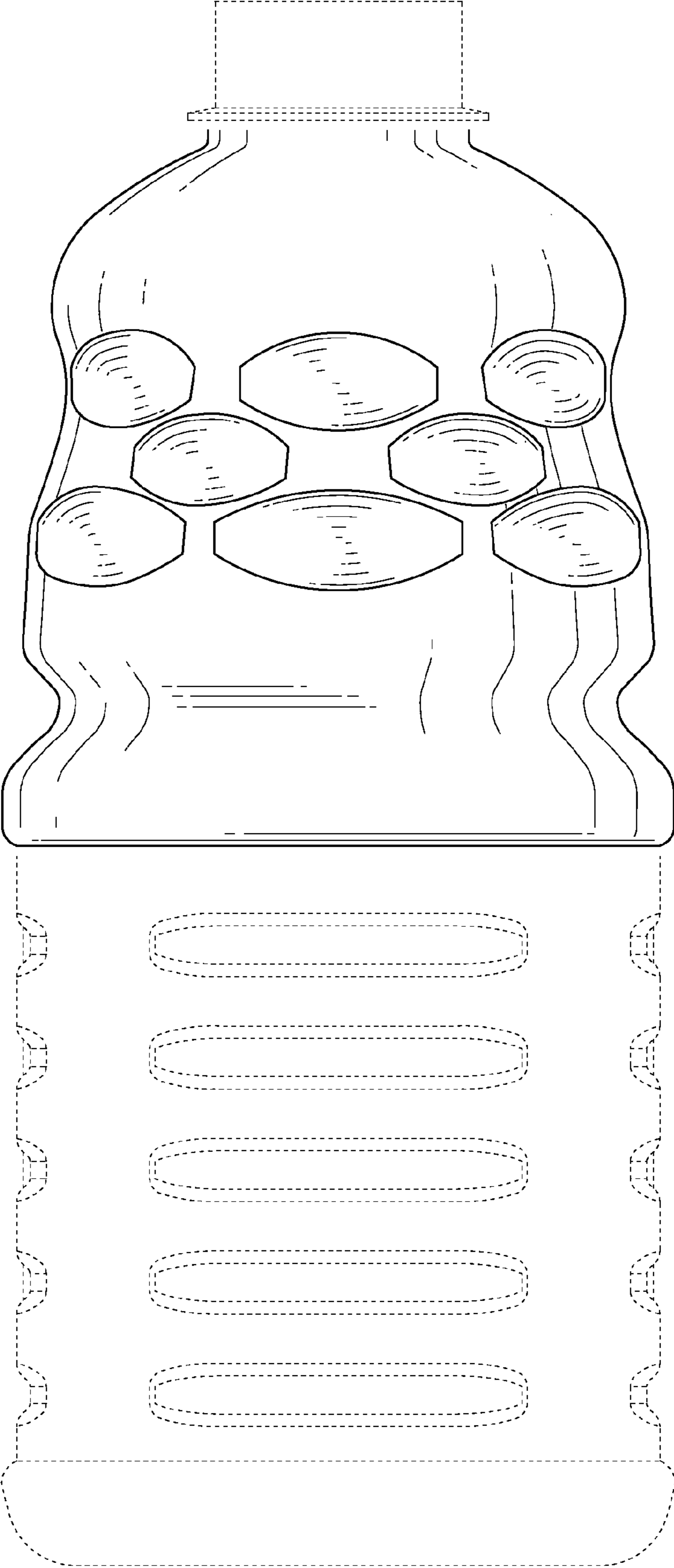

FIG. 5

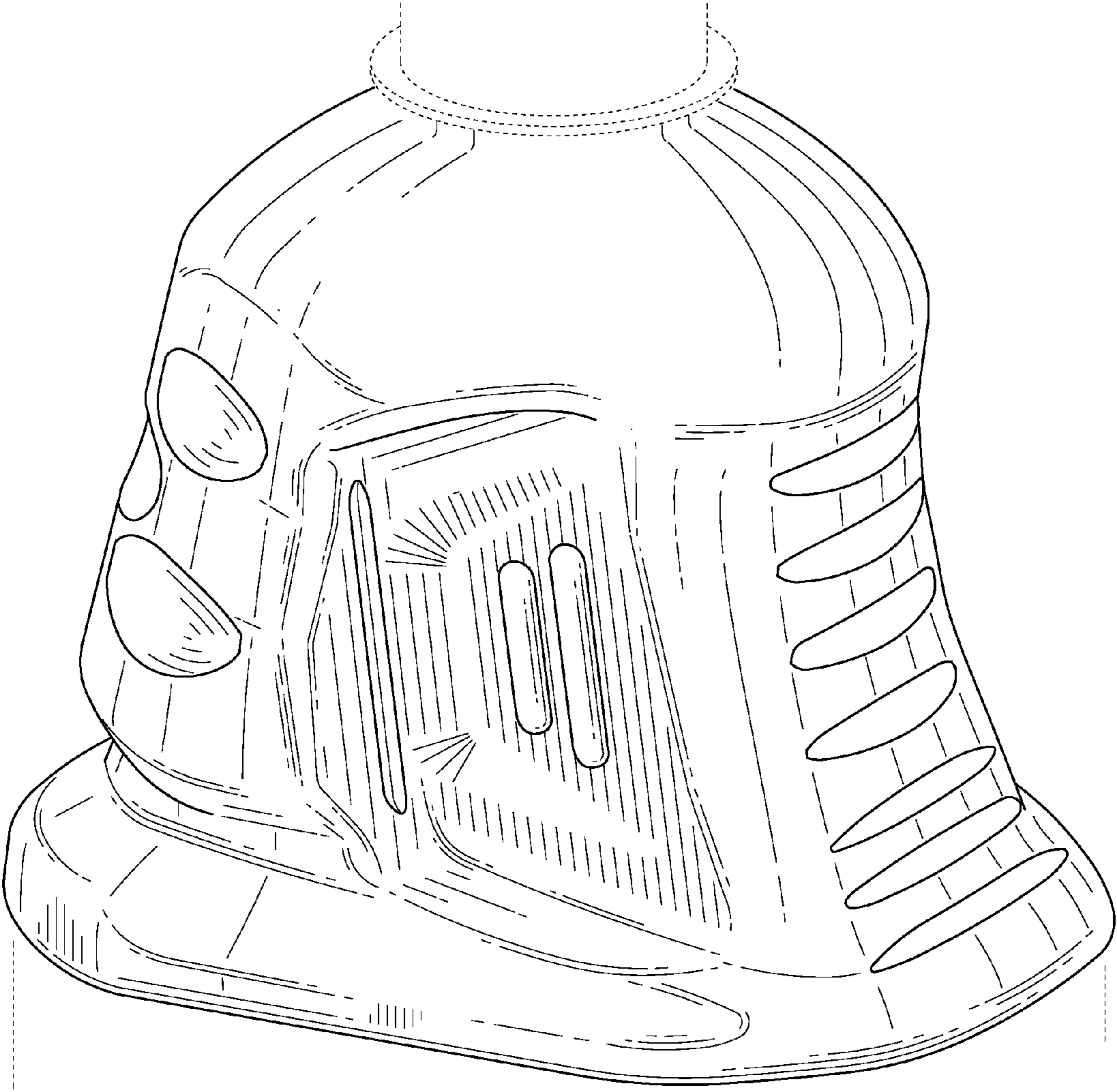

FIG. 6

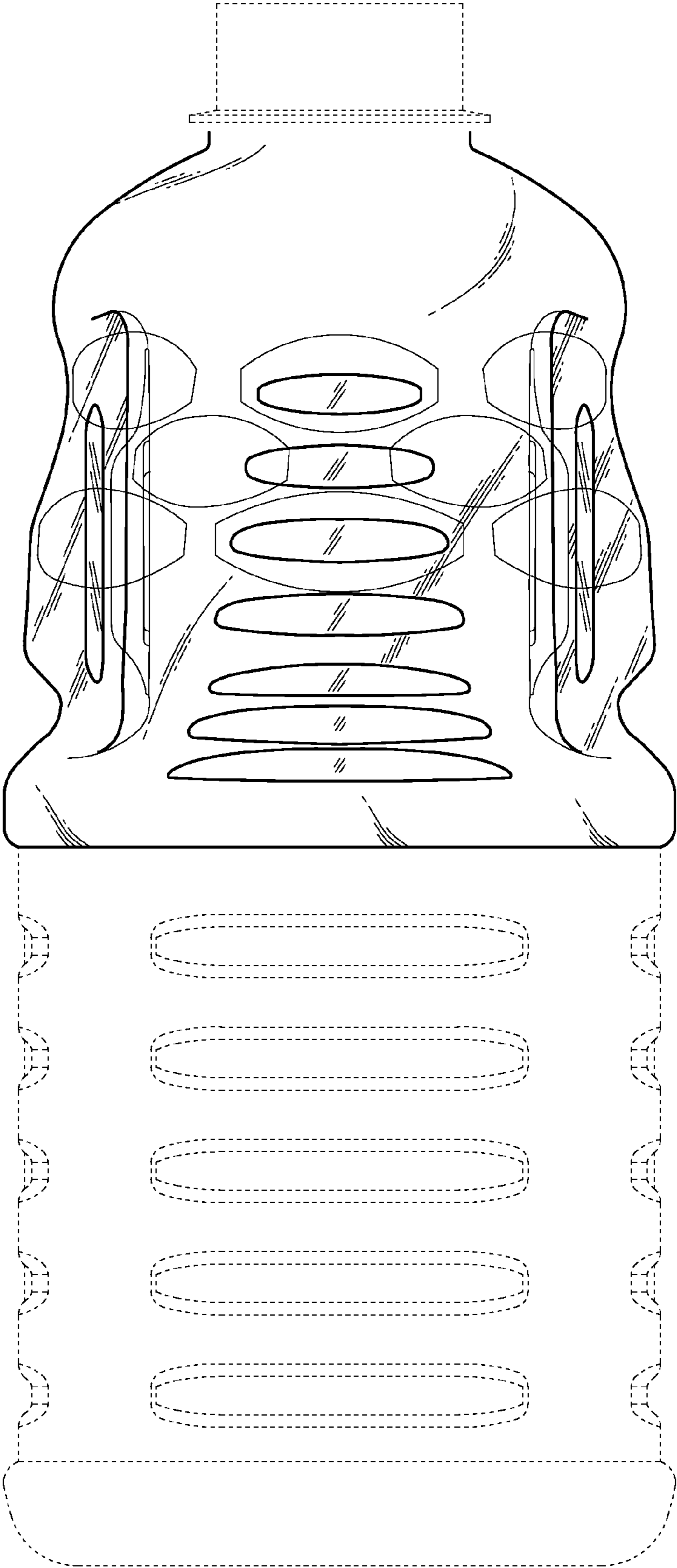

FIG. 7

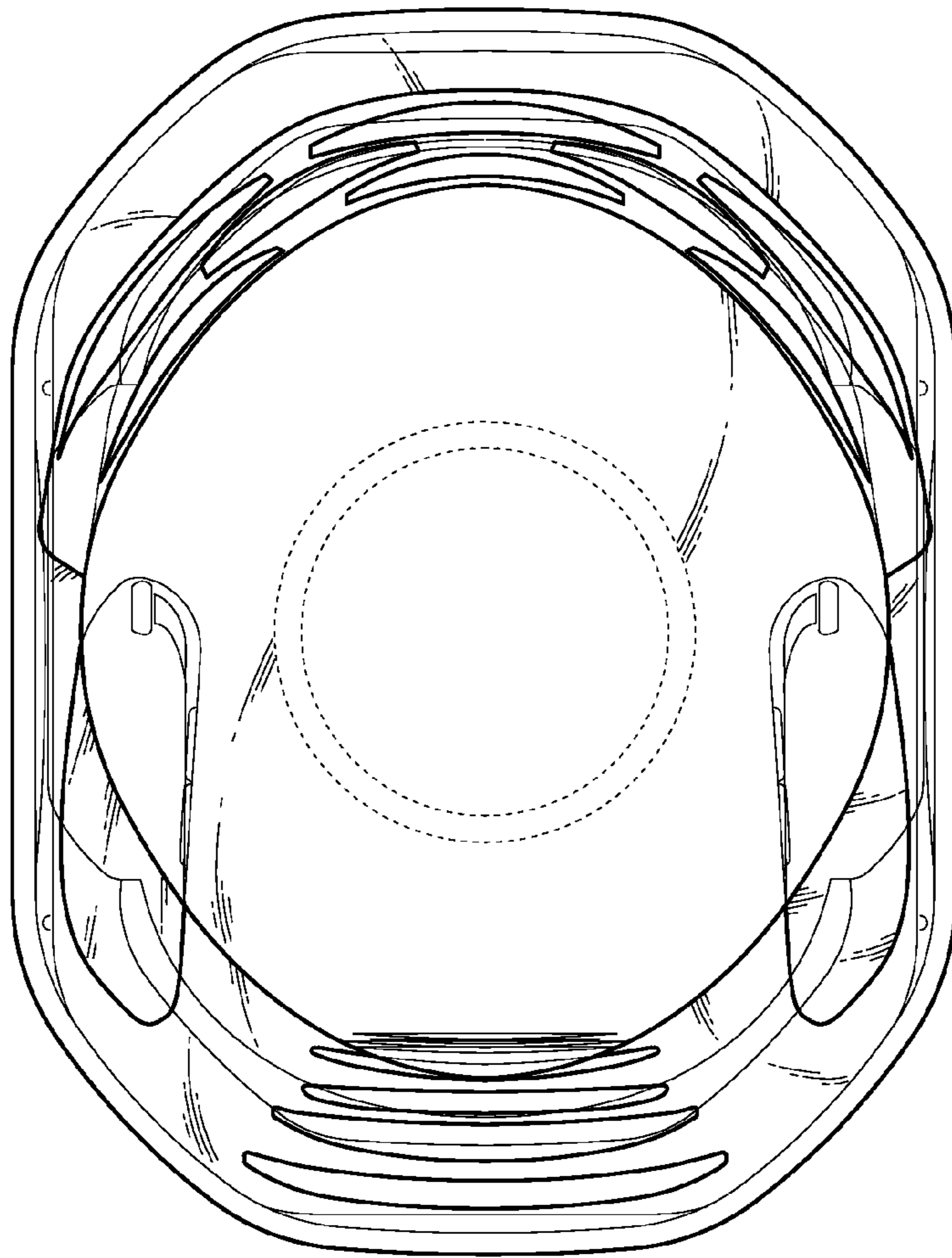



FIG. 8

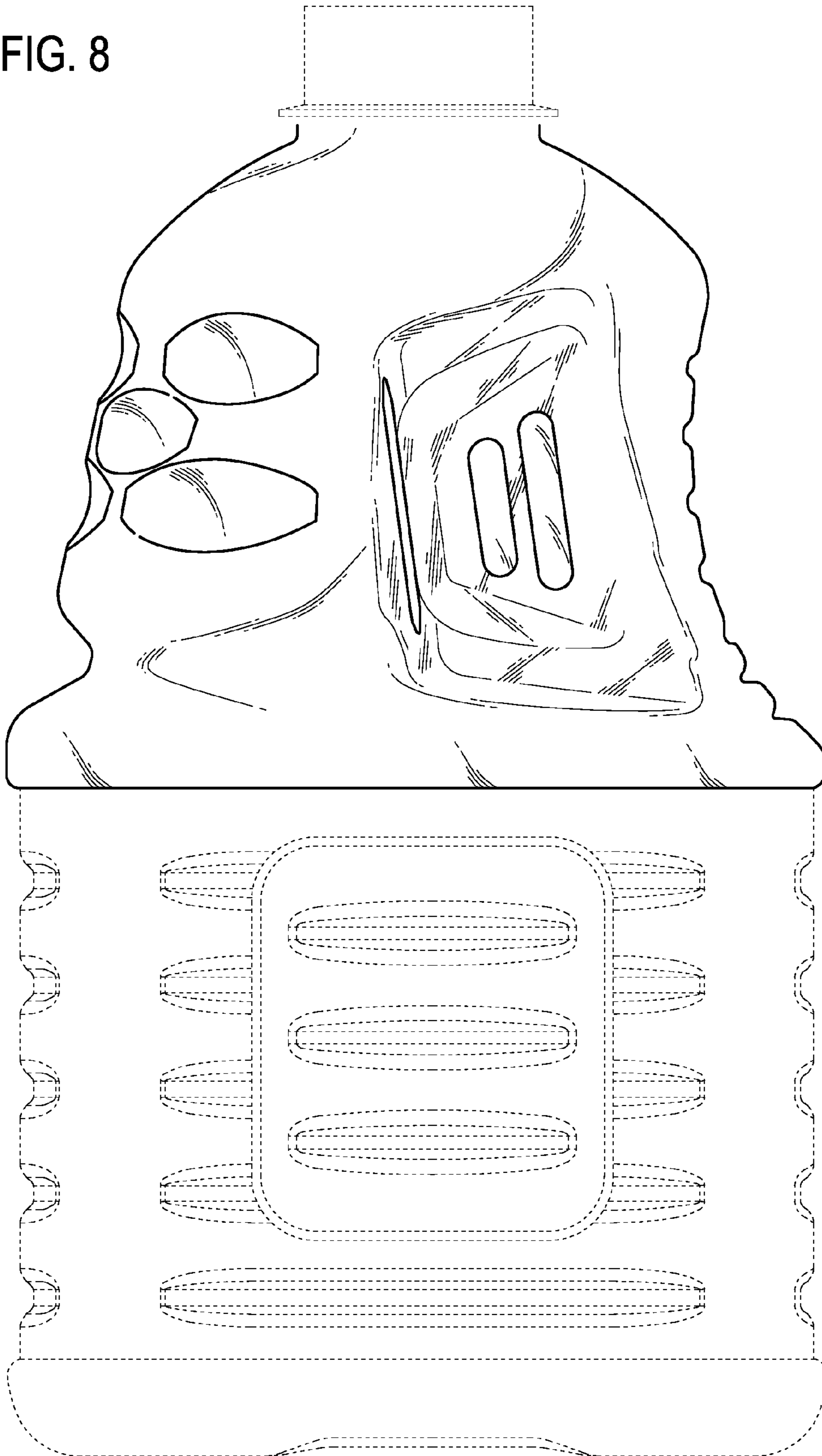

FIG. 9

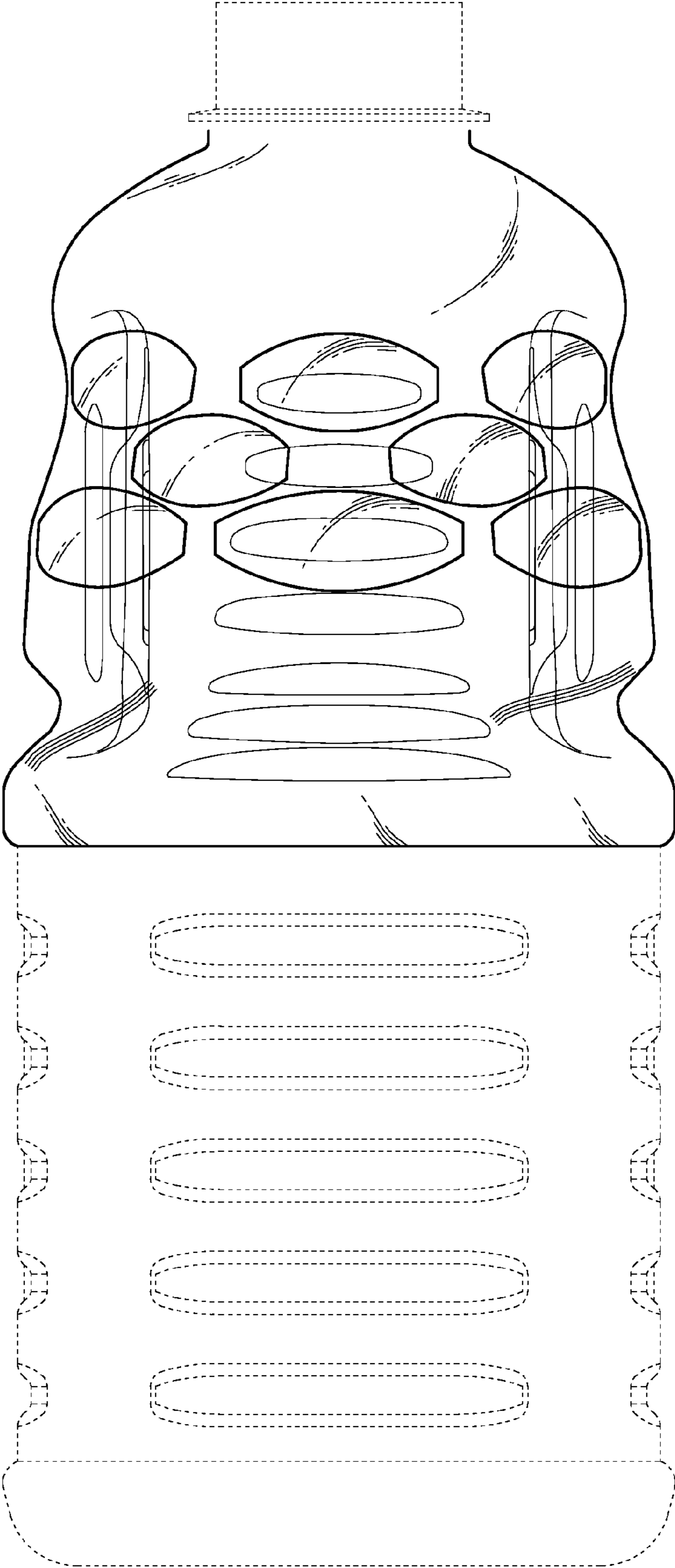

FIG. 10

