



US00D615372S

(12) **United States Design Patent**
Krus et al.

(10) **Patent No.:** **US D615,372 S**
(45) **Date of Patent:** **** May 11, 2010**

(54) **GRINDER**

D565,911 S 4/2008 Jossem et al.

(75) Inventors: **Matthew Krus**, Seattle, WA (US);
David A. Holcomb, Seattle, WA (US)

(73) Assignee: **Chef'n Corporation**, Seattle, WA (US)

(**) Term: **14 Years**

(21) Appl. No.: **29/339,839**

(22) Filed: **Jul. 8, 2009**

(51) **LOC (9) Cl.** **07-06**

(52) **U.S. Cl.** **D7/679; D7/401.1**

(58) **Field of Classification Search** D7/590-597,
D7/679, 401.1; 222/480, 142.1-142.9; 241/168,
241/169, 169.1, 273.1-273.4, 286
See application file for complete search history.

(56) **References Cited**

U.S. PATENT DOCUMENTS

D337,923 S	8/1993	Ancona et al.	
D370,160 S *	5/1996	Holcomb et al.	D7/679
D452,997 S	1/2002	Holcomb et al.	
D453,096 S	1/2002	Stewart et al.	
D464,852 S	10/2002	Tang	
6,672,524 B1 *	1/2004	Holcomb et al.	241/169
D504,278 S	4/2005	Tardif	
D565,909 S	4/2008	Krus	

OTHER PUBLICATIONS

U.S. Appl. No. 29/338,711, filed Jun. 17, 2009.
U.S. Appl. No. 29/338,712, filed Jun. 17, 2009.
U.S. Appl. No. 29/338,713, filed Jun. 17, 2009.
U.S. Appl. No. 29/338,948, filed Jun. 22, 2009.

* cited by examiner

Primary Examiner—Terry A Wallace

(74) *Attorney, Agent, or Firm*—Seed IP Law Group PLLC

(57) **CLAIM**

The ornamental design for a grinder, as shown and described.

DESCRIPTION

FIG. 1 is a front isometric view of a grinder showing our new design.

FIG. 2 is a rear elevation view thereof.

FIG. 3 is a right side elevation view thereof.

FIG. 4 is a front elevation view thereof.

FIG. 5 is a left side elevation view thereof.

FIG. 6 is a bottom plan view thereof; and,

FIG. 7 is a top plan view thereof.

The broken lines in the figures are for illustrative purposes only and form no part of the claimed design.

1 Claim, 6 Drawing Sheets

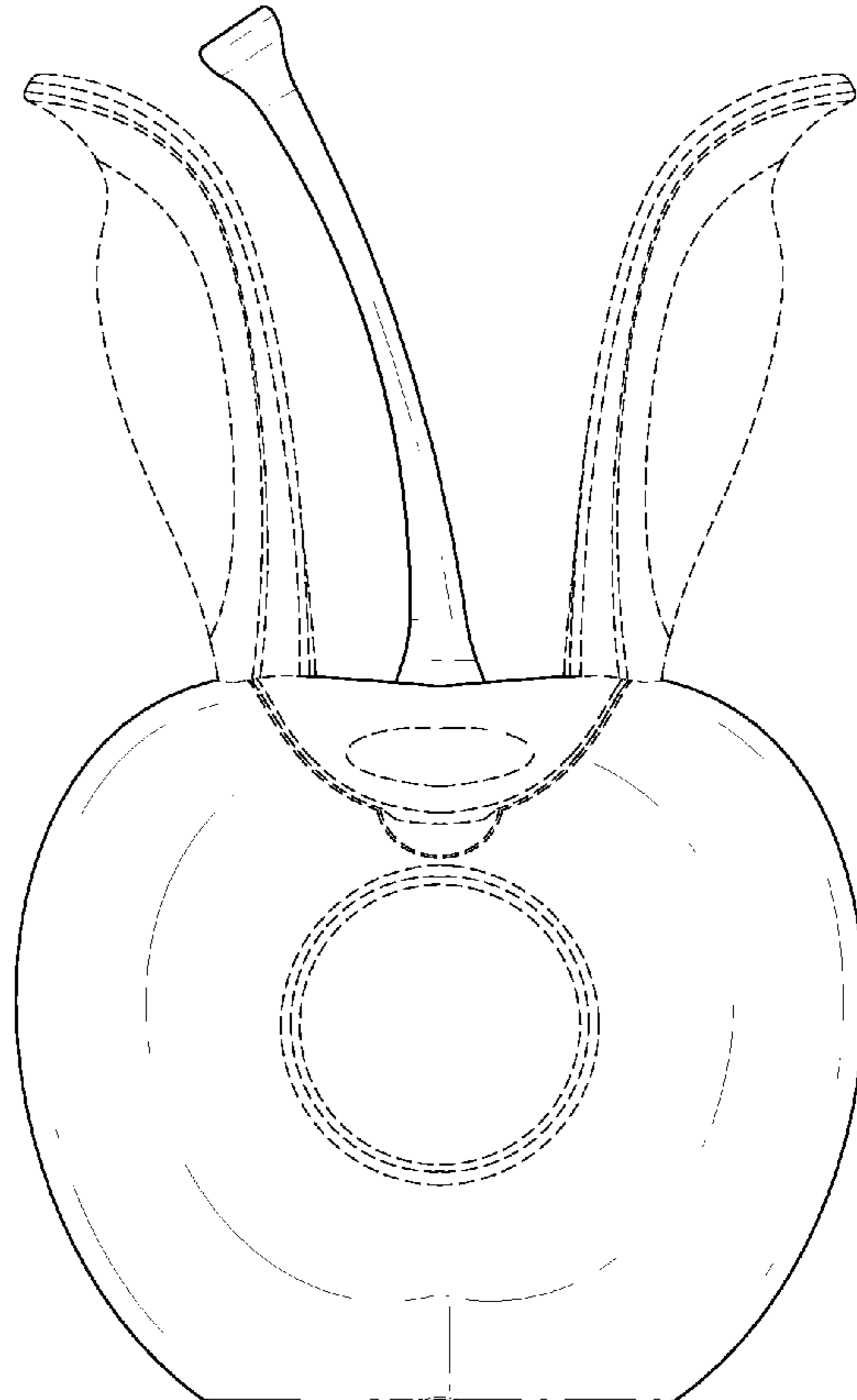
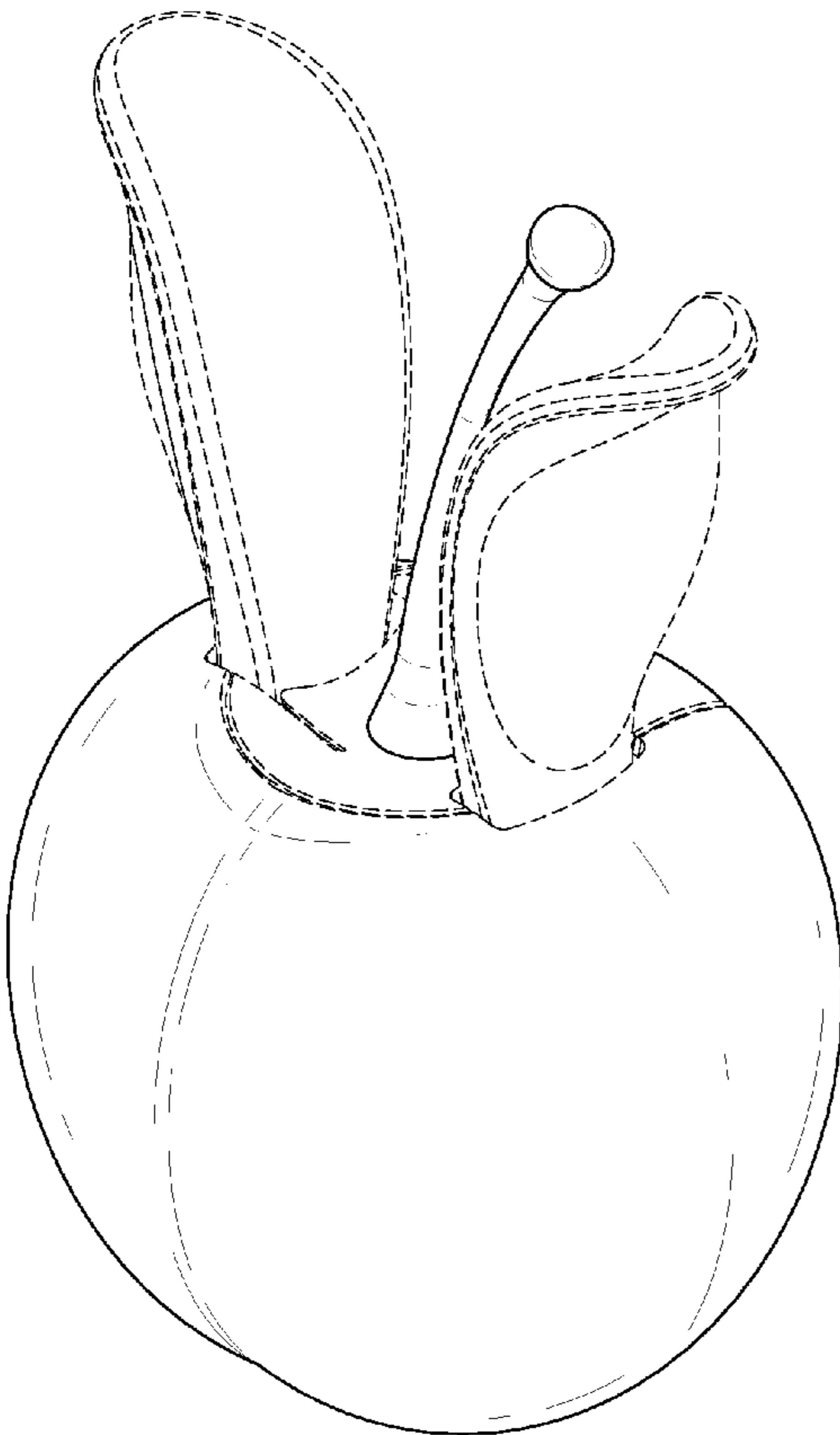

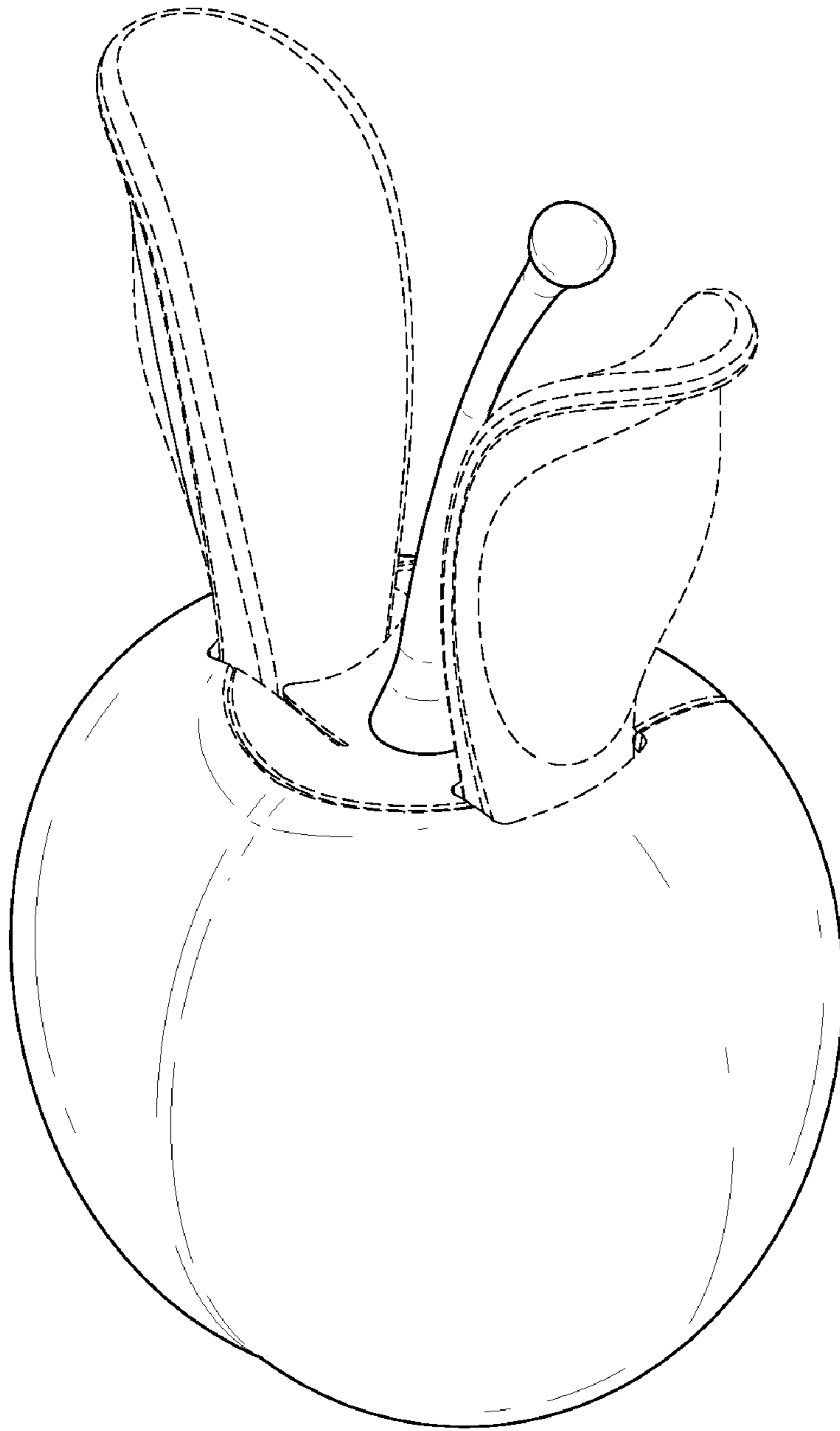

FIG. 1

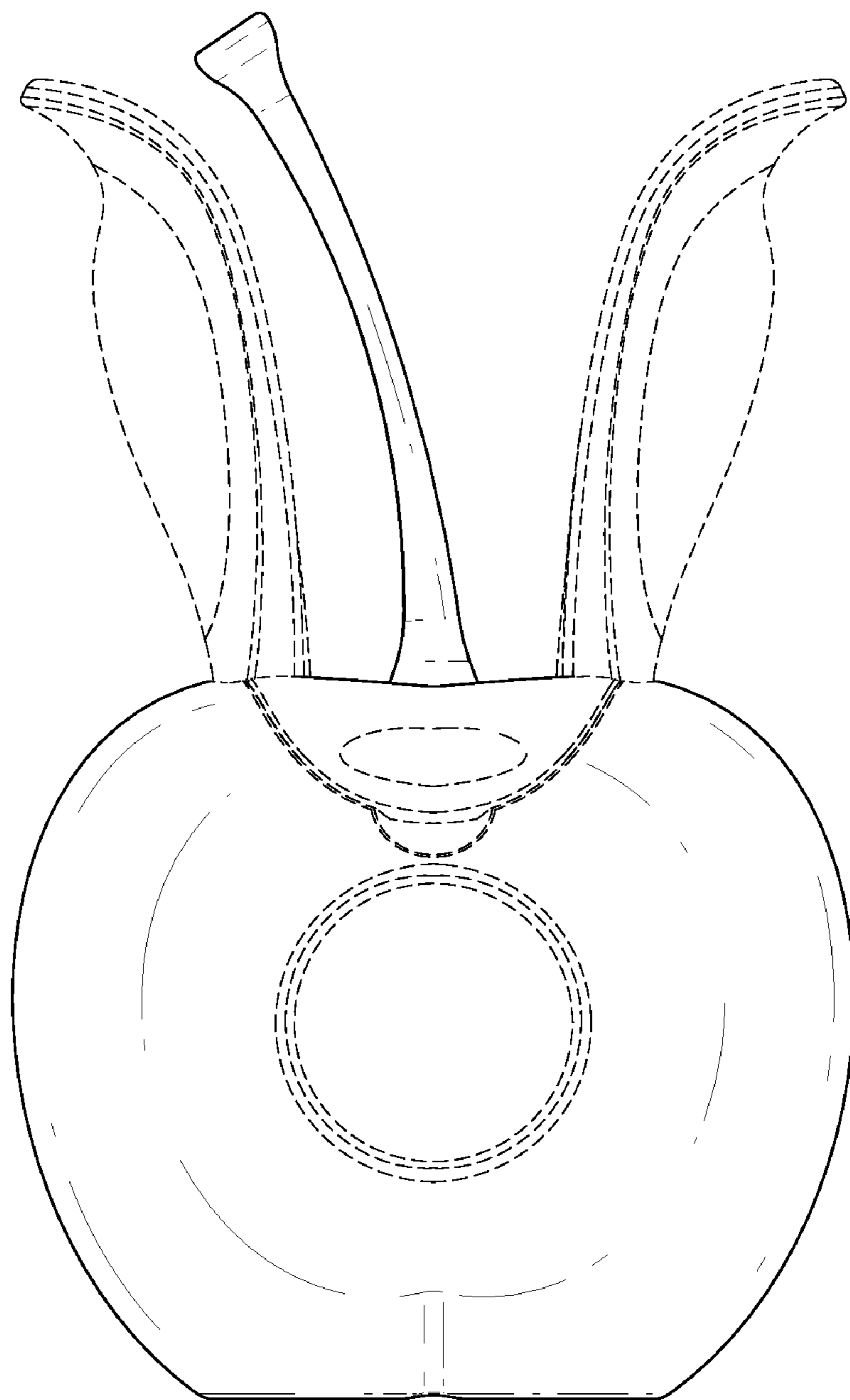

FIG. 2

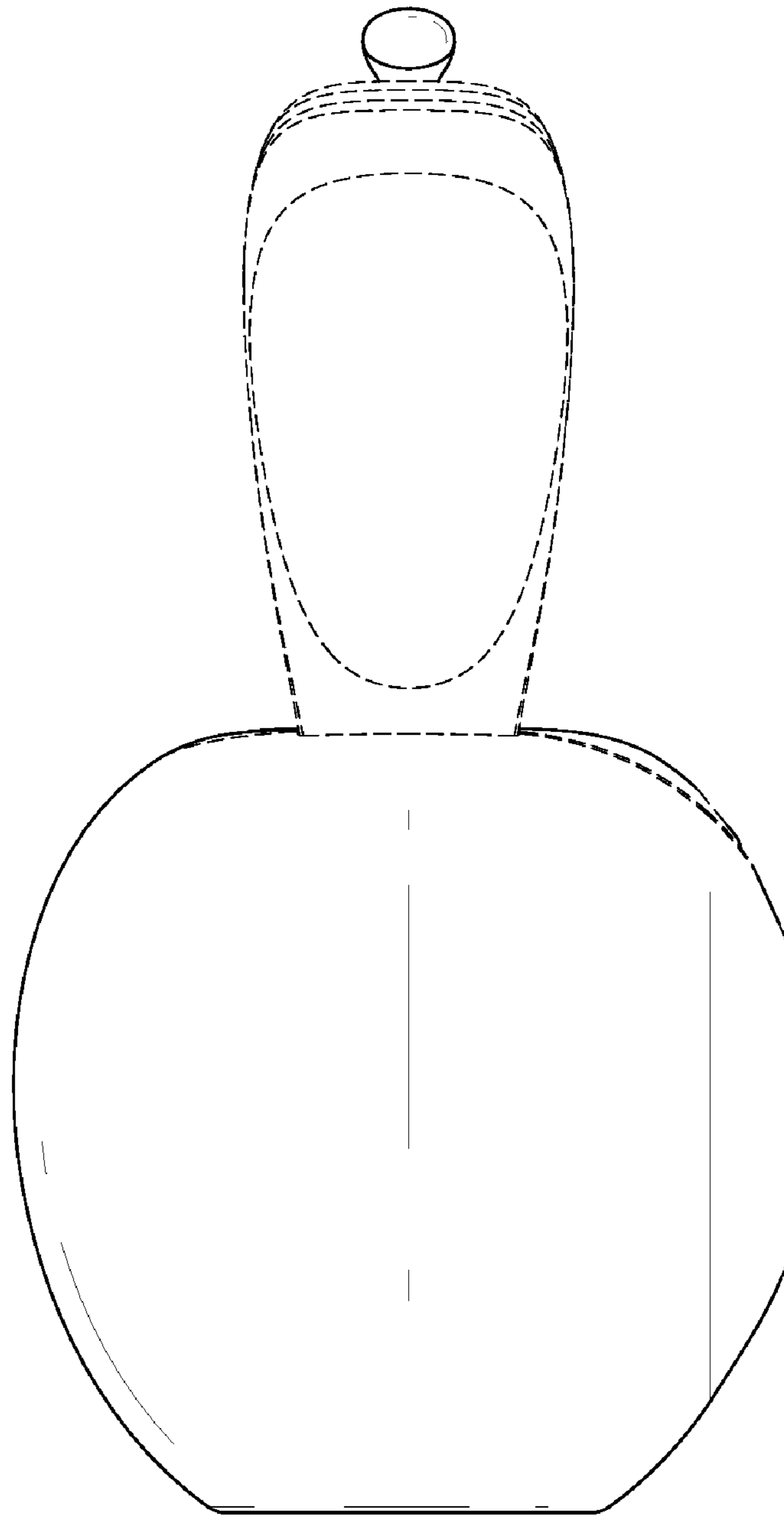

FIG. 3

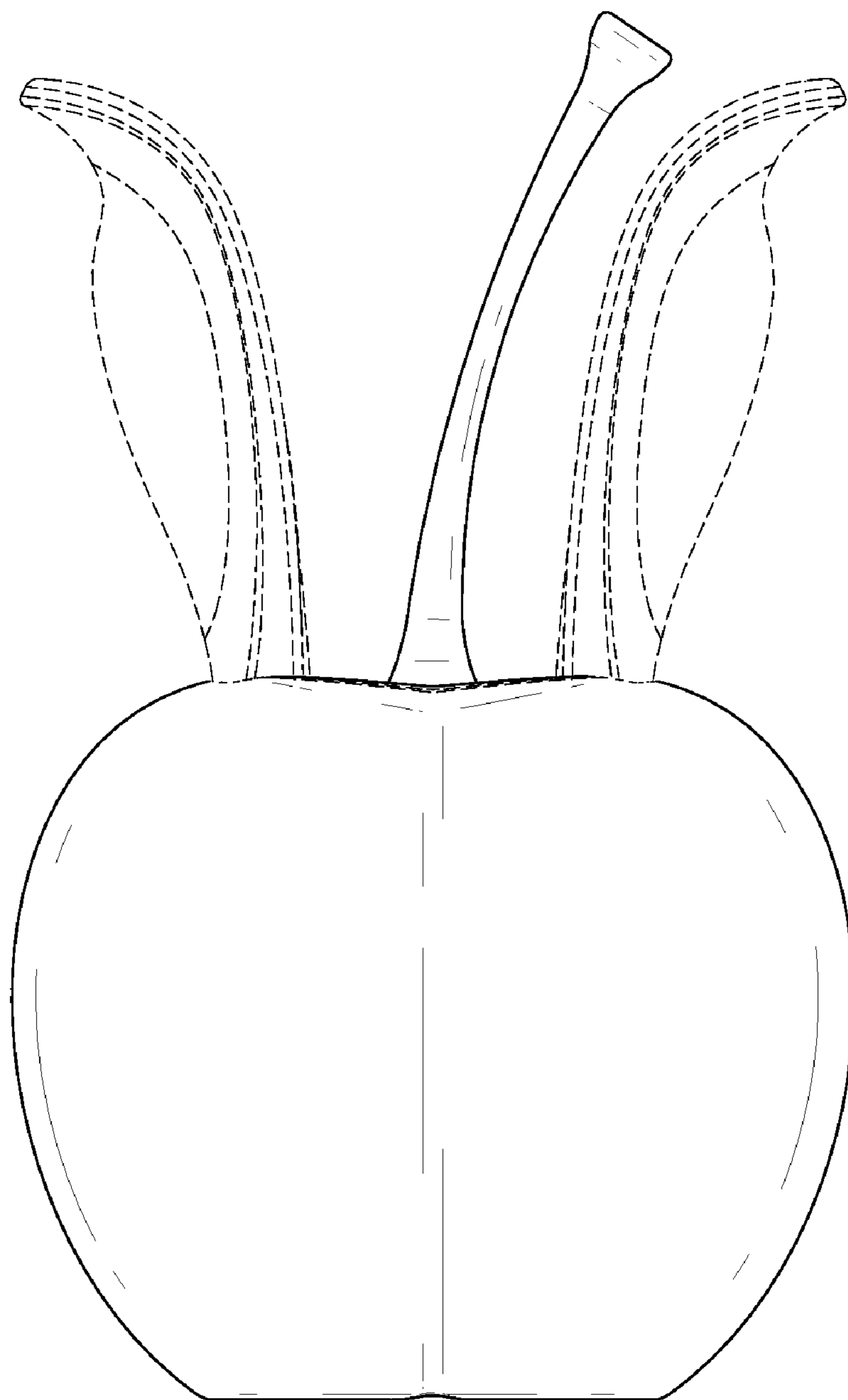

FIG. 4

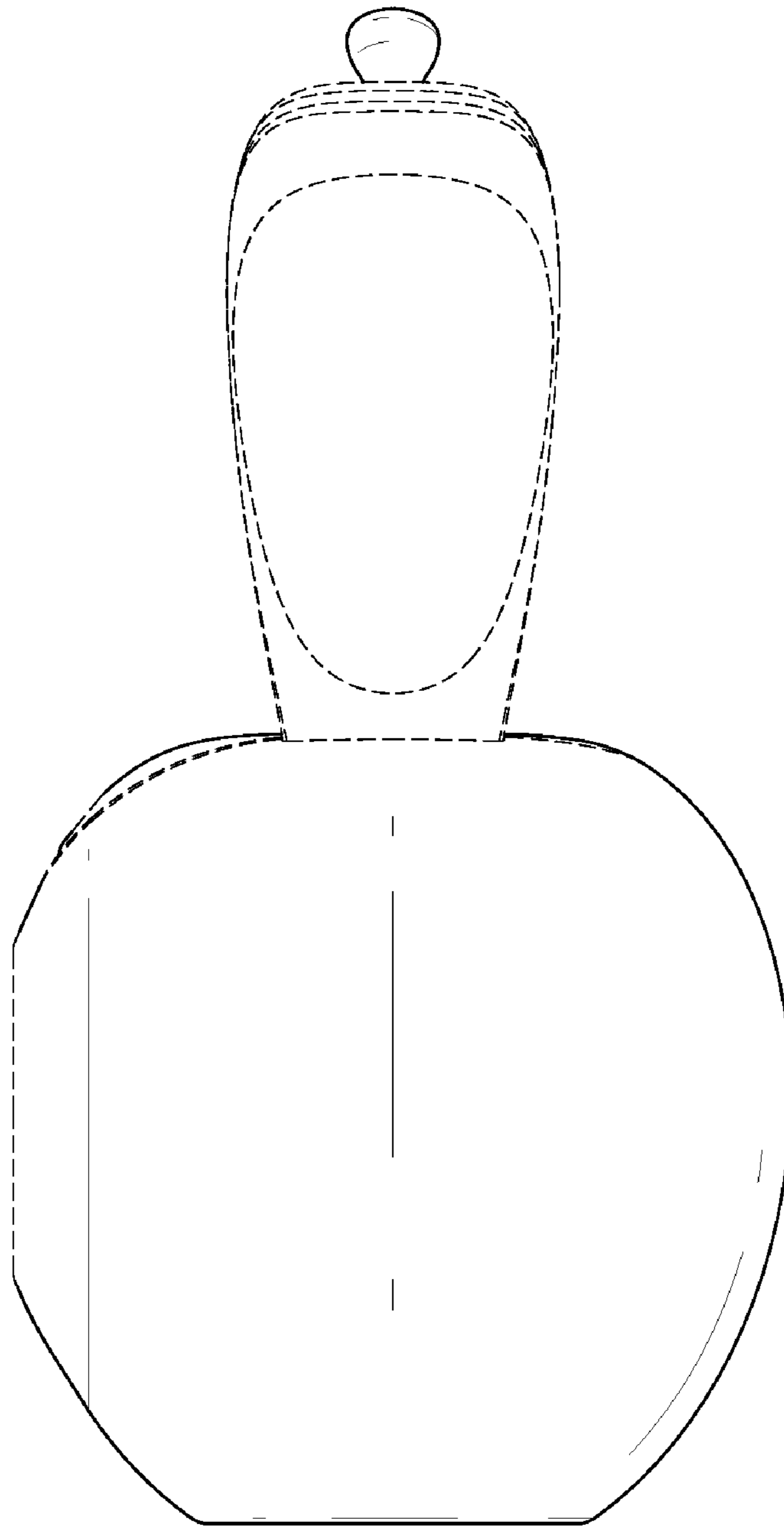

FIG. 5

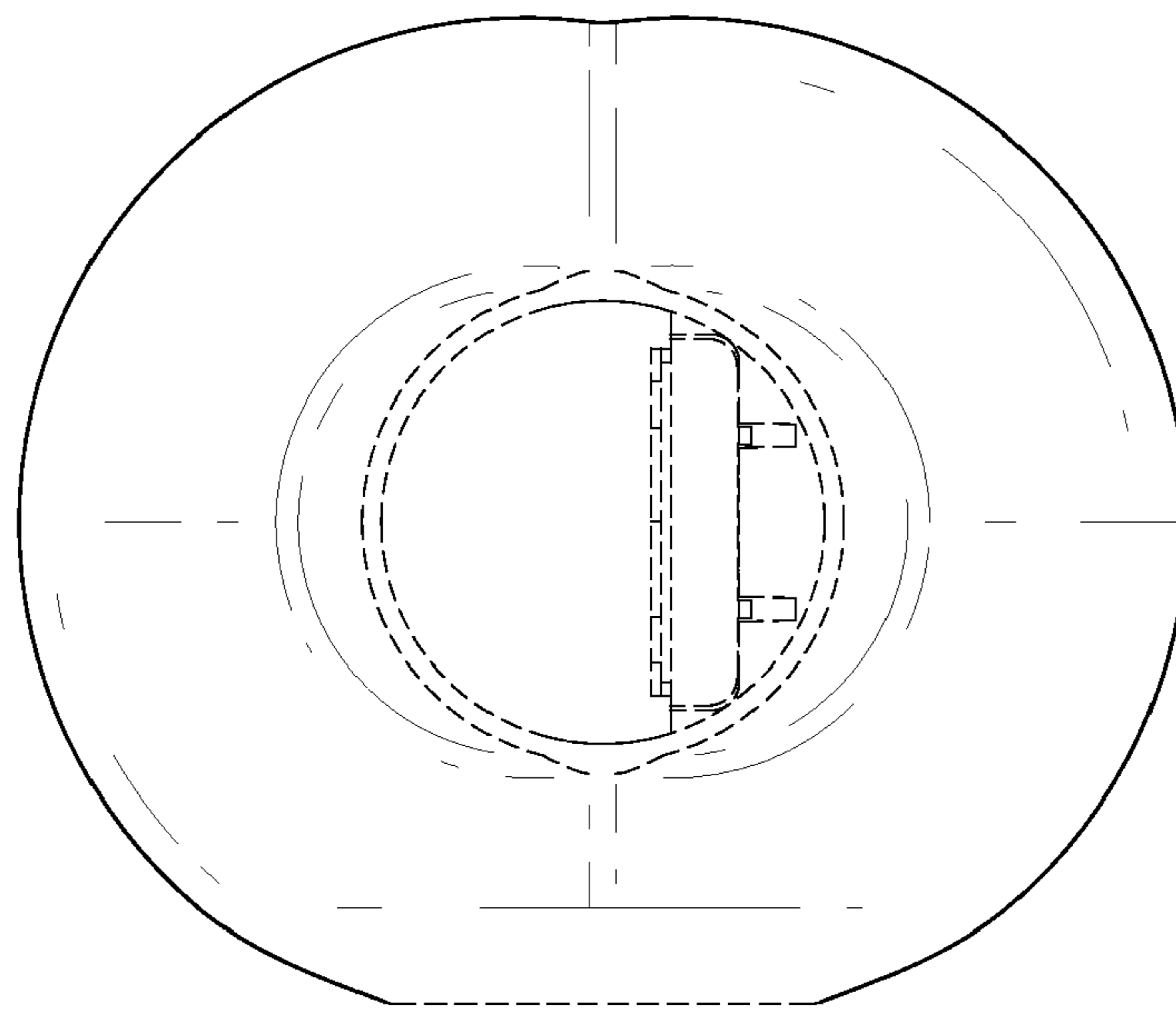

FIG. 6

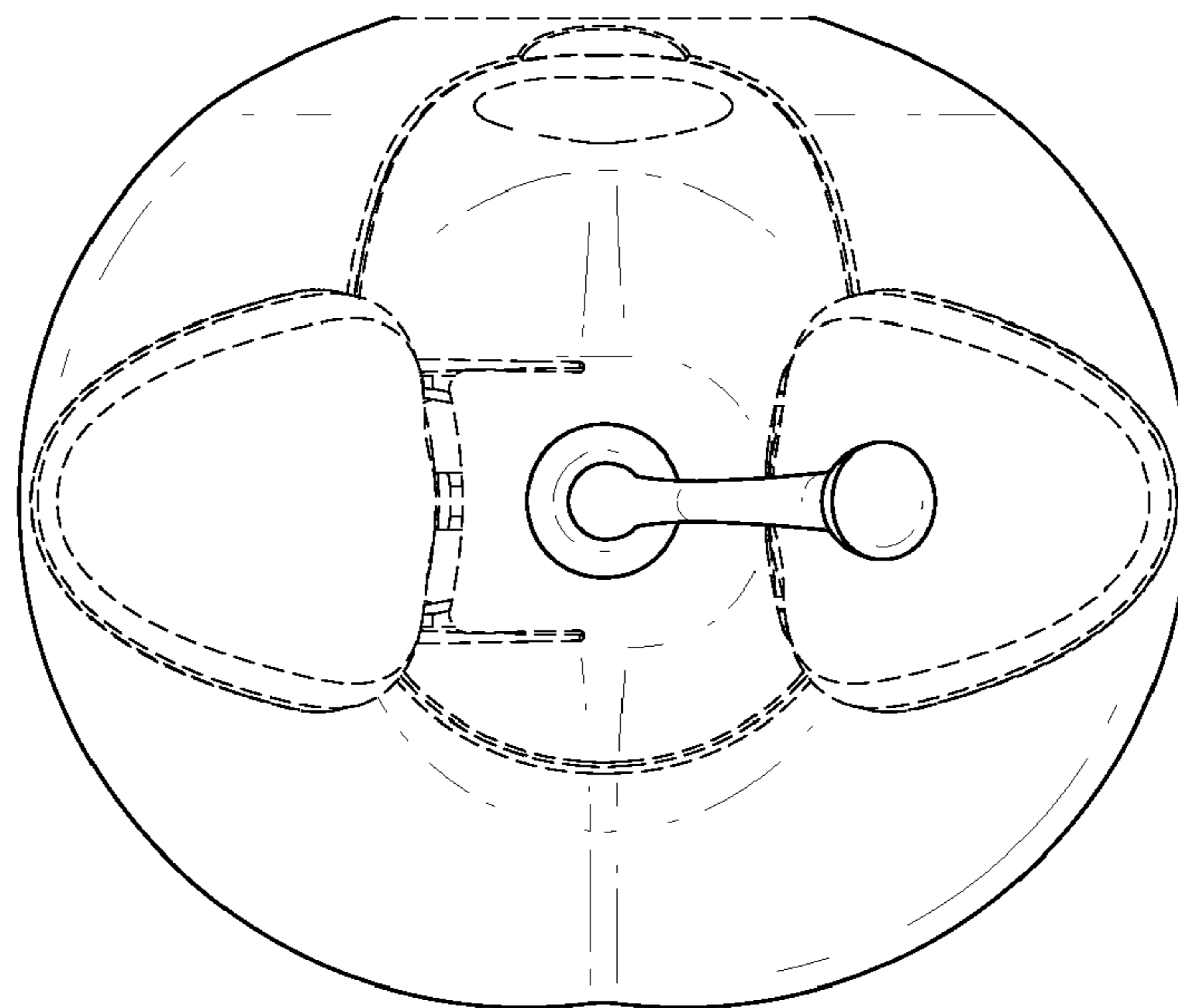

FIG. 7