



US00D615371S

(12) **United States Design Patent**  
**Krus et al.**

(10) **Patent No.:** **US D615,371 S**

(45) **Date of Patent:** **\*\* May 11, 2010**

(54) **GRINDER**

(75) Inventors: **Matthew Krus**, Seattle, WA (US);  
**David A. Holcomb**, Seattle, WA (US)

(73) Assignee: **Chef'n Corporation**, Seattle, WA (US)

(\*\*) Term: **14 Years**

(21) Appl. No.: **29/338,711**

(22) Filed: **Jun. 17, 2009**

(51) **LOC (9) Cl.** ..... **07-06**

(52) **U.S. Cl.** ..... **D7/679; D7/401.1**

(58) **Field of Classification Search** ..... D7/590–597,  
D7/679, 401.1; 222/480, 142.1–142.9; 241/168,  
241/169, 169.1, 273.1–273.4, 286  
See application file for complete search history.

(56) **References Cited**

**U.S. PATENT DOCUMENTS**

D108,364 S *	2/1938	Buma	.....	D7/594
D337,923 S	8/1993	Ancona et al.		
D370,160 S *	5/1996	Holcomb et al.	.....	D7/679
D452,997 S	1/2002	Holcomb et al.		
D453,096 S	1/2002	Stewart et al.		
D464,852 S	10/2002	Tang		

6,672,524 B1 *	1/2004	Holcomb et al.	.....	241/169
D504,278 S	4/2005	Tardif		
D565,909 S	4/2008	Krus		
D565,911 S	4/2008	Jossem et al.		

\* cited by examiner

*Primary Examiner*—Terry A Wallace

(74) *Attorney, Agent, or Firm*—Seed IP Law Group PLLC

(57) **CLAIM**

The ornamental design for a grinder, as shown and described.

**DESCRIPTION**

FIG. 1 is a front isometric view of a grinder showing our new design.

FIG. 2 is a rear elevation view thereof.

FIG. 3 is a right side elevation view thereof.

FIG. 4 is a front elevation view thereof.

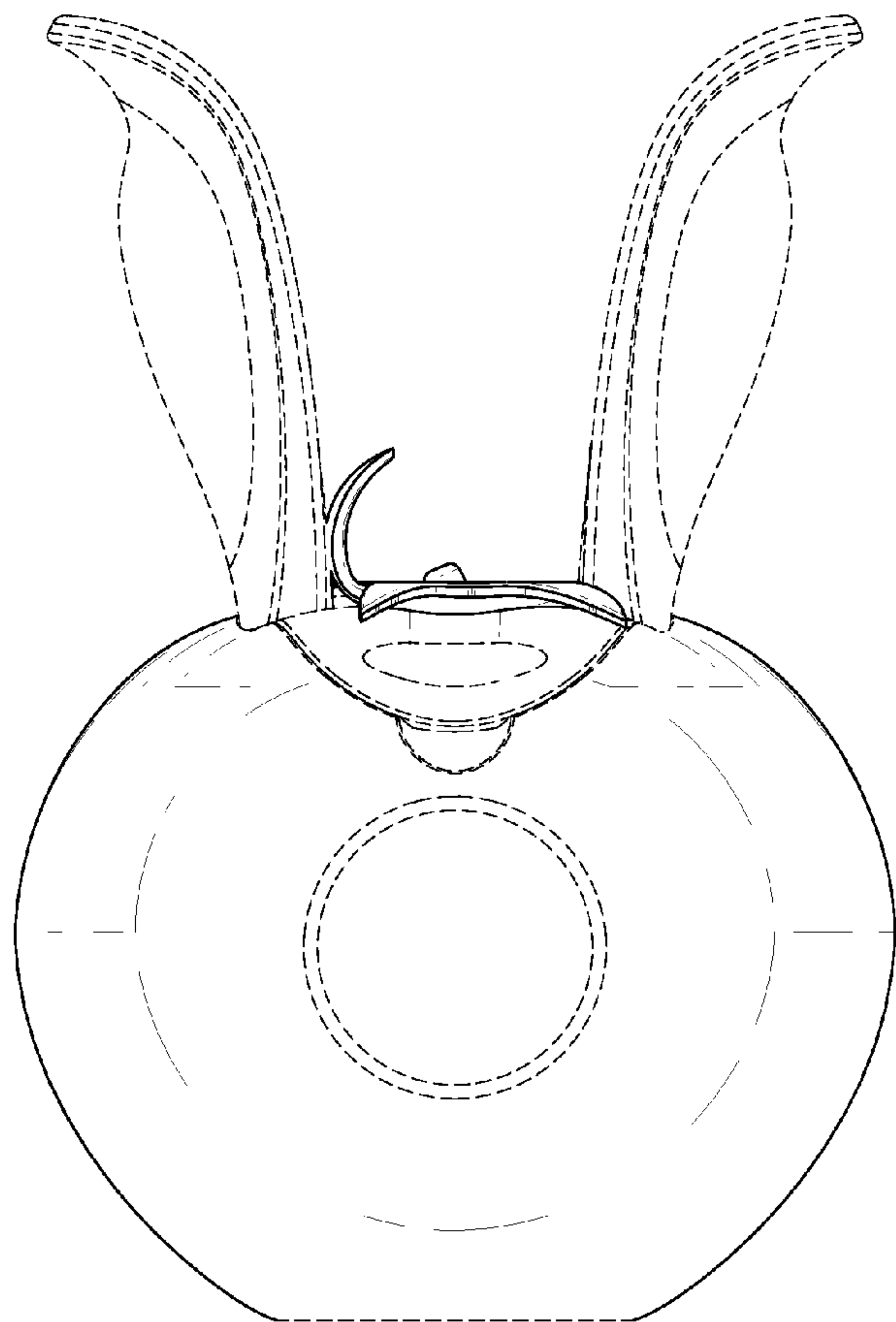
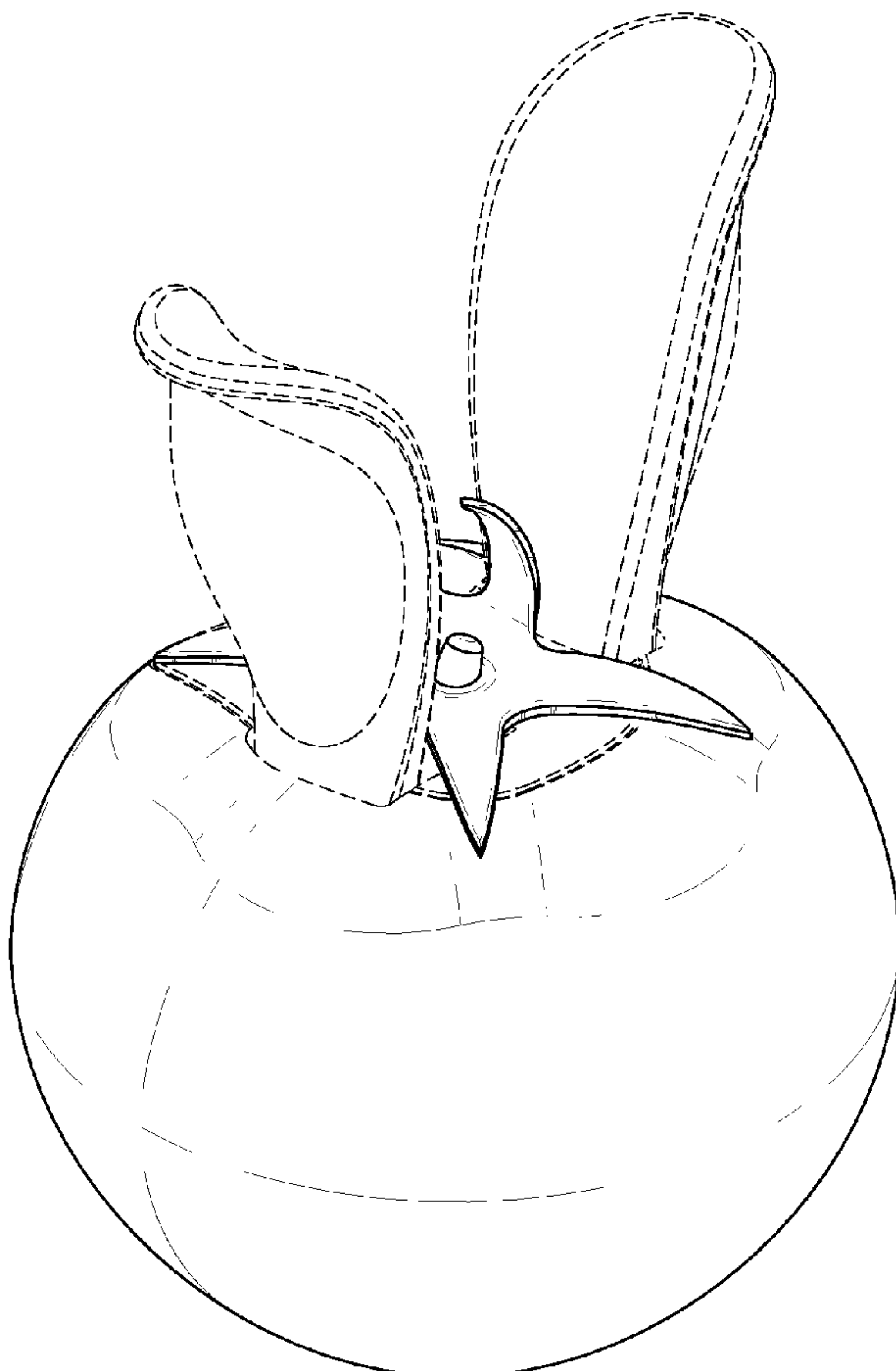
FIG. 5 is a left side elevation view thereof.

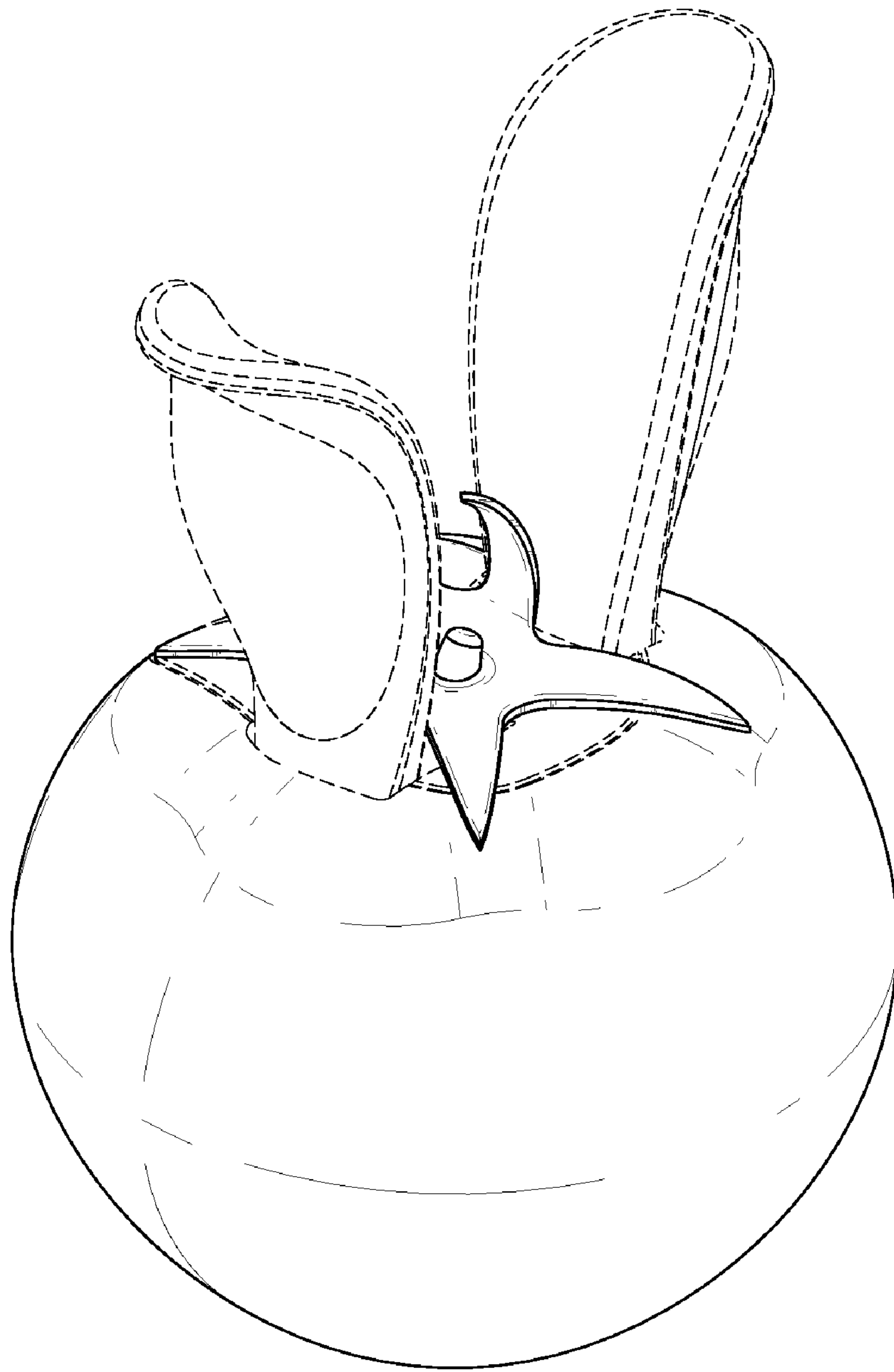
FIG. 6 is a bottom plan view thereof; and,

FIG. 7 is a top plan view thereof.

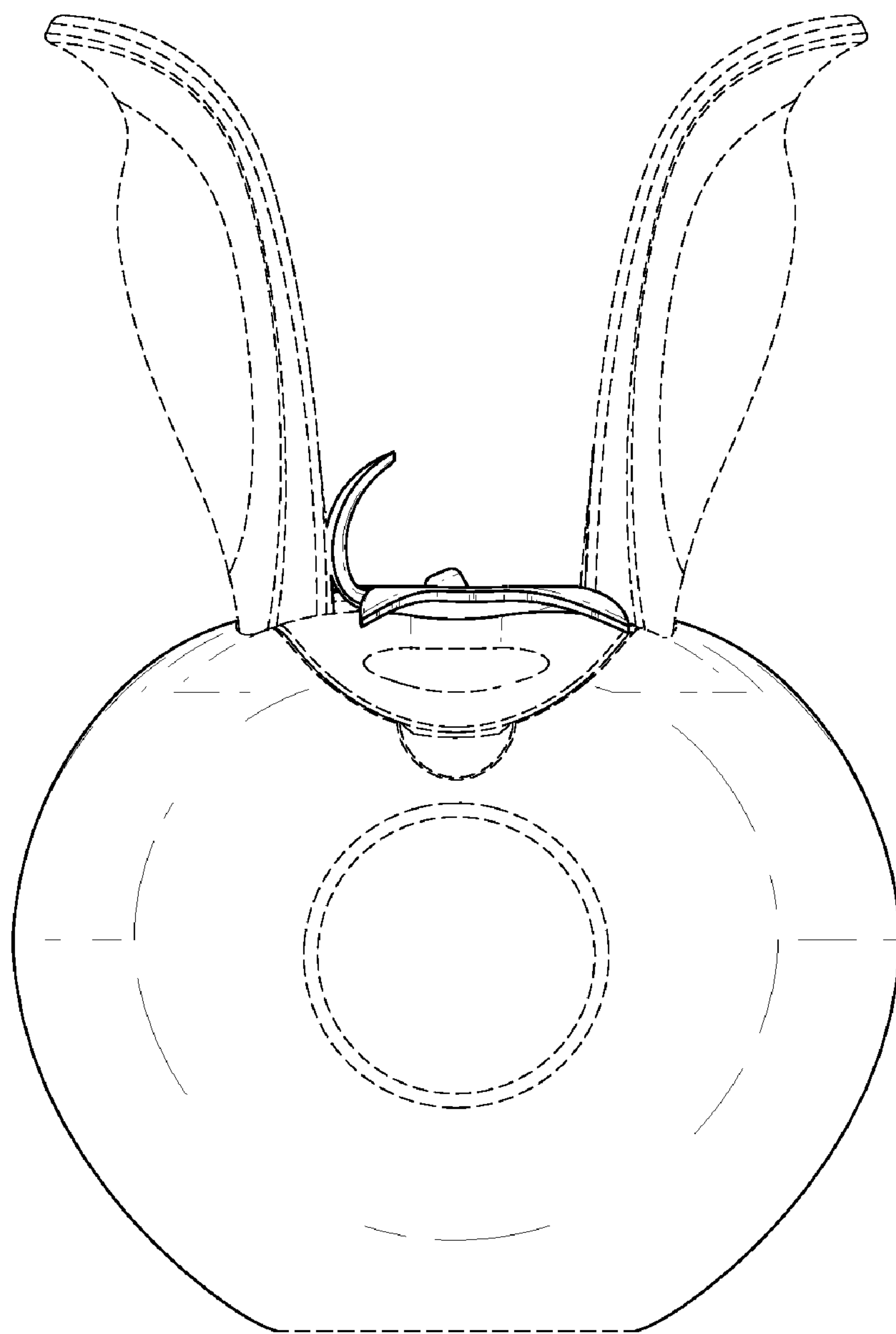
The broken lines in the figures are for illustrative purposes only and form no part of the claimed design.

**1 Claim, 6 Drawing Sheets**

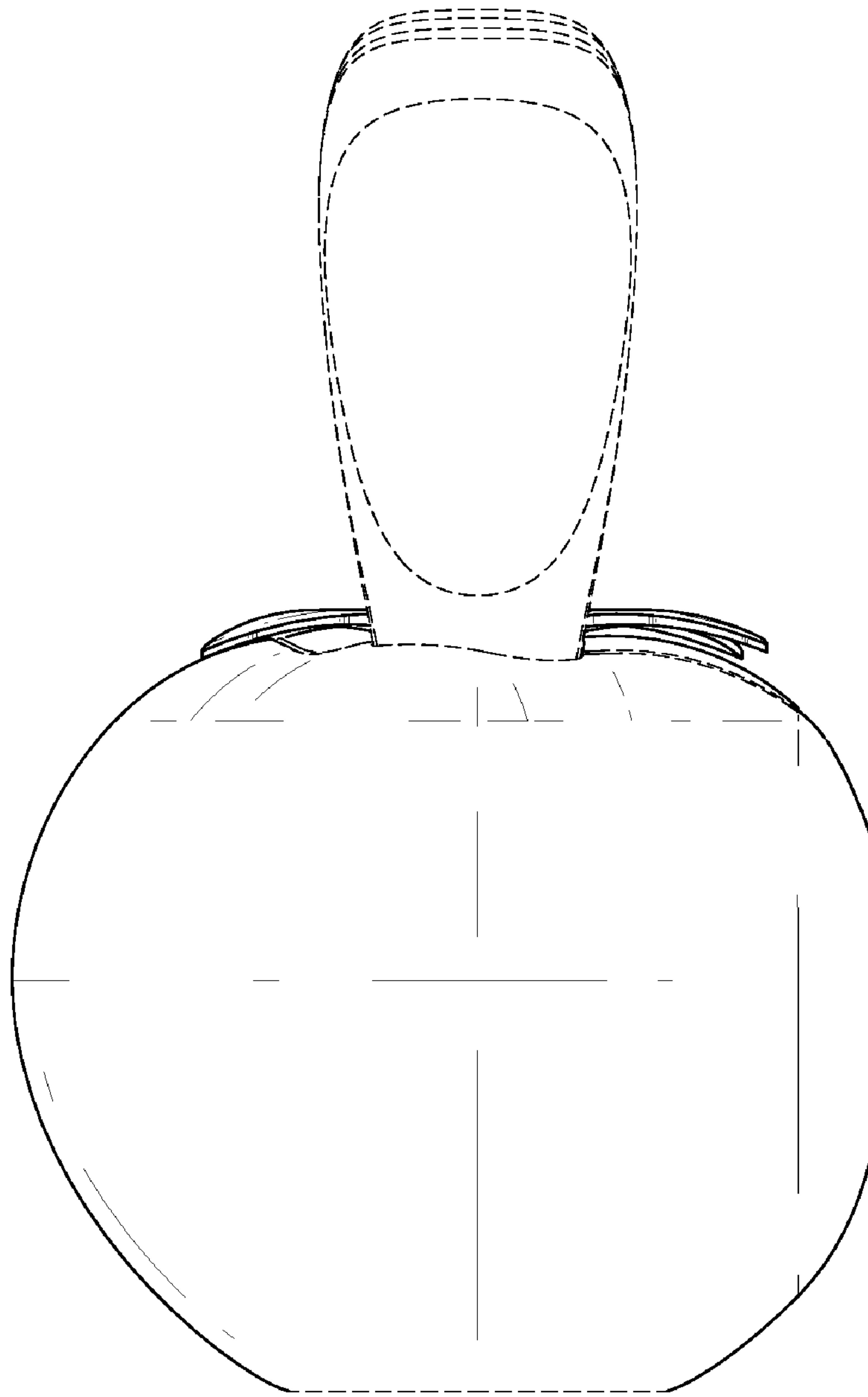




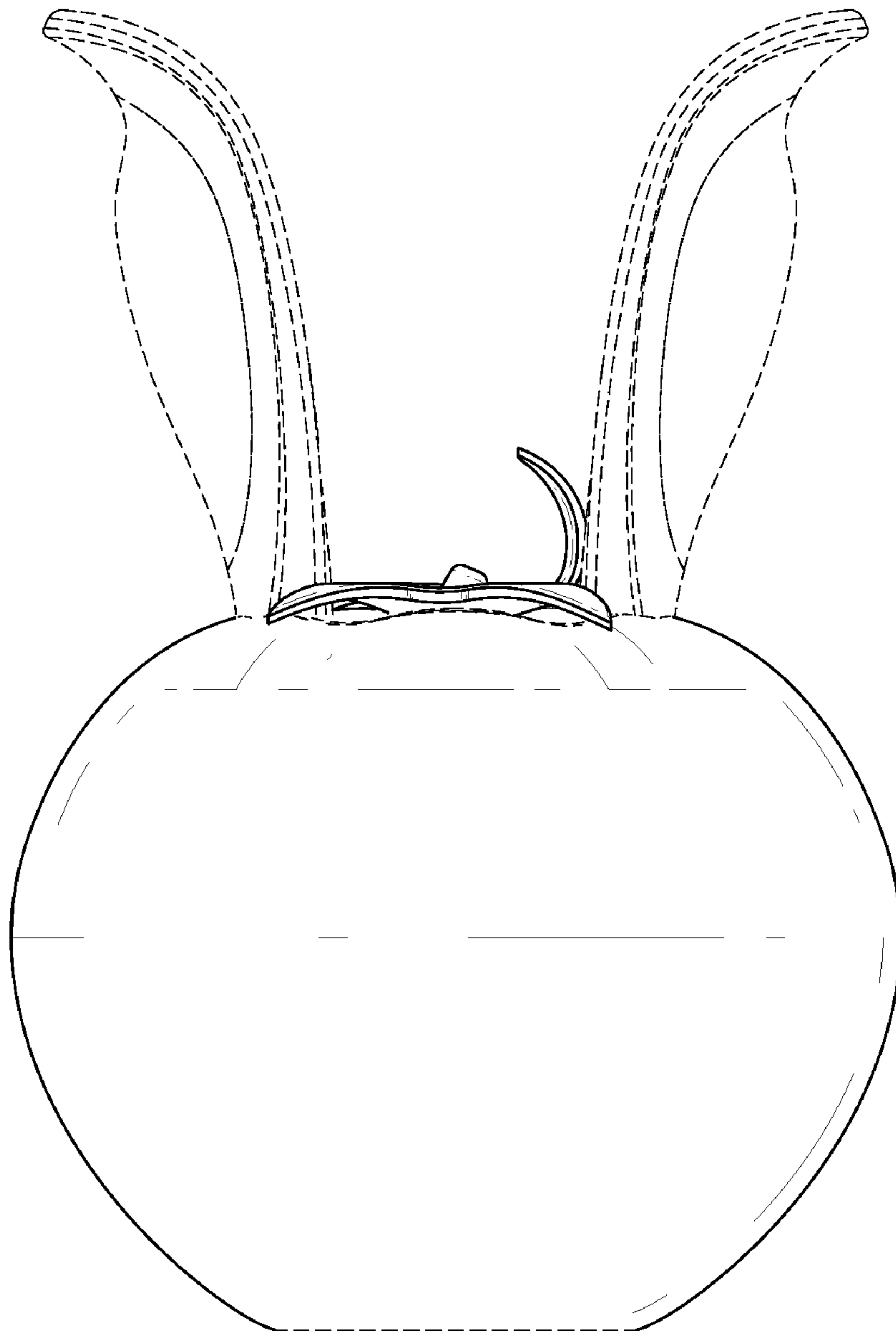
*FIG. 1*



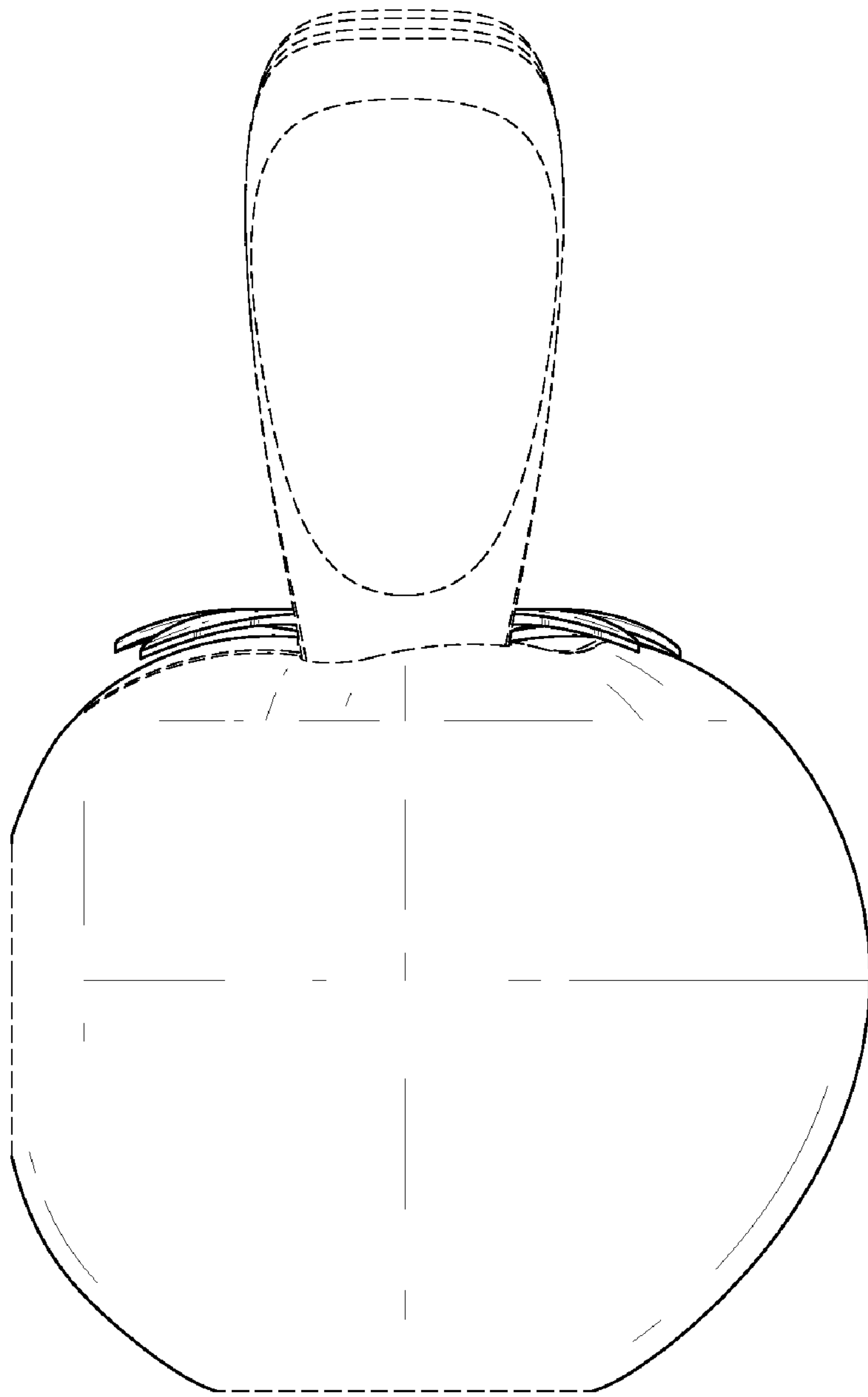
*FIG. 2*



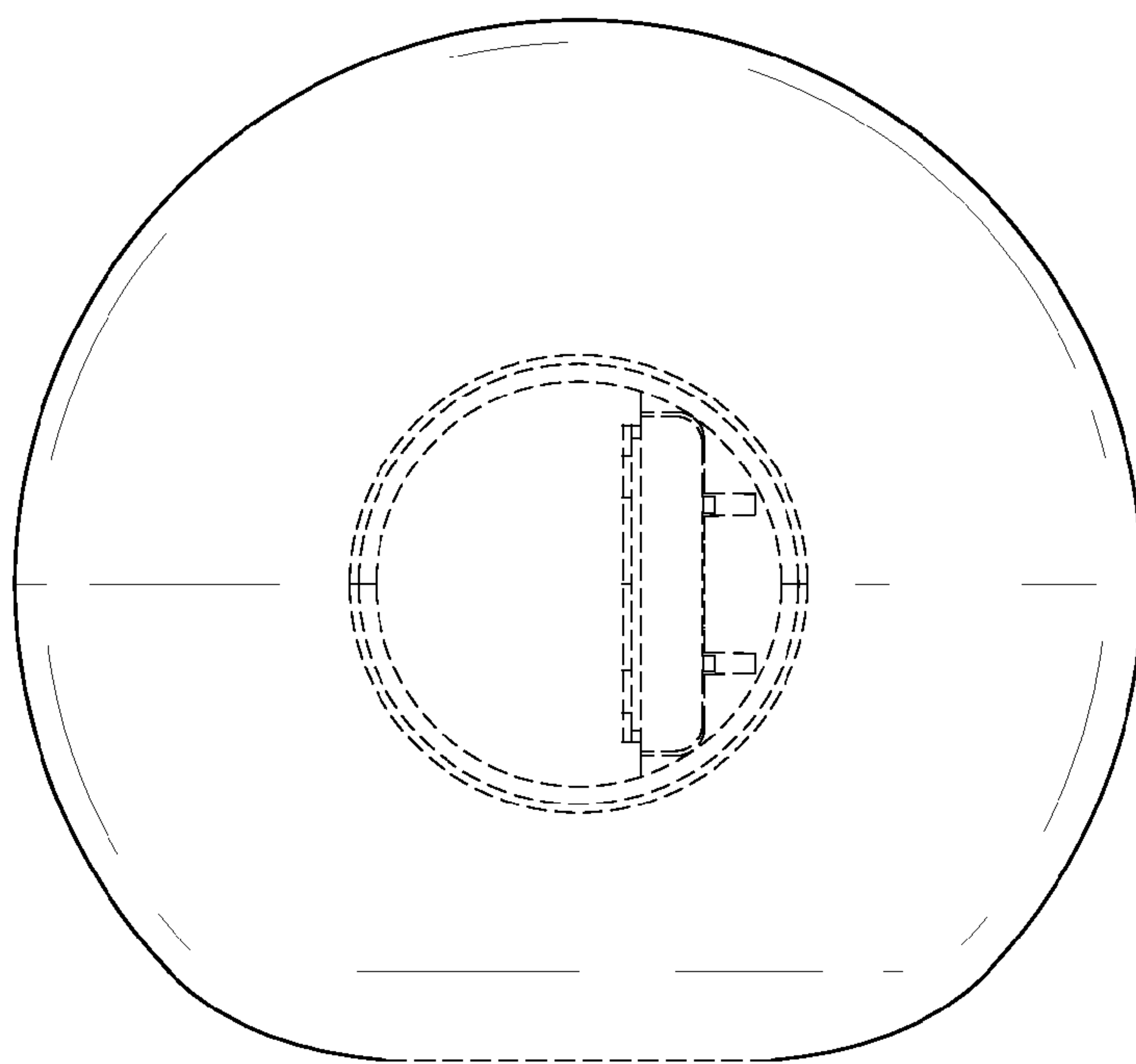
*FIG. 3*



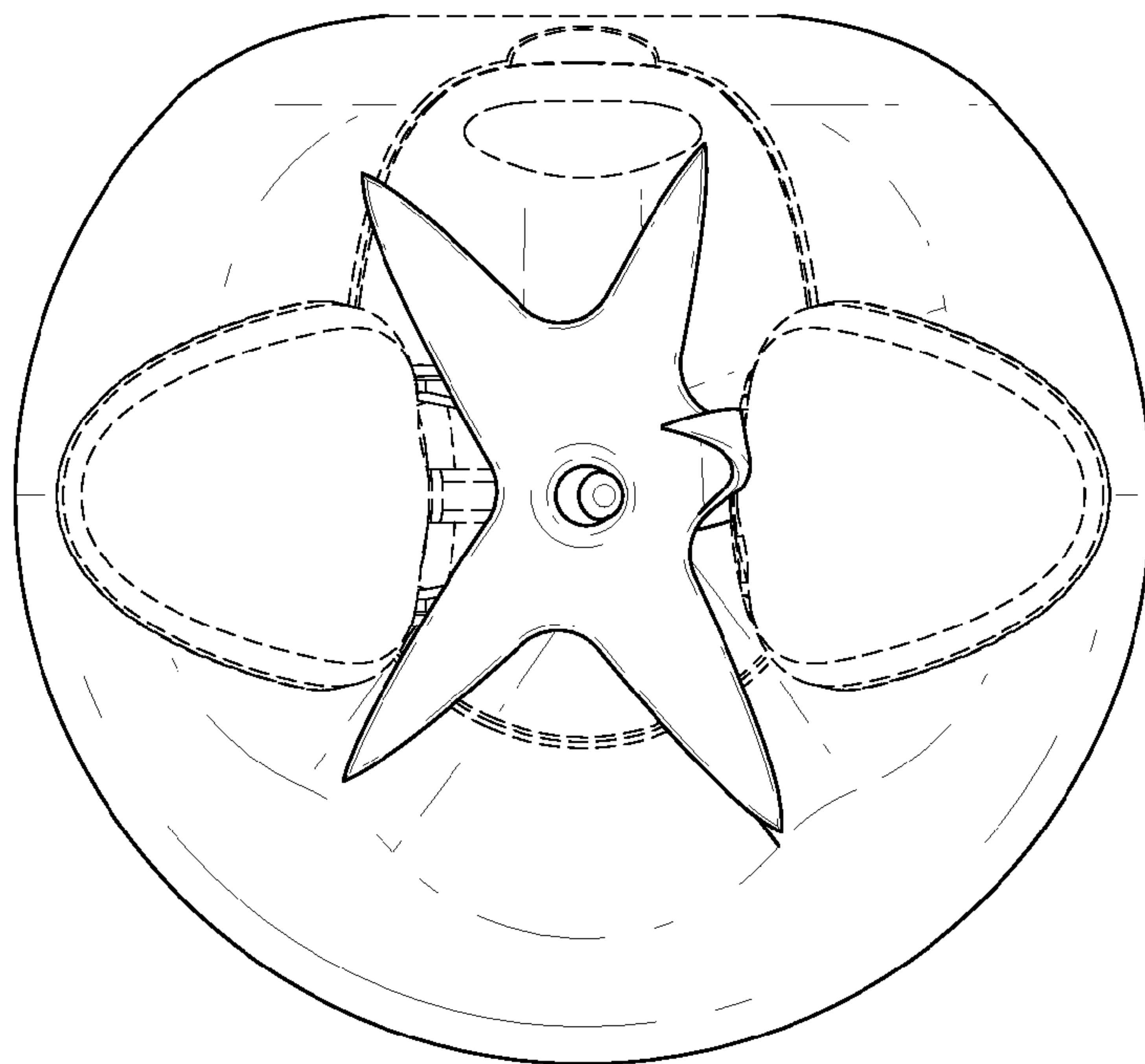
*FIG. 4*



*FIG. 5*



*FIG. 6*



*FIG. 7*