



US00D615364S

(12) **United States Design Patent**
Fryman

(10) **Patent No.:** **US D615,364 S**
(45) **Date of Patent:** **** May 11, 2010**

(54) **INSULATED CONTAINER HOLDER**

(76) Inventor: **Monte Fryman**, 931 Robinson Berry Rd., Berry, KY (US) 41003

(**) Term: **14 Years**

(21) Appl. No.: **29/315,402**

(22) Filed: **Jun. 23, 2009**

(51) **LOC (9) Cl.** **07-01**

(52) **U.S. Cl.** **D7/607; D3/229**

(58) **Field of Classification Search** D7/605,
D7/607, 619.1; D3/229; 62/457.1-457.9;
224/148.1-148.6

See application file for complete search history.

(56) **References Cited**

U.S. PATENT DOCUMENTS

4,197,890	A *	4/1980	Simko	383/97
5,048,734	A	9/1991	Long		
D353,520	S *	12/1994	Schwartz	D7/607
D373,678	S *	9/1996	Haigis	D3/229
D379,119	S *	5/1997	Wolfe et al.	D3/229
D379,711	S *	6/1997	Fitzgerald	D3/202
D414,930	S *	10/1999	Rausch	D3/229
6,550,271	B2 *	4/2003	Silbert	62/457.4
D549,444	S	8/2007	Schneckenberg		

* cited by examiner

Primary Examiner—Terry A Wallace
(74) *Attorney, Agent, or Firm*—Paul R. Martin

(57) **CLAIM**

The ornamental design for a insulated container holder, as shown and described.

DESCRIPTION

FIG. 1 is a perspective view of the insulated container holder of this invention.

FIG. 2 is an elevational front view of the insulated container holder shown in FIG. 1.

FIG. 3 is a top plan view of the insulated container holder shown in FIG. 1.

FIG. 4 is an elevational rear view of the insulated container holder shown in FIG. 1.

FIG. 5 is a bottom plan view of the insulated container holder shown in FIG. 1.

FIG. 6 is a elevational view of one side of the the insulated container holder shown in FIG. 1; and,

FIG. 7 is a elevational view of the opposite side to that shown in FIG. 6, of the insulated container holder shown in FIG. 1.

The dotted line depicting a cap or closure in FIG. 1, forms no part of the invention.

1 Claim, 4 Drawing Sheets

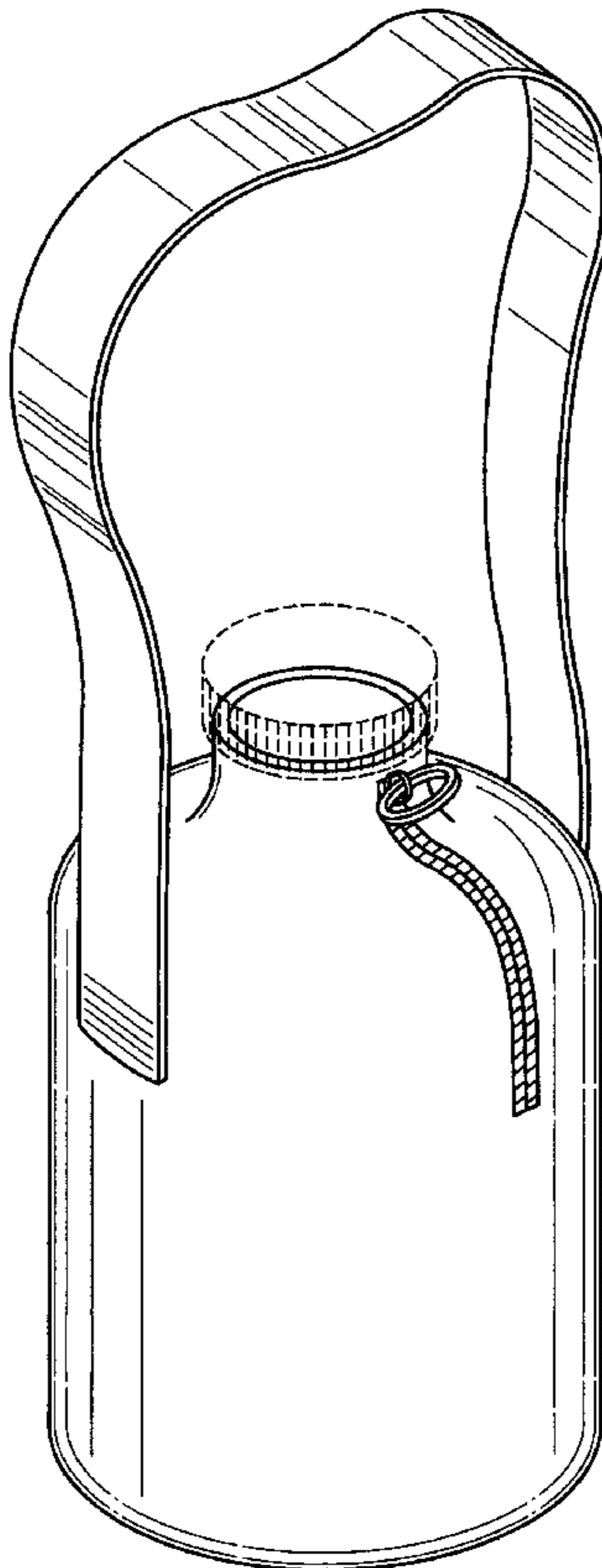

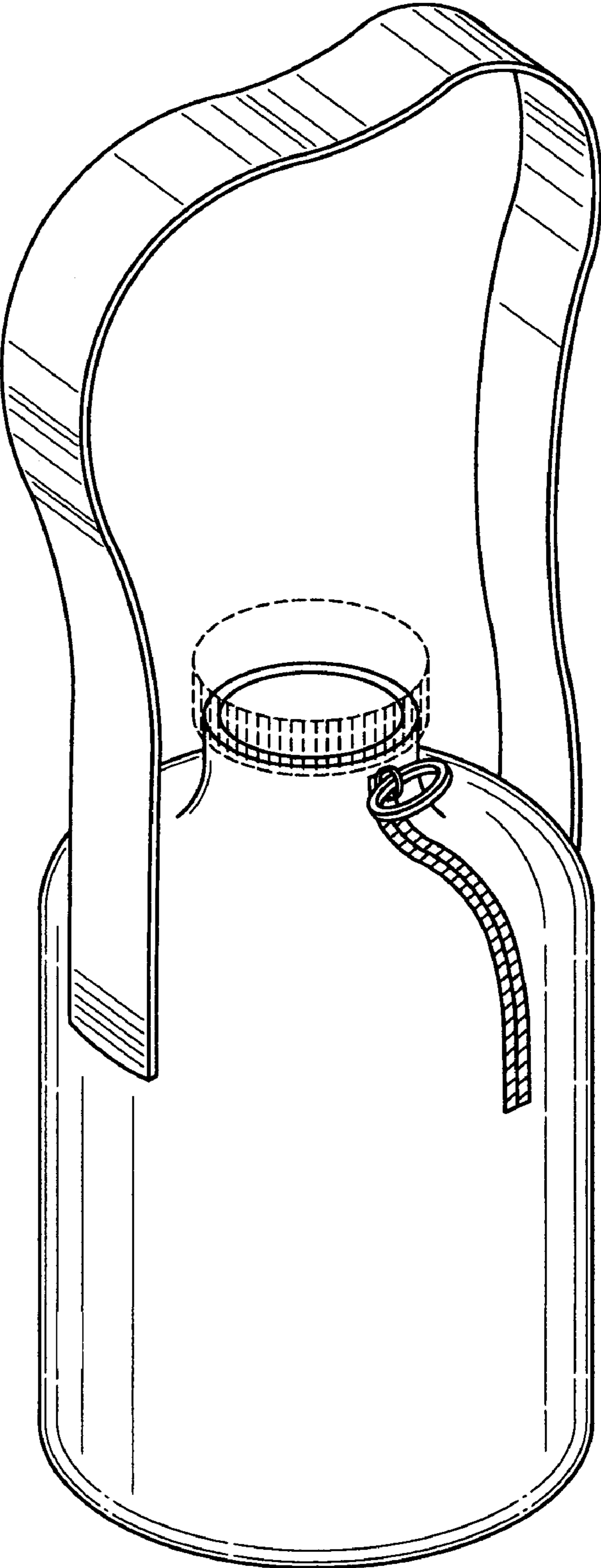

FIG. 1

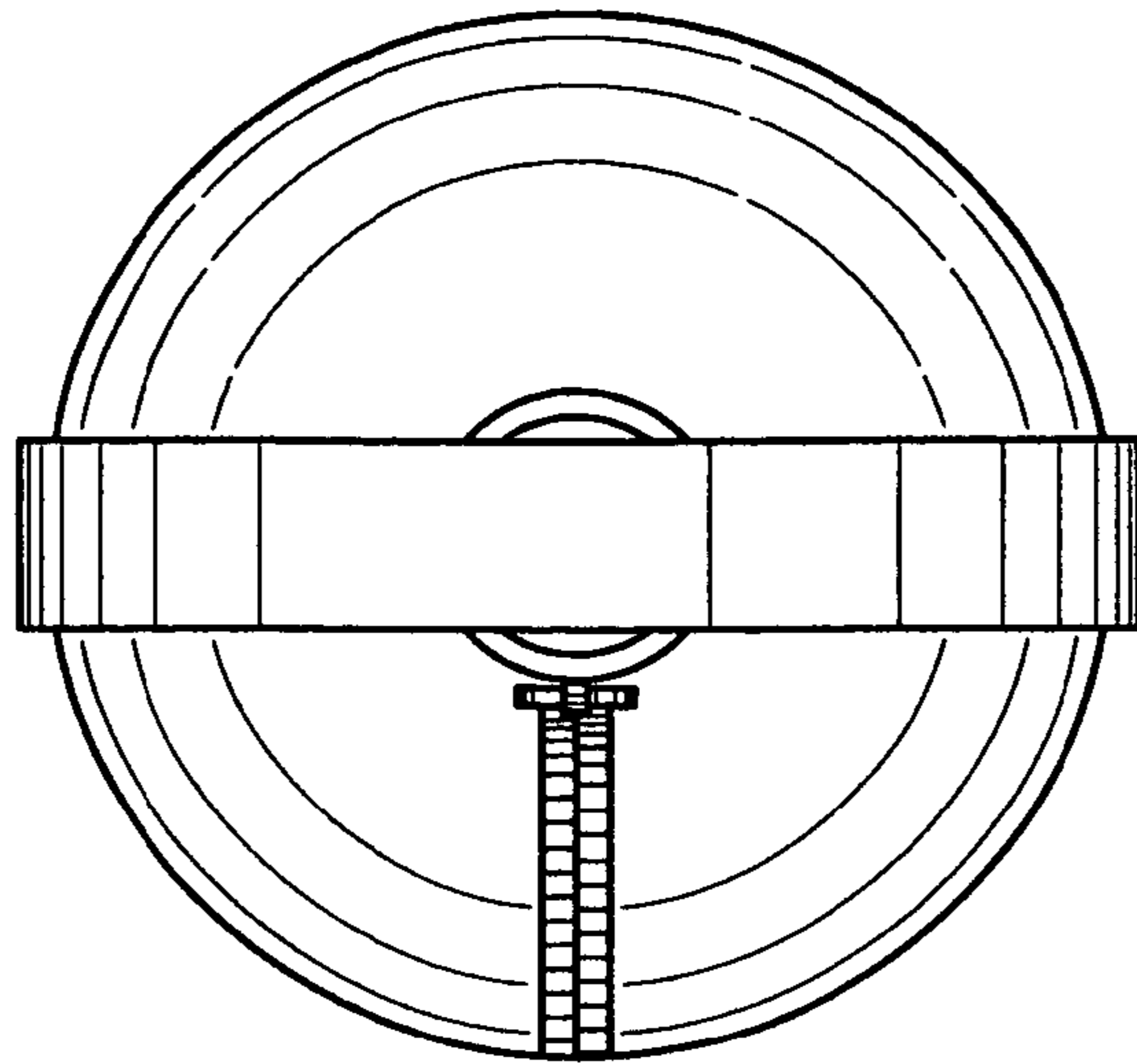

FIG. 3

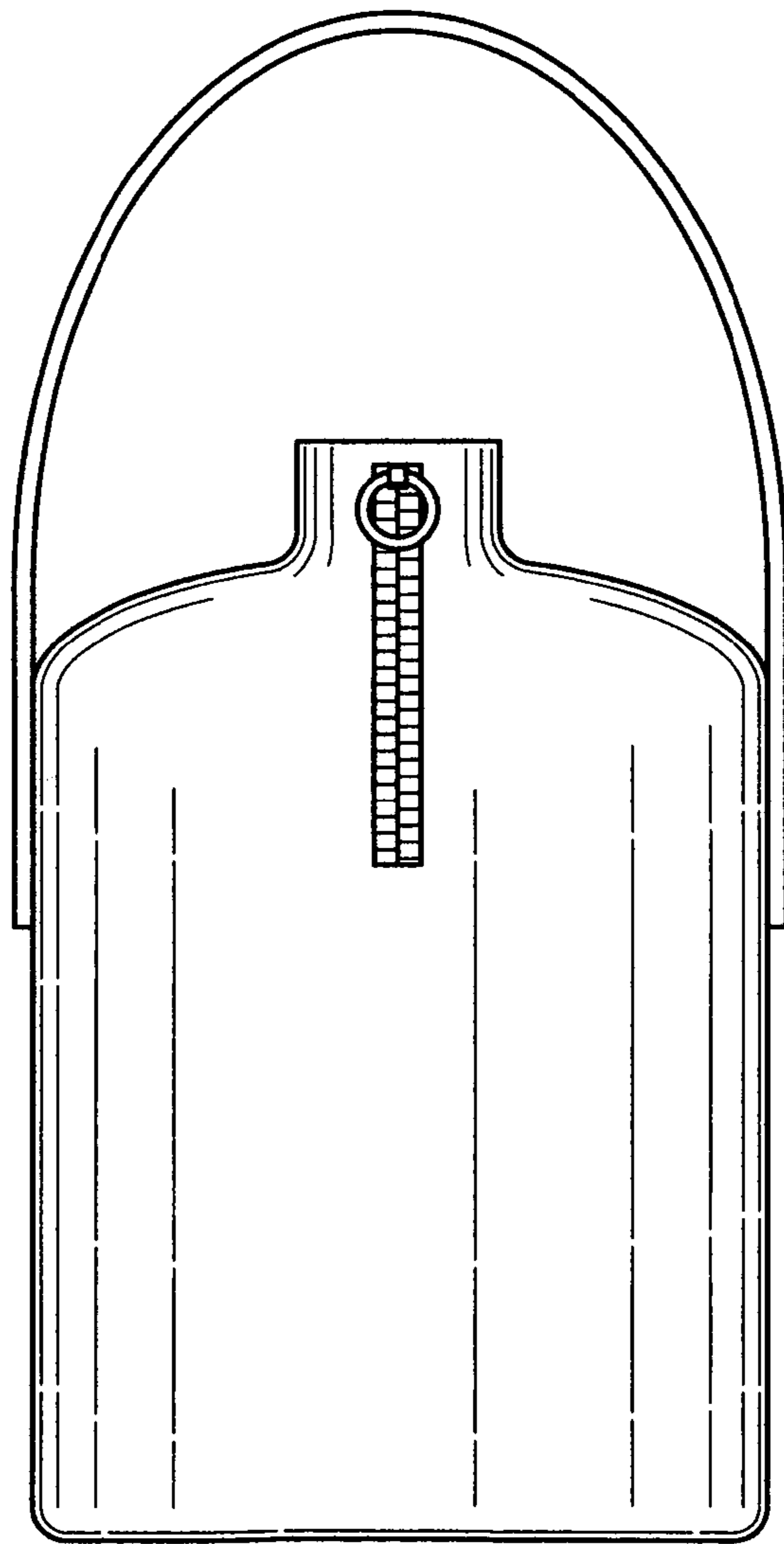

FIG. 2

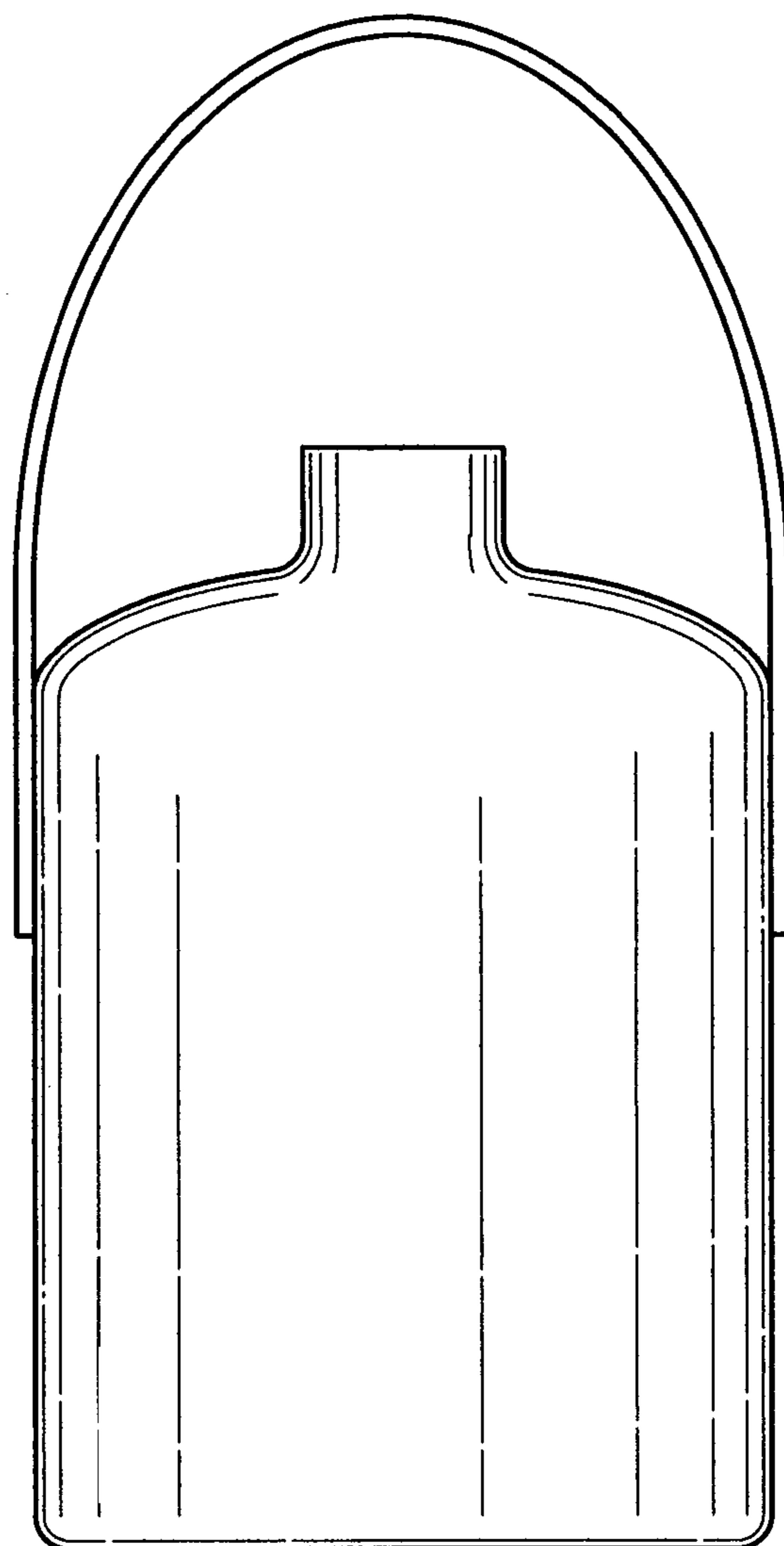

FIG. 4

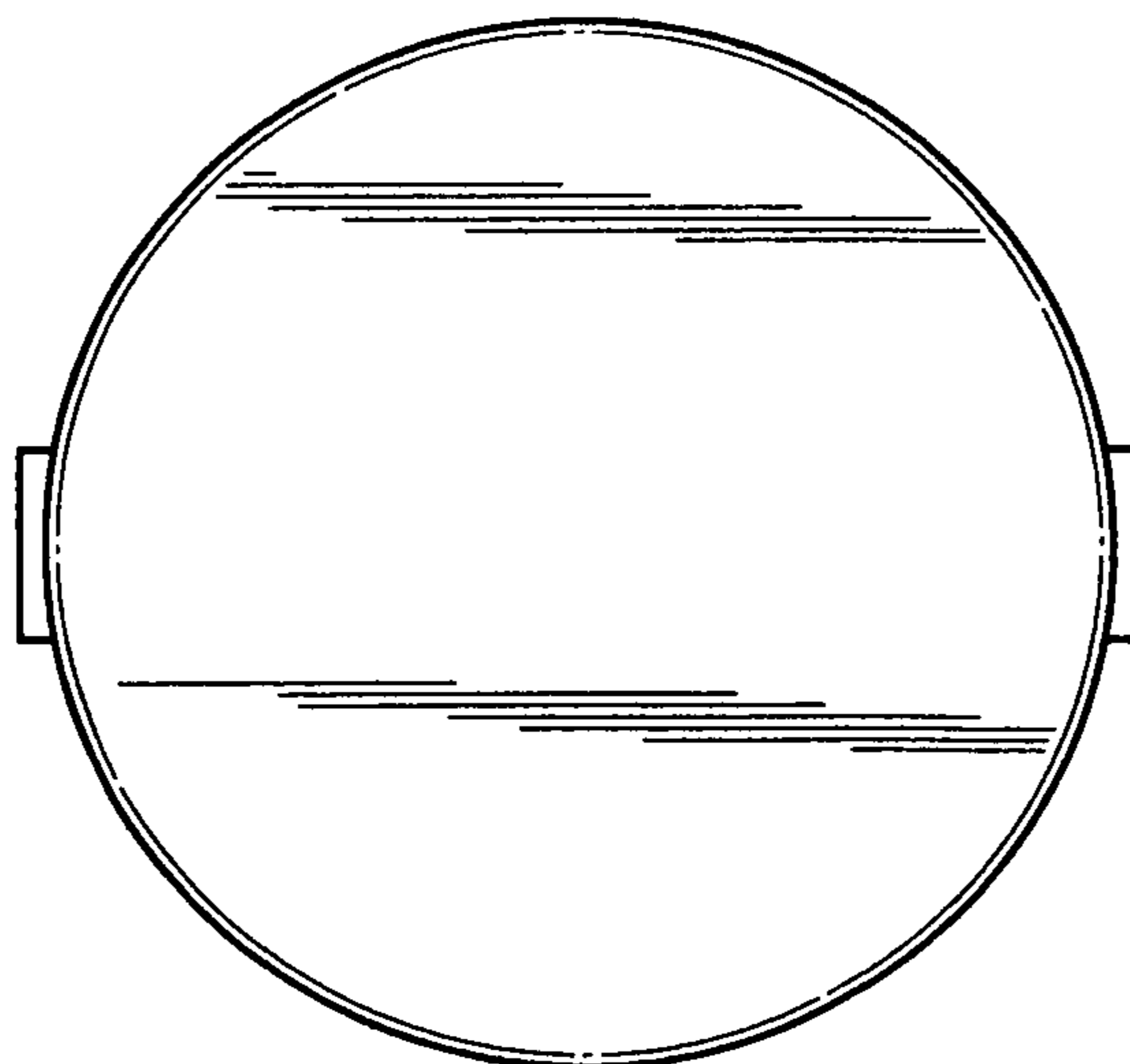

FIG. 5

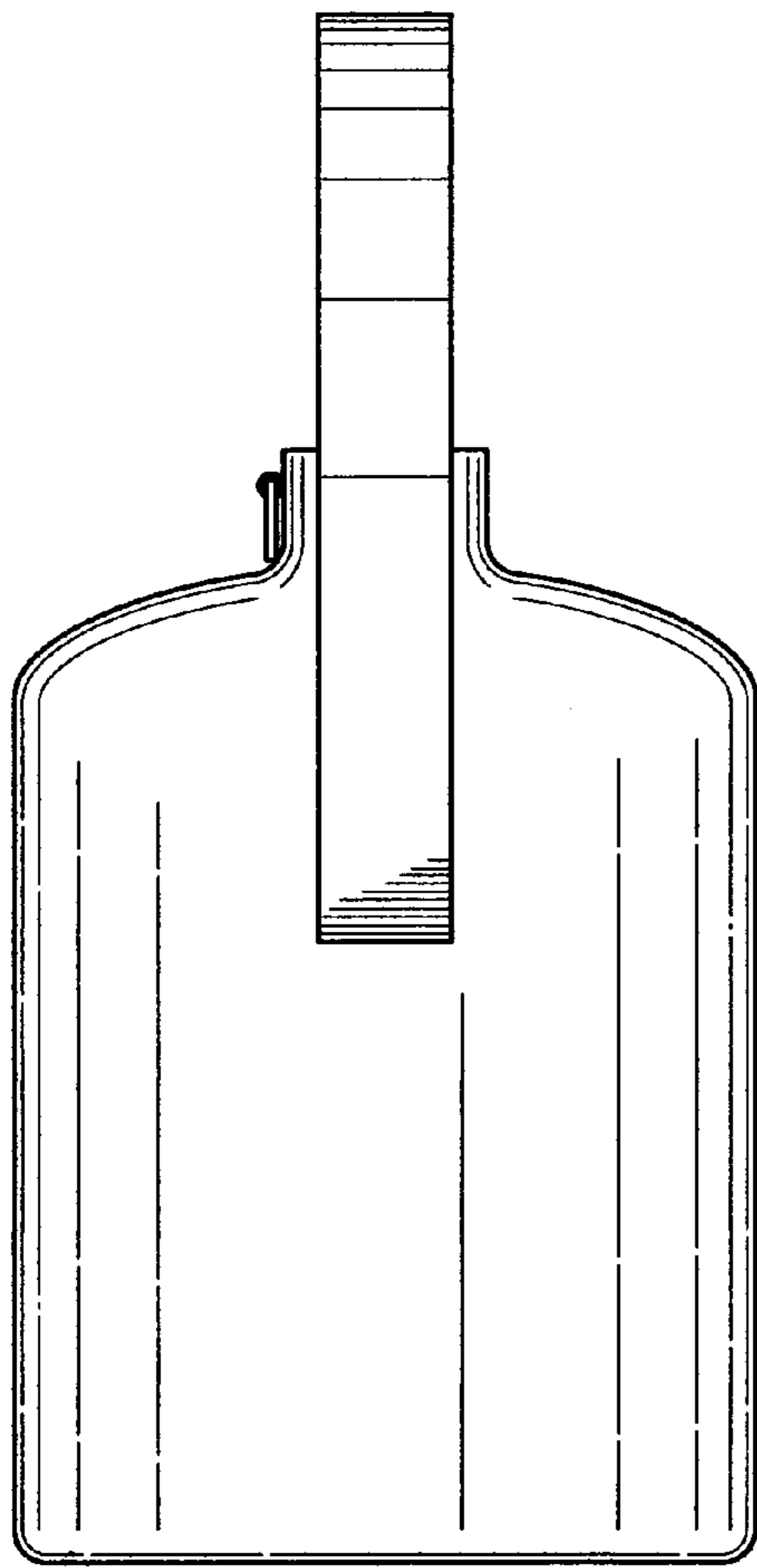

FIG. 6

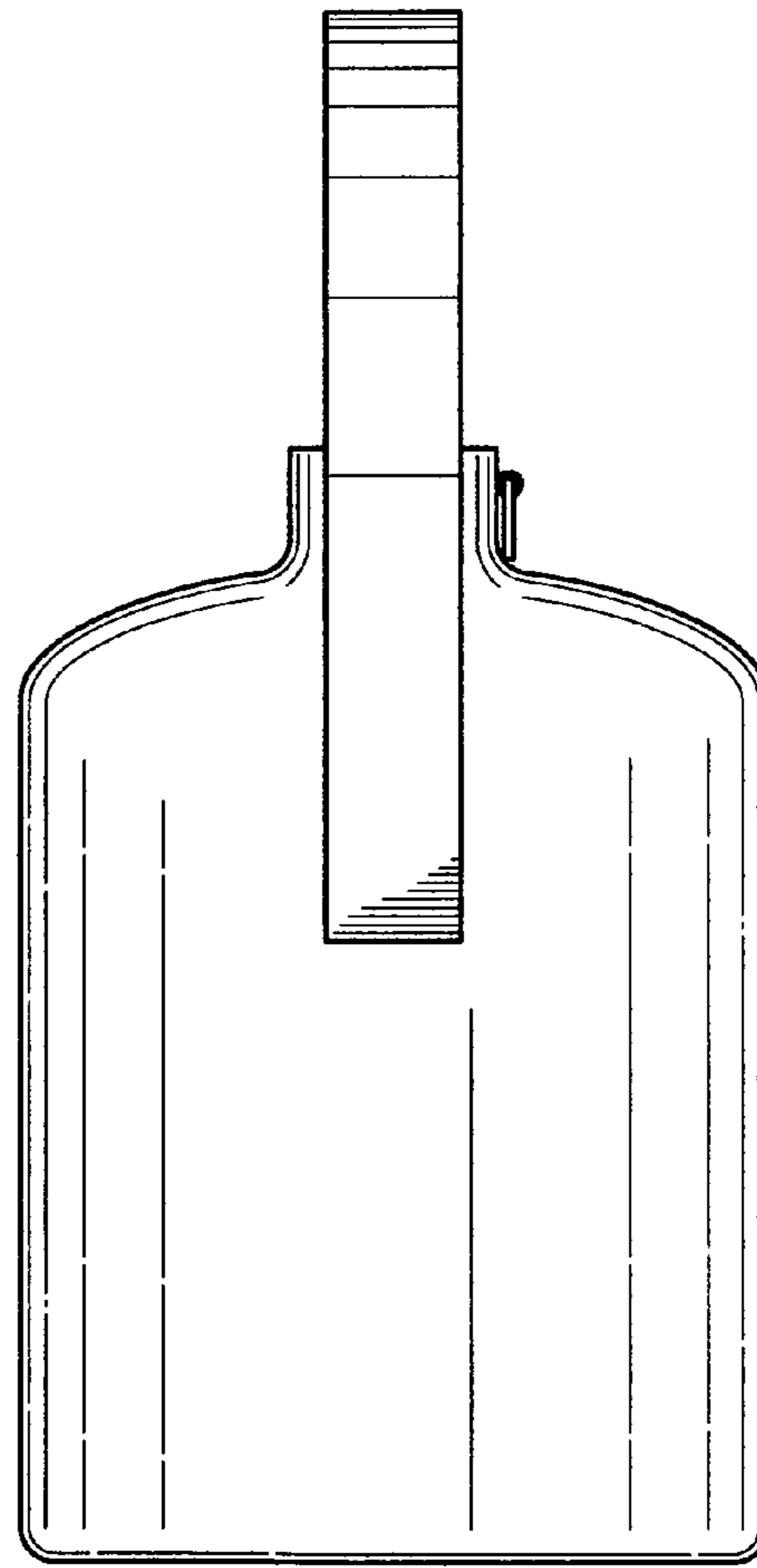

FIG. 7