



US00D615313S

(12) **United States Design Patent**  
**Rooth**

(10) **Patent No.:** **US D615,313 S**

(45) **Date of Patent:** **\*\* May 11, 2010**

(54) **LOUNGE CHAIR MADE FROM RECLAIMED WINE BARREL STAVES**

D341,265 S 11/1993 Gehry  
D345,656 S 4/1994 Theobald  
D350,860 S 9/1994 Greeson  
D420,824 S 2/2000 Lin  
D566,411 S 4/2008 Lee  
D570,127 S 6/2008 Spink

(76) Inventor: **Gustaf Anders Rooth**, 3811 Ray St.,  
San Diego, CA (US) 92104

(\*\*) Term: **14 Years**

\* cited by examiner

(21) Appl. No.: **29/351,869**

*Primary Examiner*—Mimosa De

(22) Filed: **Dec. 11, 2009**

(74) *Attorney, Agent, or Firm*—Quick Patents, Inc.; Kevin Prince

(51) **LOC (9) Cl.** ..... **06-01**

(57) **CLAIM**

(52) **U.S. Cl.** ..... **D6/370; D6/379**

(58) **Field of Classification Search** ..... D6/334–336,  
D6/367, 368, 370, 372, 373, 374, 375, 376,  
D6/379, 500–502; 297/31, 40, 46, 411.42,  
297/411.43, 445.1, 446.1, 447.1, 452.63  
See application file for complete search history.

What is claimed is the ornamental design for a lounge chair made from reclaimed wine barrel staves, as shown and described.

**DESCRIPTION**

(56) **References Cited**

FIG. 1 is a perspective view of a lounge chair made from reclaimed wine barrel staves, showing the new design;

**U.S. PATENT DOCUMENTS**

FIG. 2 is a right-side elevational view thereof;

- D114,478 S 4/1939 Terker
- D114,693 S 5/1939 Wood
- D155,880 S 11/1949 Erwin
- 3,061,373 A 10/1962 Sarchia
- D197,512 S \* 2/1964 Poisson ..... D6/375
- D240,873 S \* 8/1976 Lewis ..... D6/368
- D249,307 S 9/1978 Hall
- D269,653 S \* 7/1983 Deconinck ..... D6/368
- D276,106 S 10/1984 Grosfillex
- D295,927 S 5/1988 Hickey
- 5,040,847 A \* 8/1991 Nguyen ..... 297/447.1
- 5,120,071 A 6/1992 Thibault
- D330,463 S 10/1992 Tonon

FIG. 3 is a left-side elevational view thereof;

FIG. 4 is a front elevational view thereof;

FIG. 5 is a rear elevational view thereof;

FIG. 6 is a top plan view thereof; and,

FIG. 7 is a bottom plan view thereof.

The broken lines showing a wine glass and a cushion in FIG. 1 are included for the purpose of illustrating the invention in use, and form no part of the claimed design.

**1 Claim, 5 Drawing Sheets**

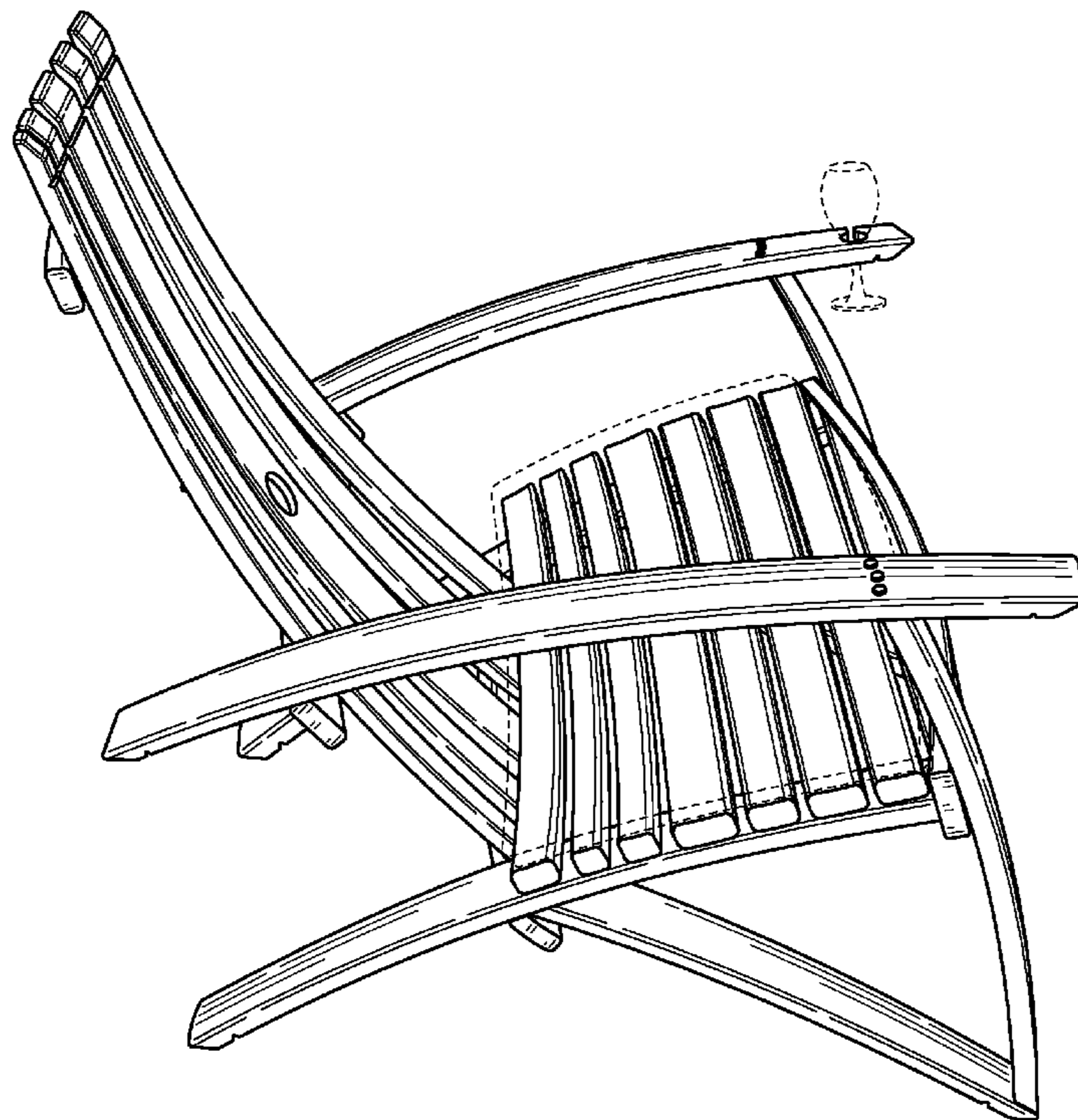

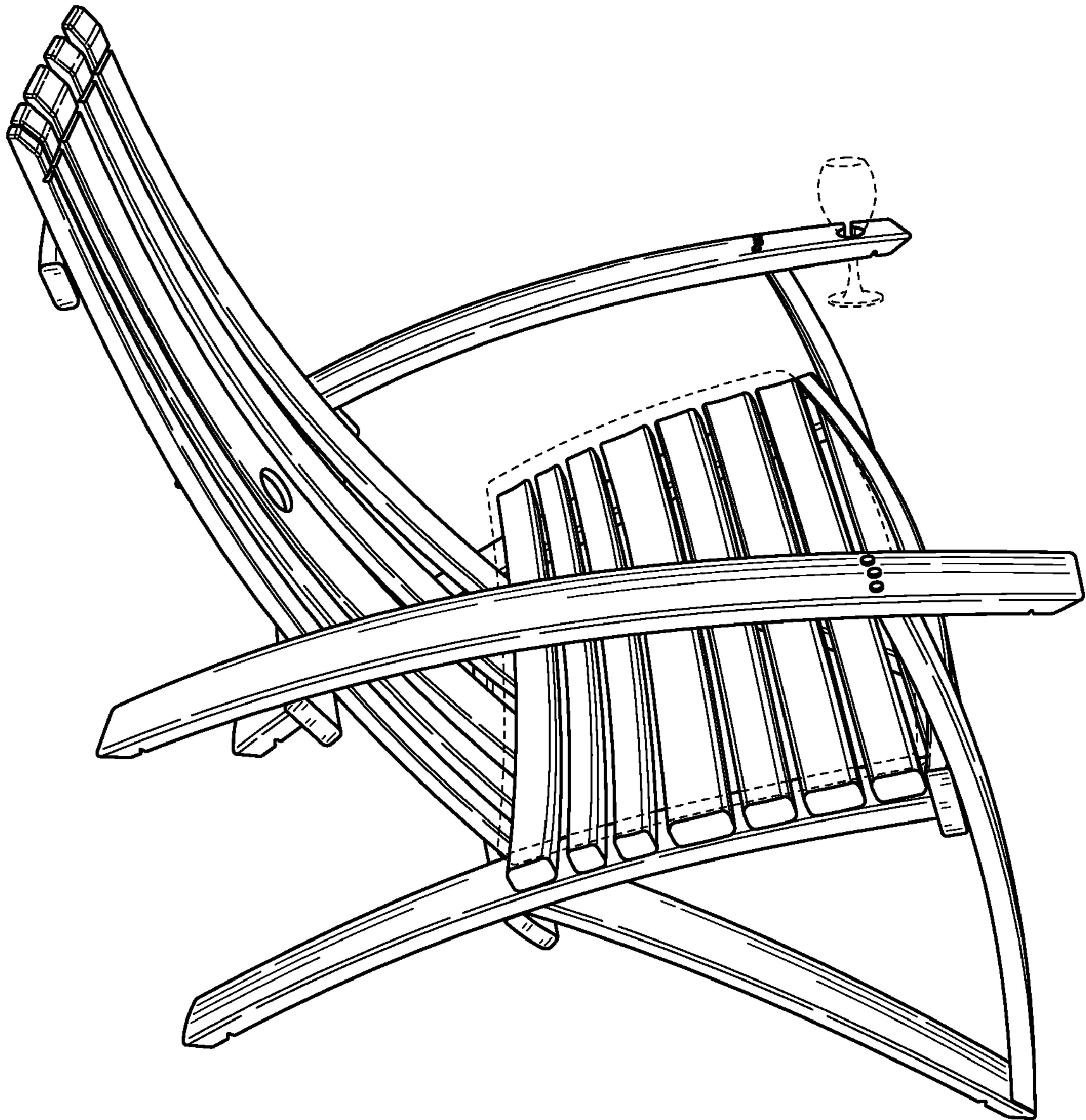

FIG. 1

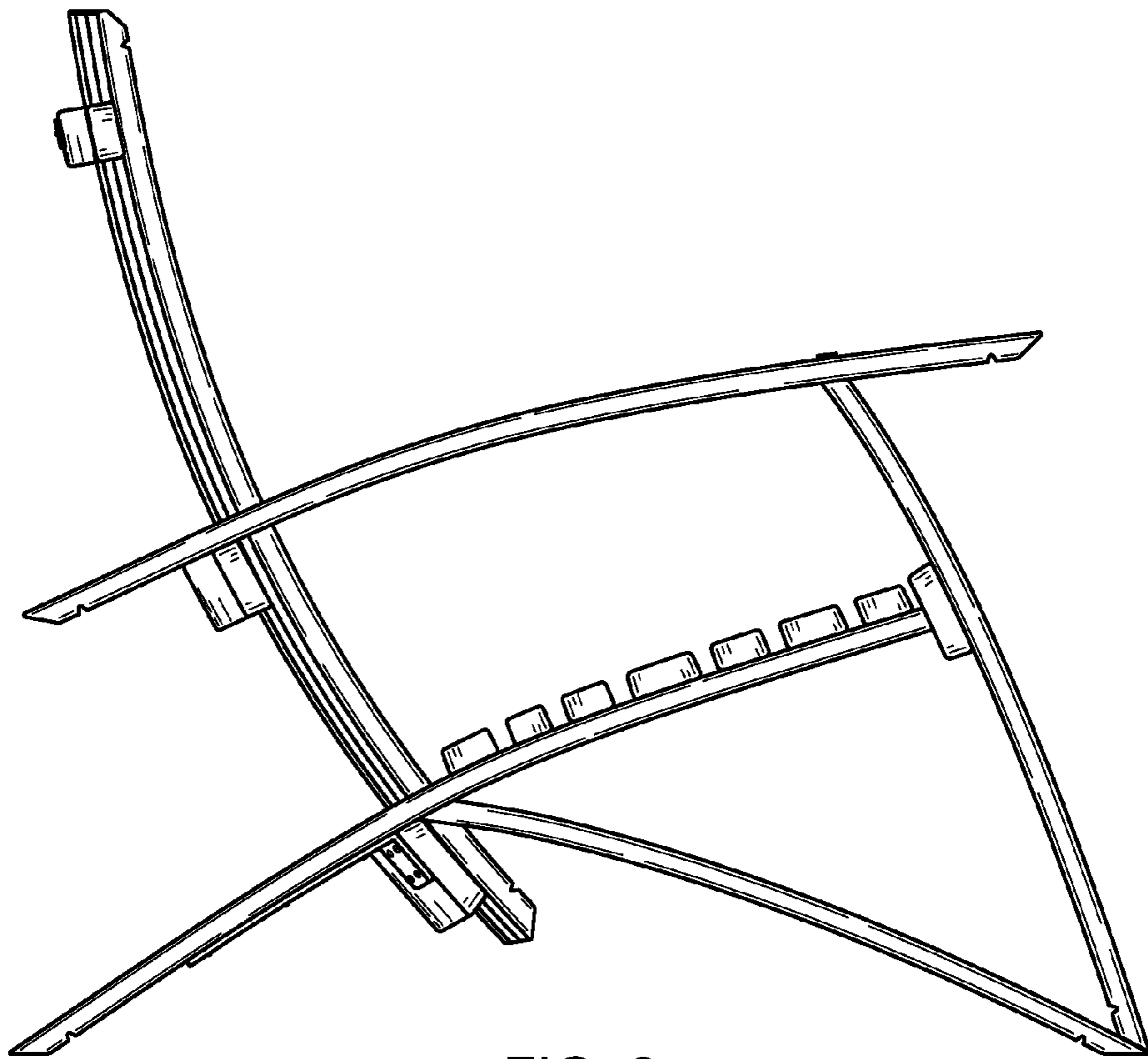

FIG. 2

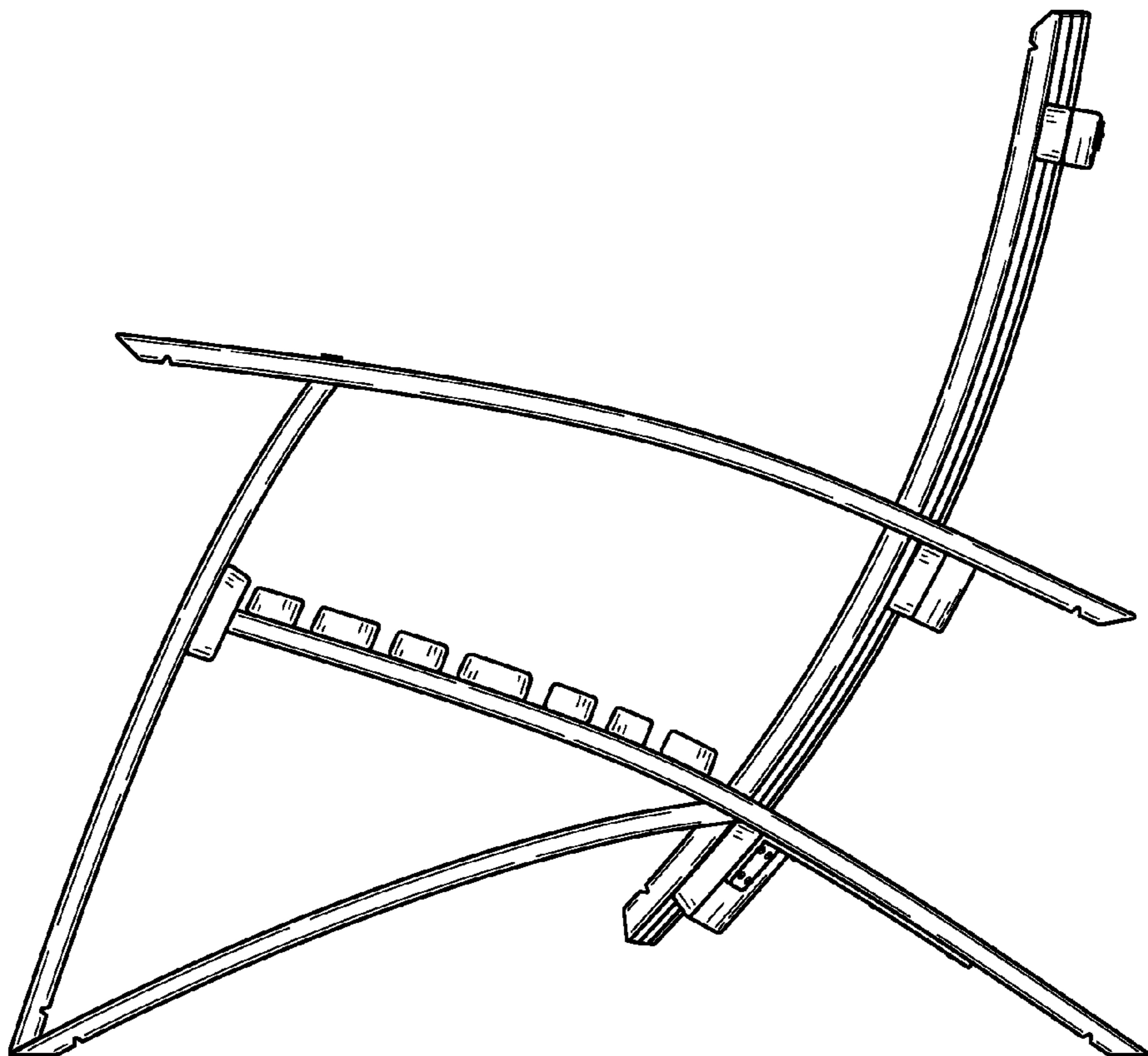

FIG. 3

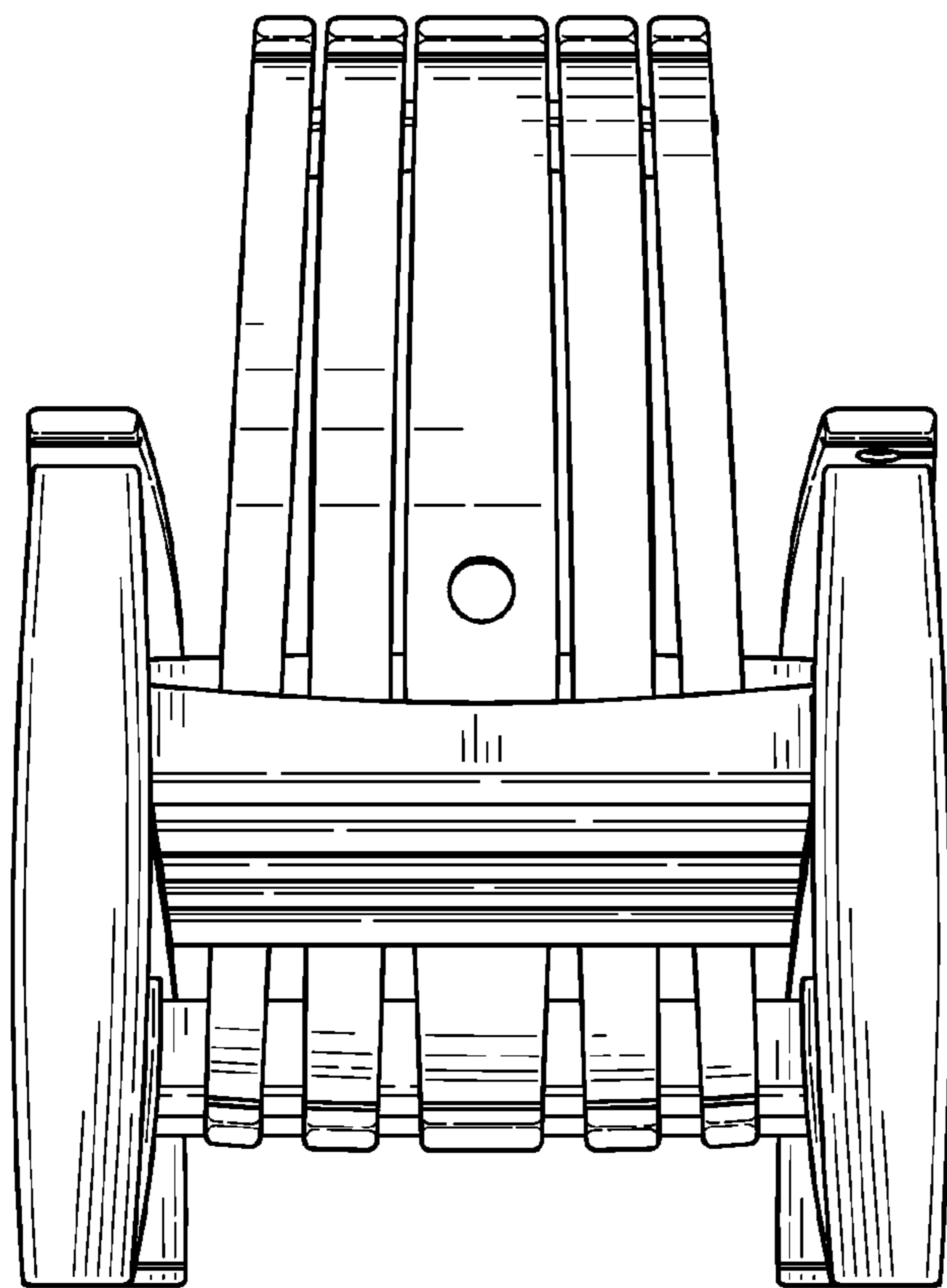

FIG. 4

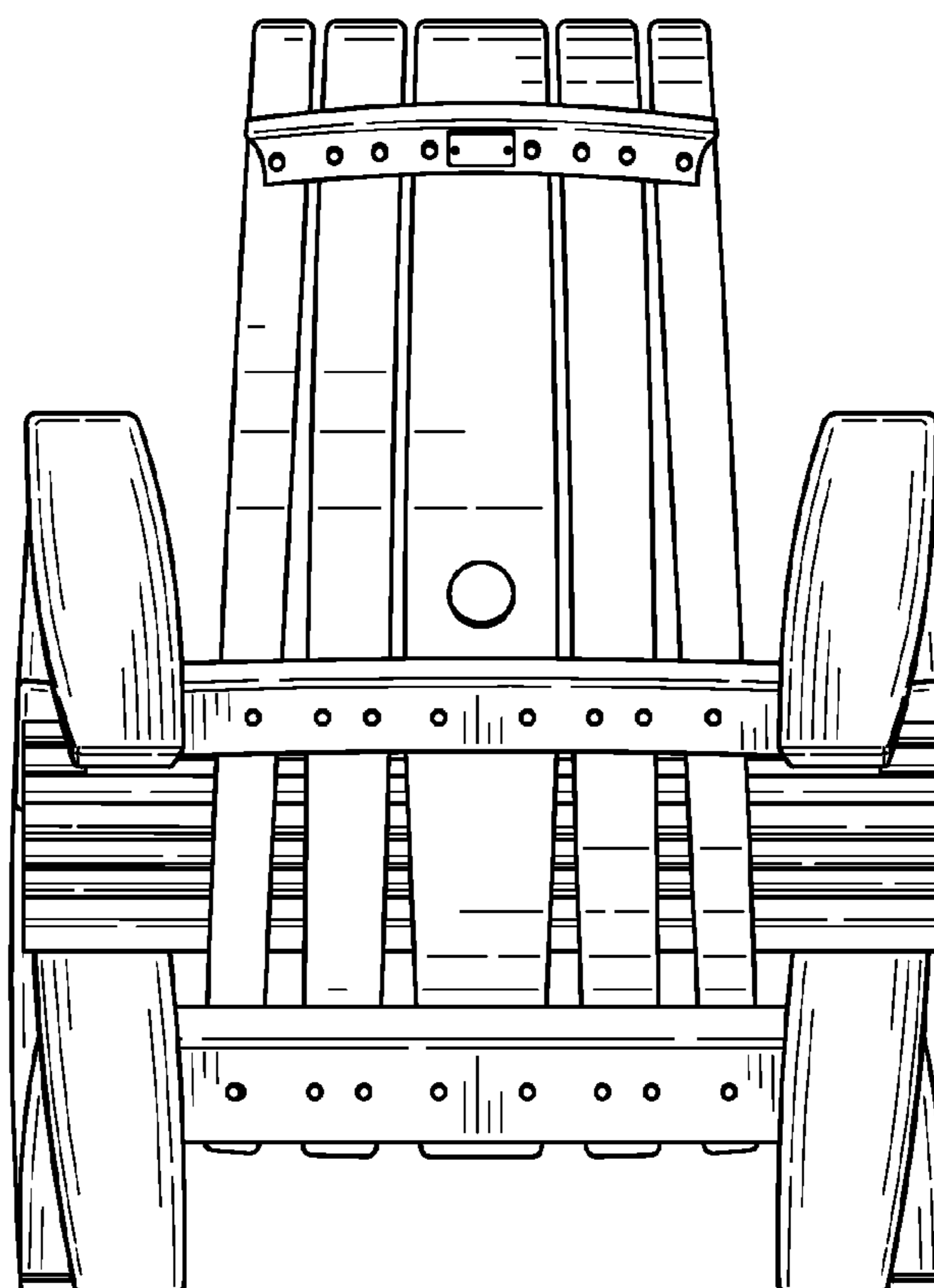

FIG. 5

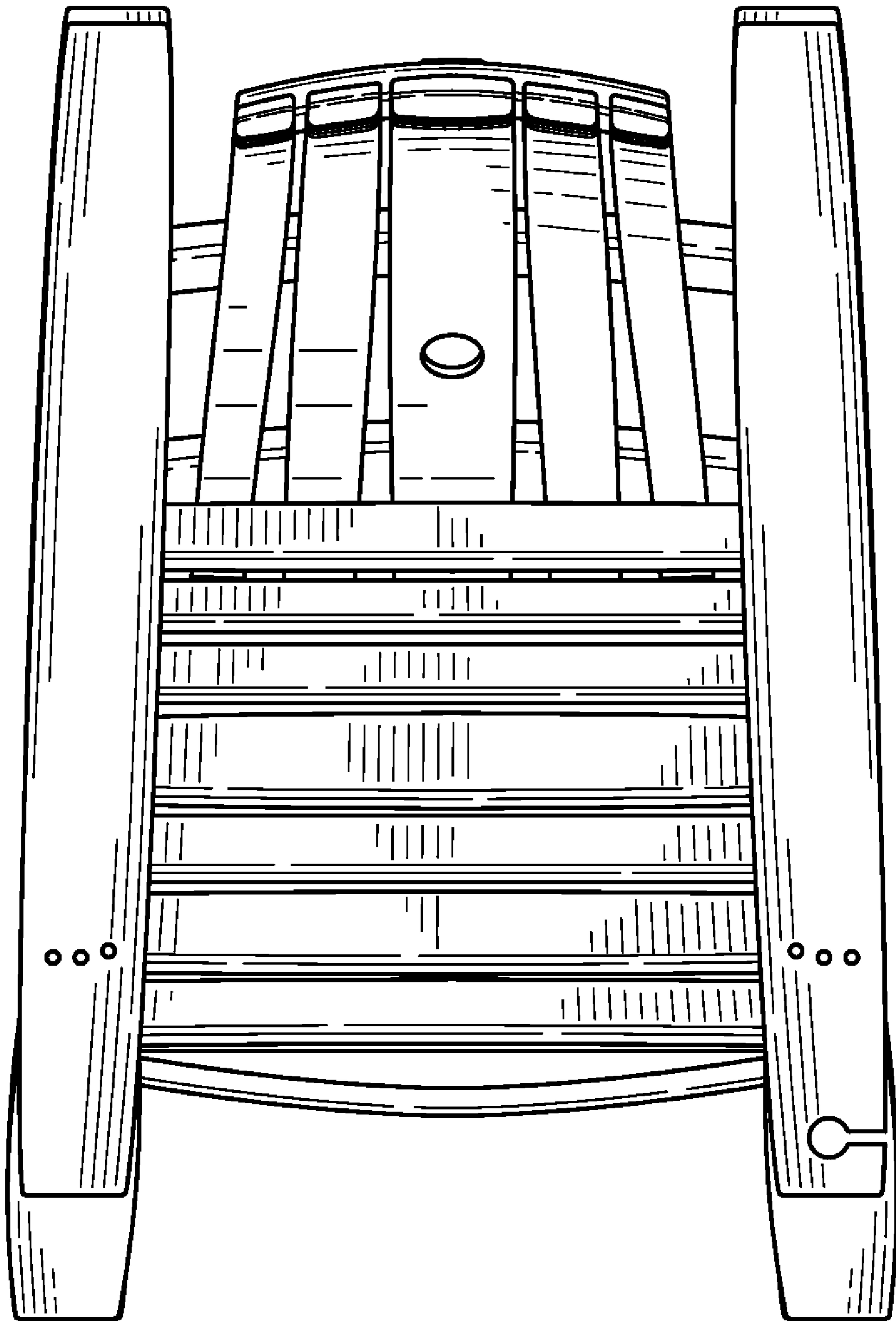

FIG. 6

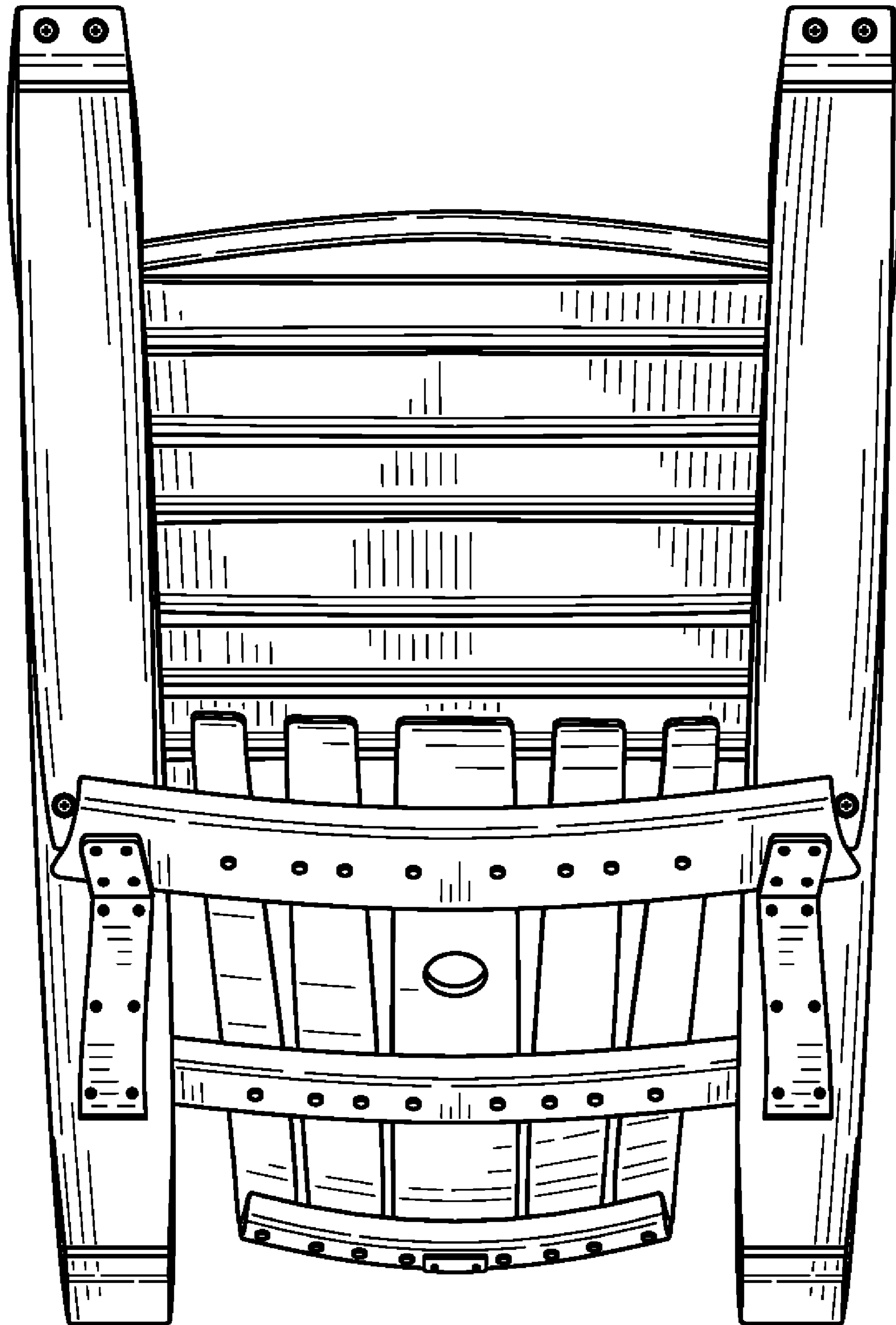

FIG. 7