



US00D615273S

(12) **United States Design Patent**
Magee

(10) **Patent No.:** **US D615,273 S**

(45) **Date of Patent:** **** May 4, 2010**

(54) **RAIN BARREL**

(76) Inventor: **Patrick B. Magee**, 2945 Crosswycke
Forest Cir., Atlanta, GA (US) 30319

(**) Term: **14 Years**

(21) Appl. No.: **29/306,102**

(22) Filed: **Apr. 2, 2008**

(51) **LOC (9) Cl.** **09-02**

(52) **U.S. Cl.** **D34/39; D23/202**

(58) **Field of Classification Search** D34/1,
D34/7, 8, 39; D23/200, 202, 203, 205; 220/565,
220/908, 908.1; D11/143, 152, 153, 154;
D7/558, 565, 584

See application file for complete search history.

(56) **References Cited**

U.S. PATENT DOCUMENTS

D85,918 S *	1/1932	Dugdale	D11/153
D85,919 S *	1/1932	Dugdale	D11/153
2,005,247 A *	6/1935	Thompson	220/592.19
D185,488 S *	6/1959	Burck et al.	D34/1
D195,664 S *	7/1963	Wilson	D7/313
3,704,808 A *	12/1972	Gibson et al.	206/519
D239,505 S *	4/1976	Ward	D34/39
D295,108 S *	4/1988	Przytulla	D34/39
D335,744 S *	5/1993	Small et al.	D34/39
D349,944 S *	8/1994	Harris	D23/202
D374,959 S *	10/1996	Mull	D34/39
D395,118 S *	6/1998	Cramer et al.	D34/39
D406,081 S *	2/1999	Antonio	D11/143
D454,467 S *	3/2002	Magermans et al.	D7/313
D463,615 S *	9/2002	Habibi et al.	D27/138

D526,110 S *	8/2006	Wentzel	D34/39
D542,707 S *	5/2007	Kolokotronis et al.	D11/153
D542,885 S *	5/2007	Knackstedt	D23/202
D560,874 S *	1/2008	Brans	D34/39
D599,975 S *	9/2009	Magee	D34/39
D604,475 S *	11/2009	Bender et al.	D34/39
D605,375 S *	12/2009	Anderson et al.	D34/39
D607,625 S *	1/2010	Landry	D34/5

* cited by examiner

Primary Examiner—Cynthia E Ramirez

(74) *Attorney, Agent, or Firm*—Baker Donelson, et al.;
Warner J. Delaune

(57) **CLAIM**

I claim the ornamental design for a rain barrel, as shown and described.

DESCRIPTION

FIG. 1 is a perspective view of one embodiment of a rain barrel showing my new design;

FIG. 2 is a front elevation view thereof;

FIG. 3 is a rear elevation view thereof;

FIG. 4 is a left elevation view thereof;

FIG. 5 is a right elevation view thereof;

FIG. 6 is a top view thereof; and,

FIG. 7 is a bottom view thereof.

The broken line showing of some elements in the figures is included for the purpose of illustrating environment and forms no part of the claimed design.

1 Claim, 4 Drawing Sheets

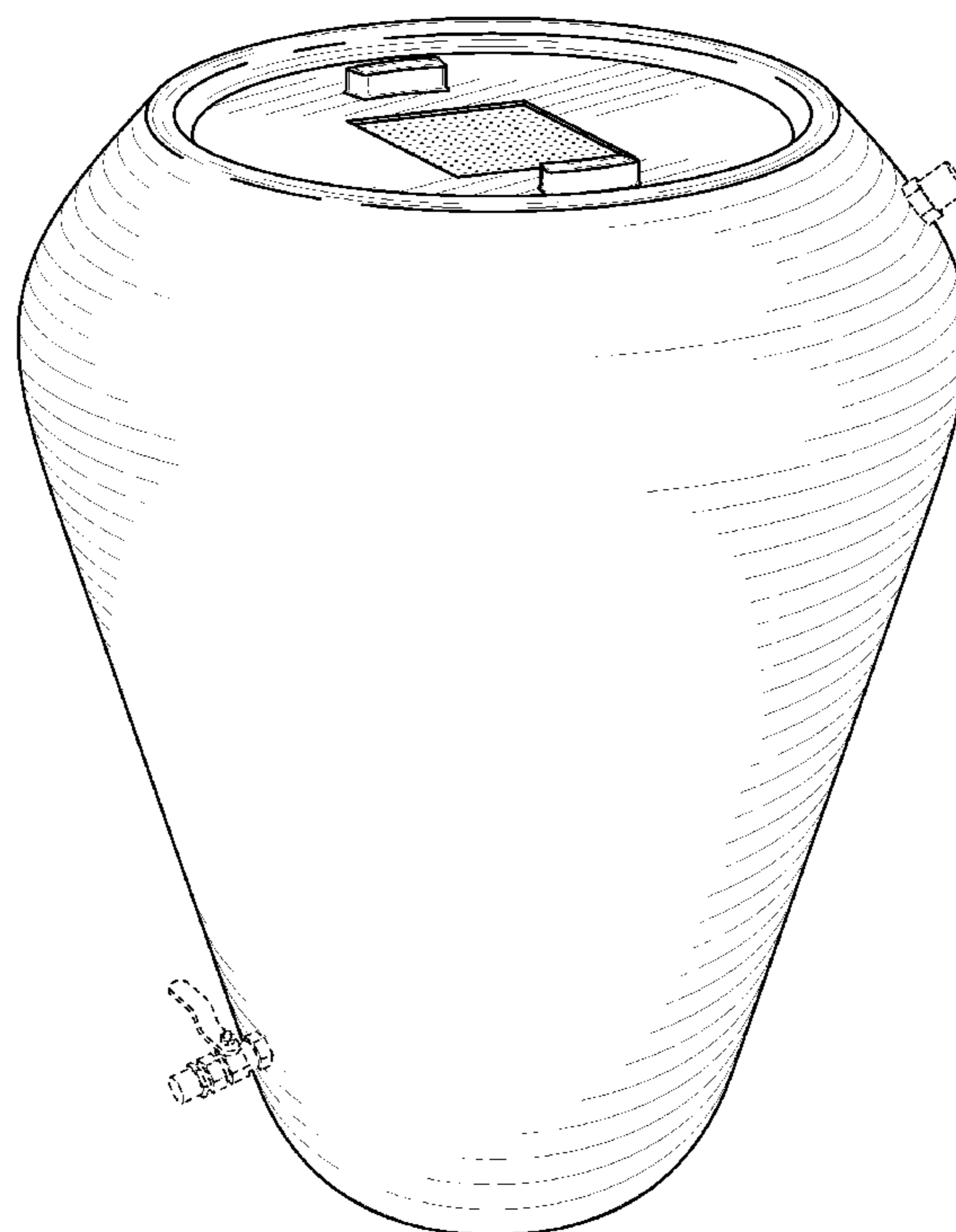

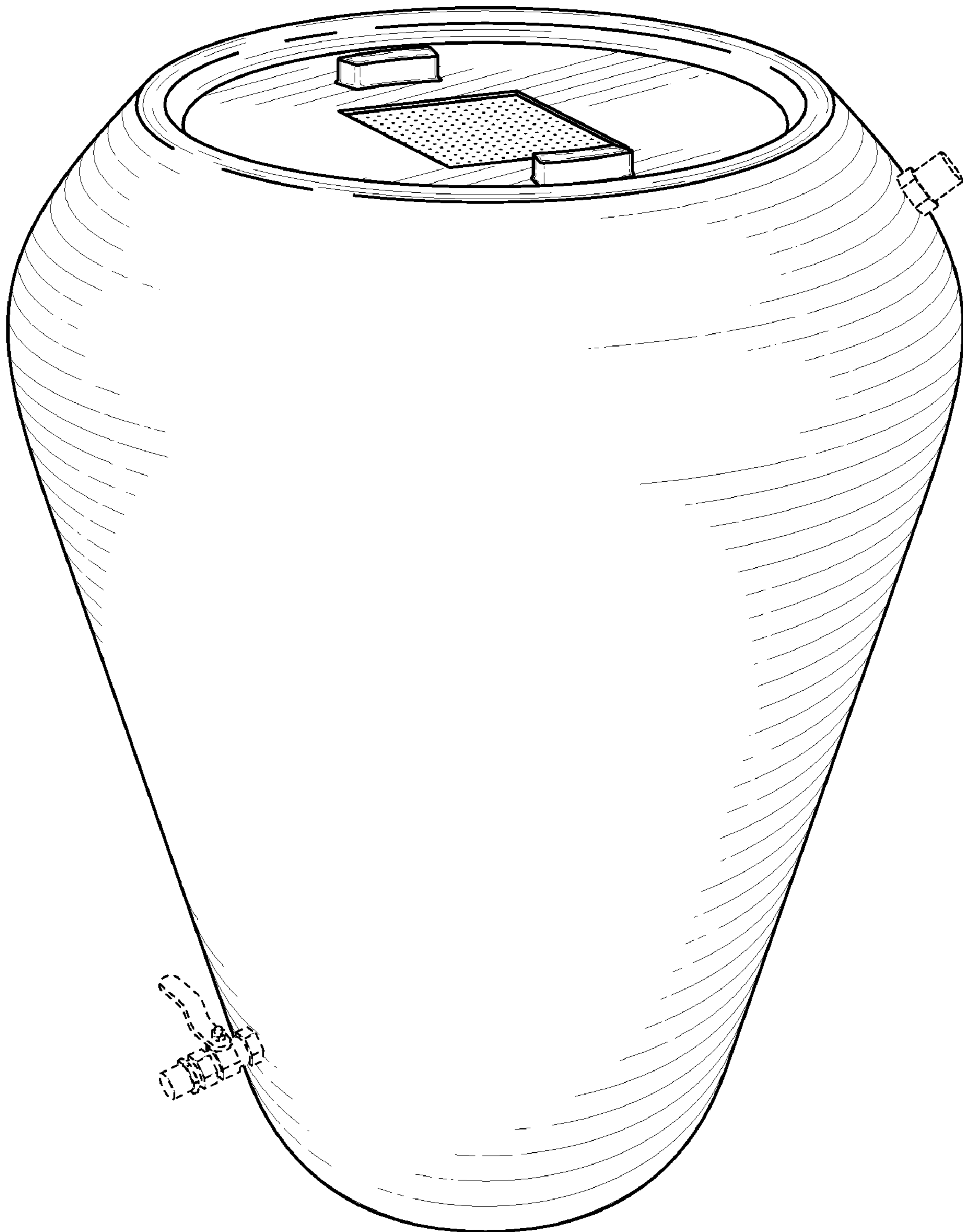

FIG. 1

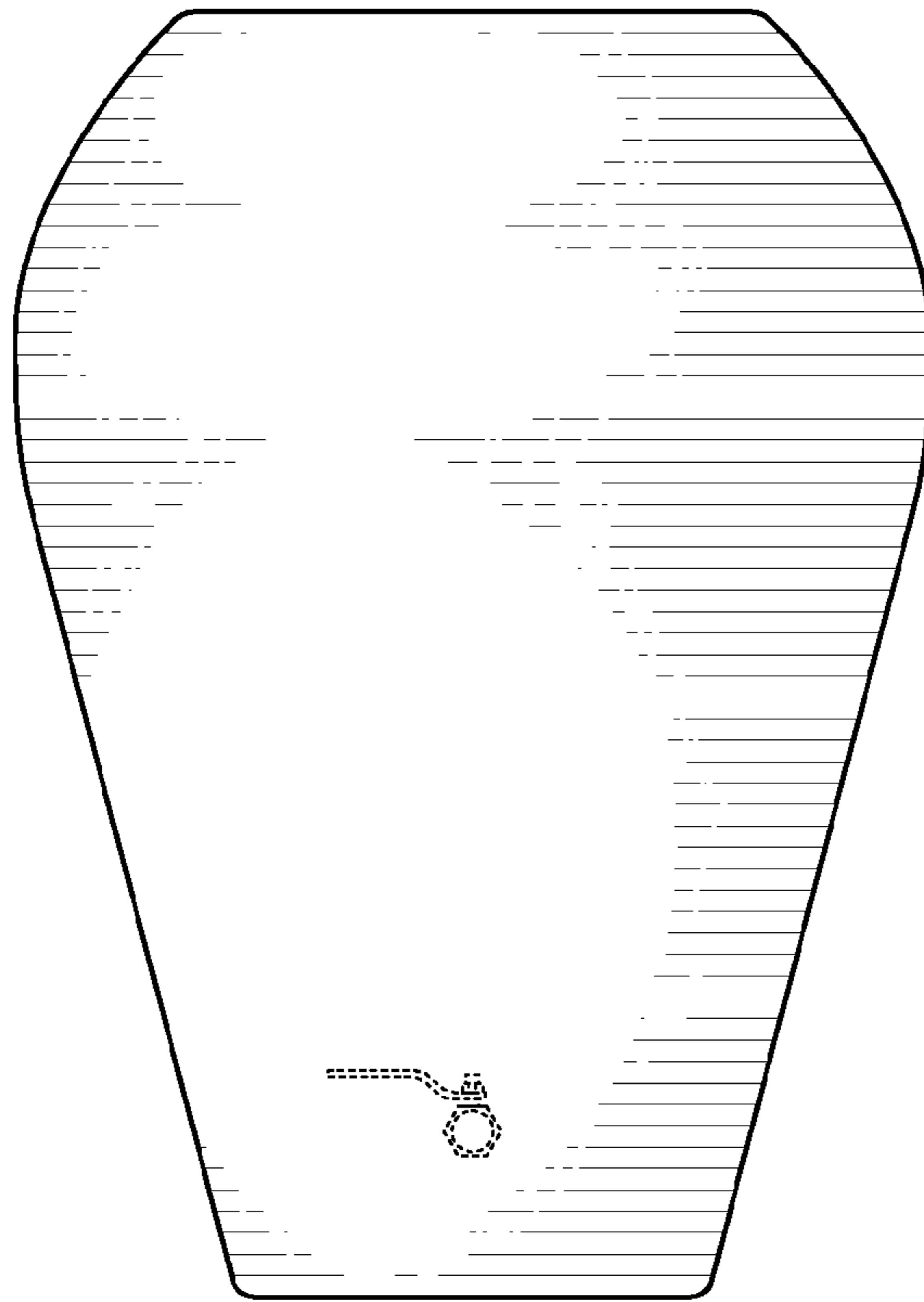

FIG. 2

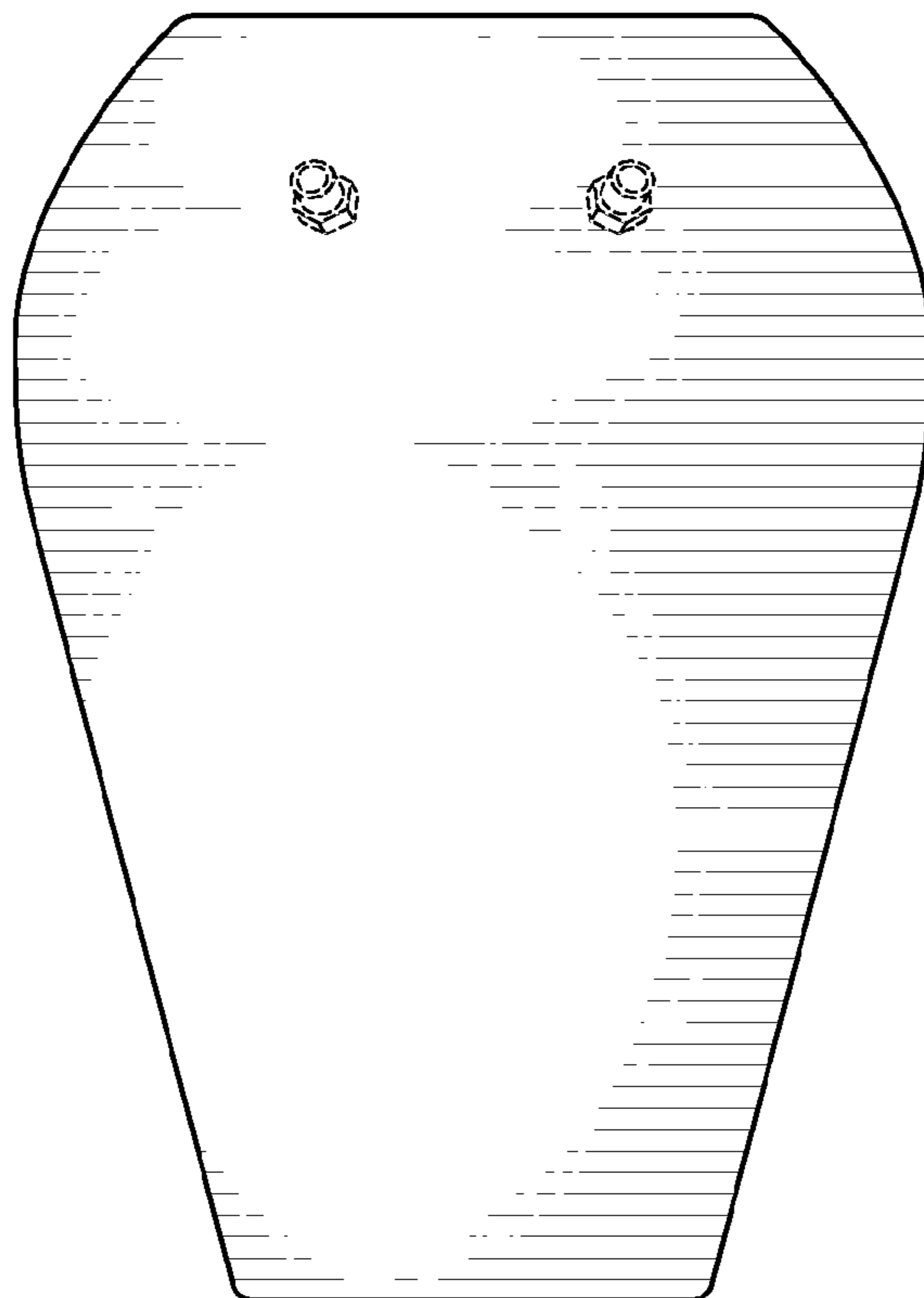

FIG. 3

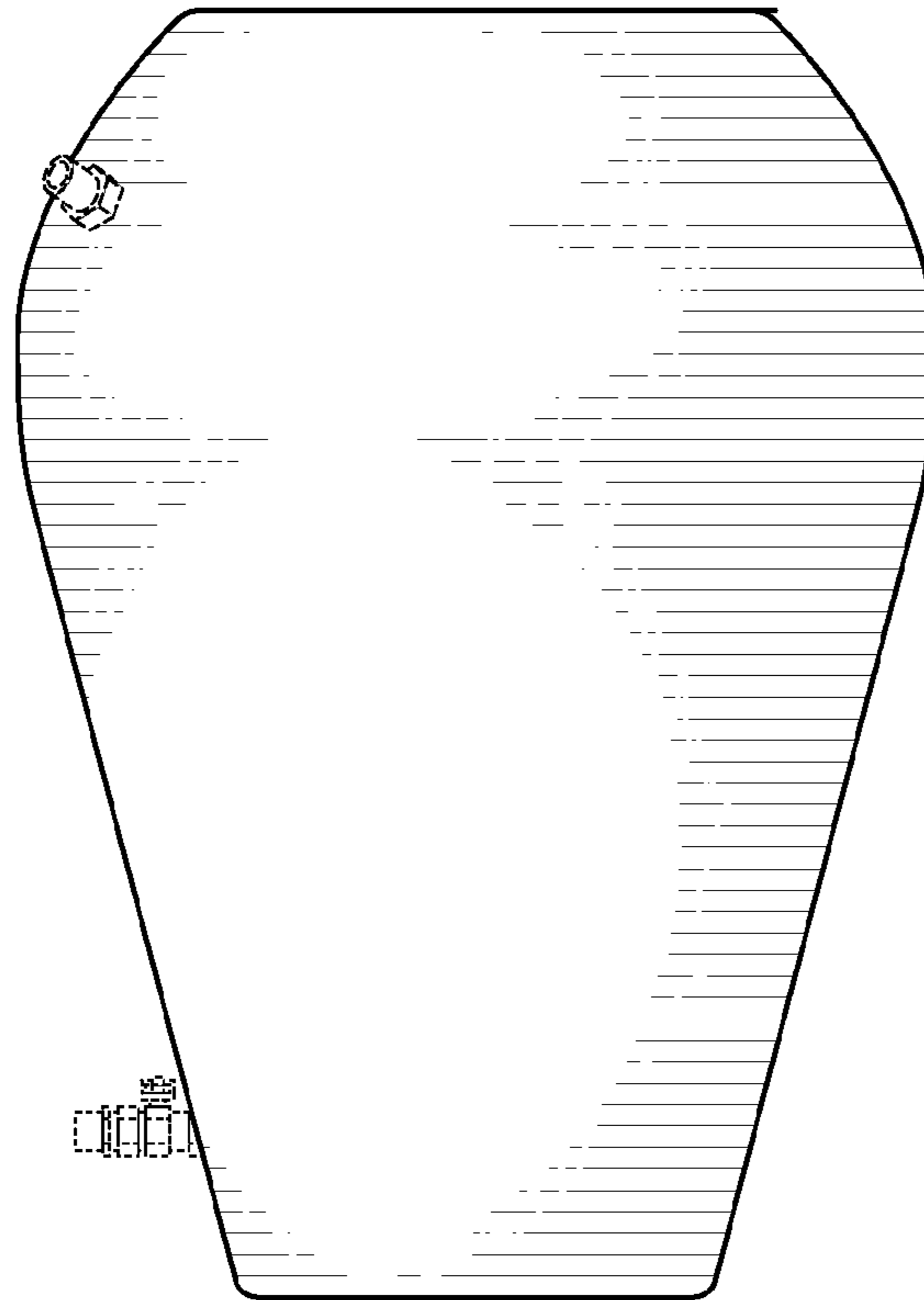

FIG. 4

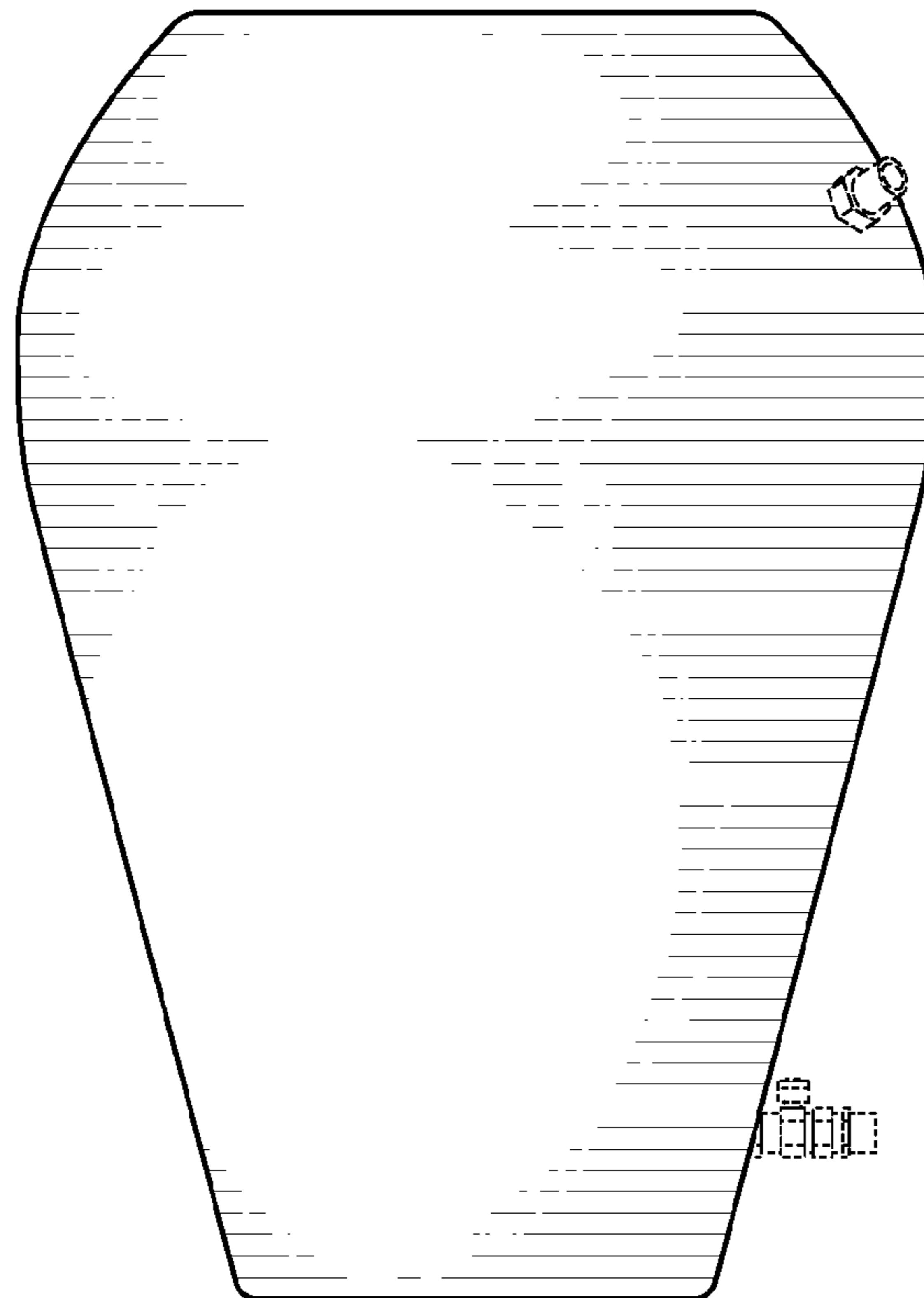

FIG. 5

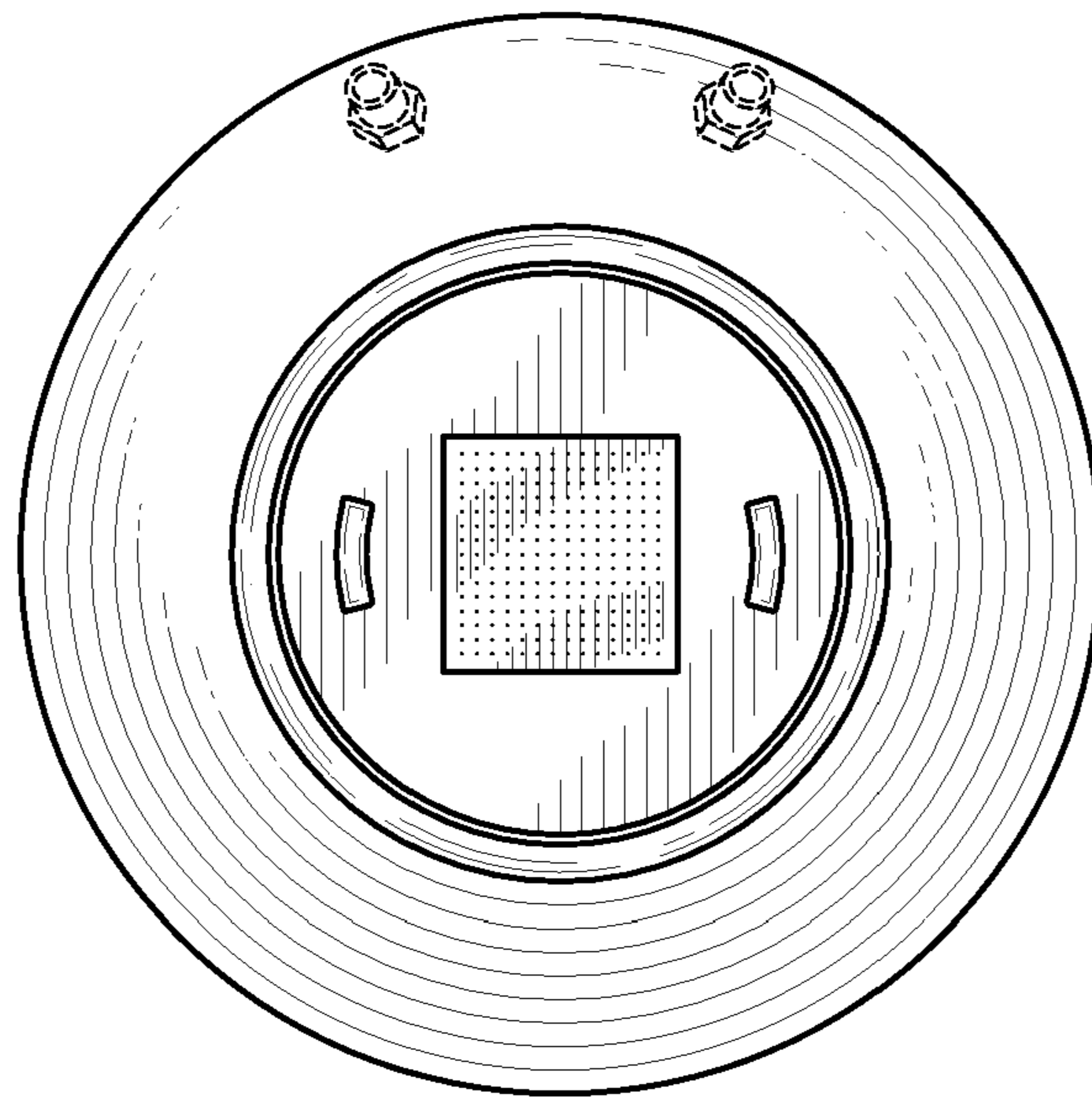

FIG. 6

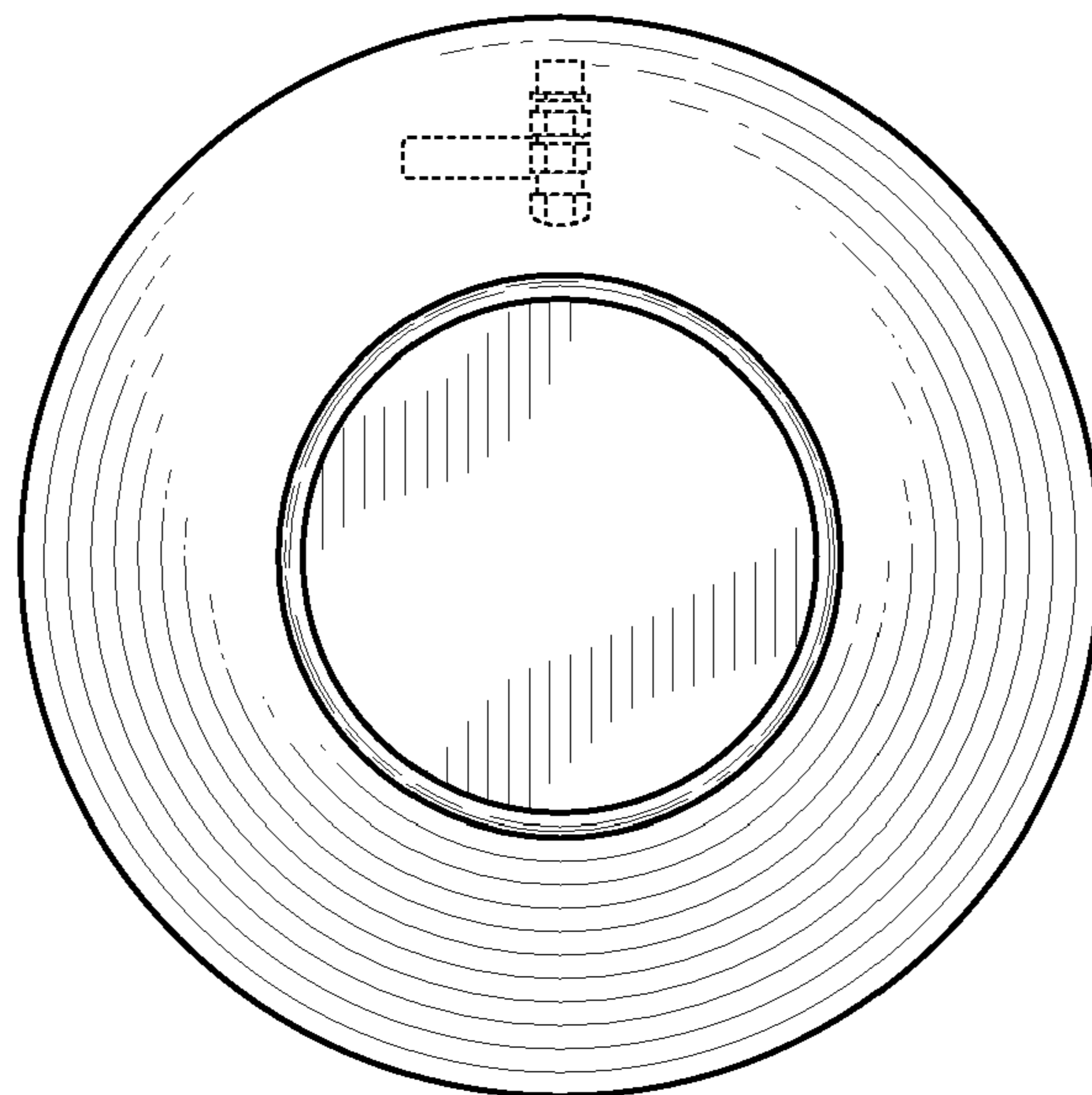

FIG. 7