



US00D615214S

(12) **United States Design Patent**
Lynch et al.

(10) **Patent No.:** **US D615,214 S**
(45) **Date of Patent:** **** May 4, 2010**

(54) **DOOR FACING**

DESCRIPTION

(75) Inventors: **Steven K. Lynch**, St. Charles, IL (US);
Gregory J. Wysock, Sycamore, IL (US);
Hallie L. Heuser, Geneva, IL (US)

(73) Assignee: **Masonite Corporation**, Tampa, FL (US)

(**) Term: **14 Years**

(21) Appl. No.: **29/339,682**

(22) Filed: **Jul. 6, 2009**

Related U.S. Application Data

(63) Continuation of application No. 29/318,084, filed on May 13, 2008, now abandoned.

(51) **LOC (9) Cl.** **25-02**

(52) **U.S. Cl.** **D25/48**

(58) **Field of Classification Search** D25/48;
52/455, 456, 311.1; 49/DIG. 2, 504
See application file for complete search history.

(56) **References Cited**

U.S. PATENT DOCUMENTS

4,006,571	A *	2/1977	Bursk	52/802.11
D460,564	S *	7/2002	Ben-Ezra	D25/48
D495,062	S *	8/2004	Lynch et al.	D25/48
2005/0102908	A1 *	5/2005	Martin	49/455

* cited by examiner

Primary Examiner—Doris Clark

(74) *Attorney, Agent, or Firm*—Berenato & White, LLC

(57) **CLAIM**

The ornamental design for a door facing, as shown and described.

FIG. 1 is a front perspective view of a first embodiment of our design;

FIG. 2 is a front elevational view thereof;

FIG. 3 is a rear elevational view;

FIG. 4 is a top plan view;

FIG. 5 is a bottom plan view;

FIG. 6 is a cross-sectional view taken along the line 6—6 of FIG. 2 and viewed in the direction of the arrows;

FIG. 7 is an enlarged fragmented right side cross-sectional view of FIG. 6;

FIG. 8 is a left side elevational view;

FIG. 9 is a right side elevational view; and

FIG. 10 is a cross-sectional view taken along the line 10—10 of FIG. 2 and viewed in the direction of the arrows;

FIG. 11 is a front perspective view of a second embodiment of our design;

FIG. 12 is a front elevational view thereof;

FIG. 13 is a rear elevational view;

FIG. 14 is a top plan view;

FIG. 15 is a bottom plan view;

FIG. 16 is a cross-sectional view taken along the line 16—16 of FIG. 12 and viewed in the direction of the arrows;

FIG. 17 is an enlarged fragmented right side cross-sectional view of FIG. 16;

FIG. 18 is a left side elevational view;

FIG. 19 is a right side elevational view; and,

FIG. 20 is a cross-sectional view taken along the line 20—20 of FIG. 12 and viewed in the direction of the arrows.

1 Claim, 10 Drawing Sheets

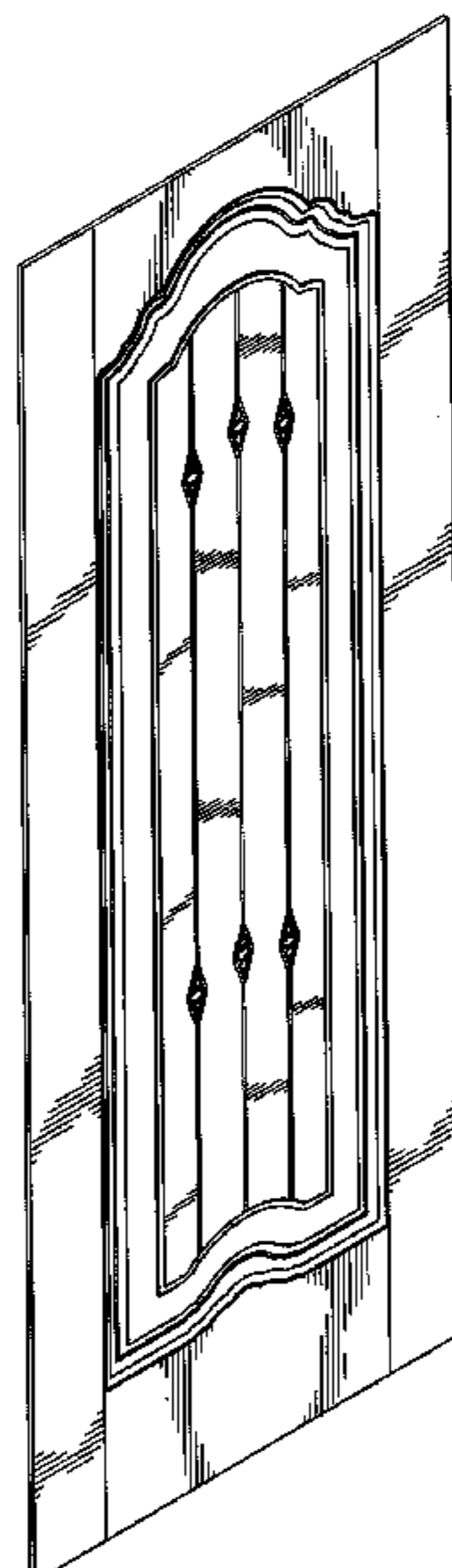
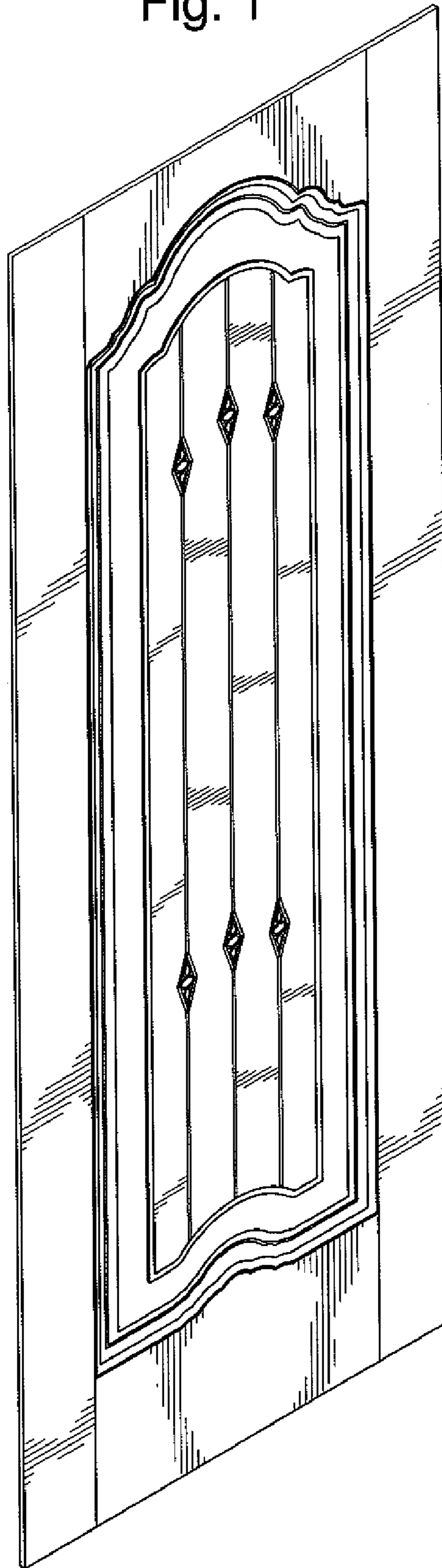

Fig. 1



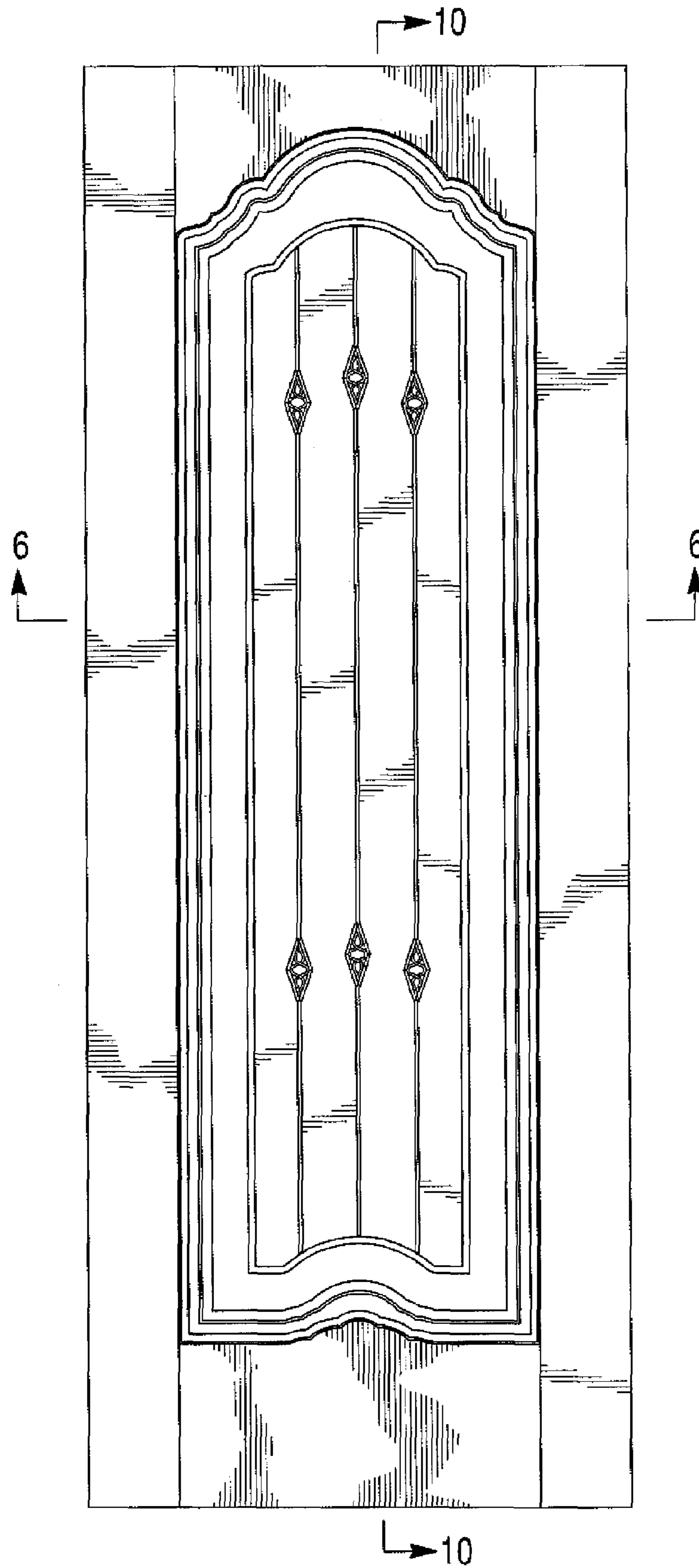

Fig. 2

Fig. 3

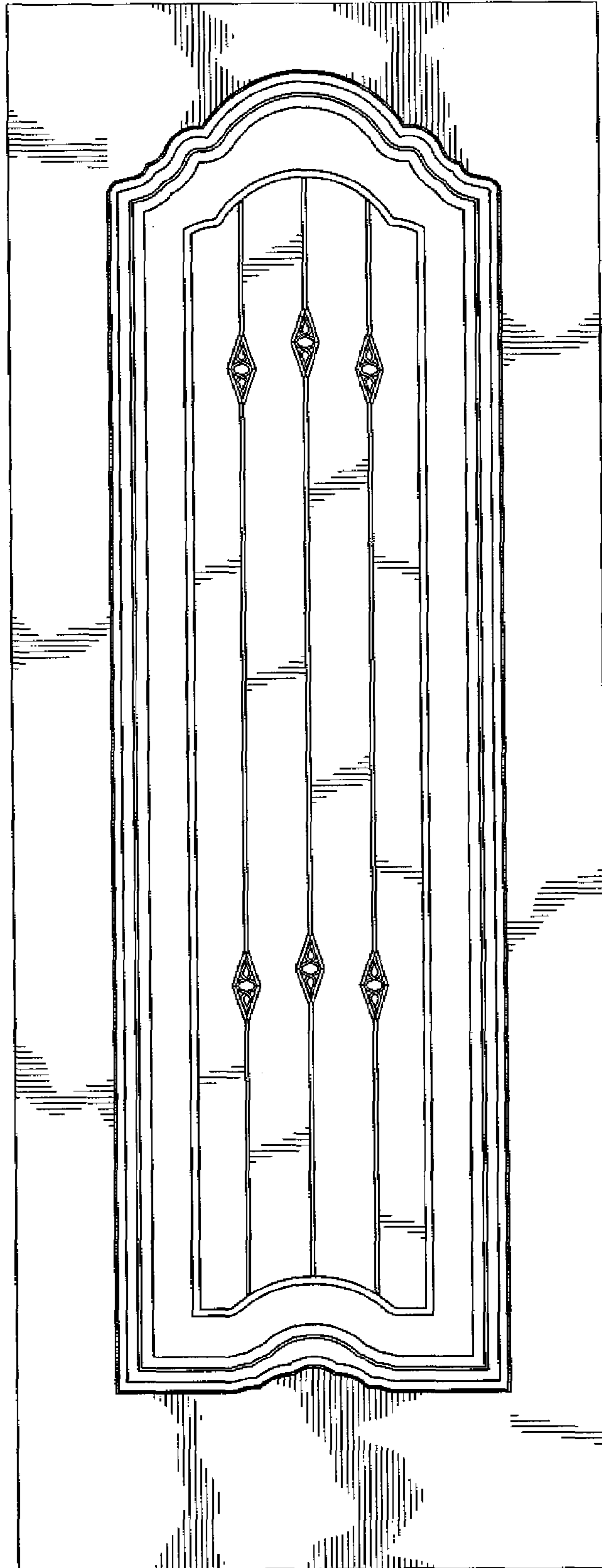

Fig. 4

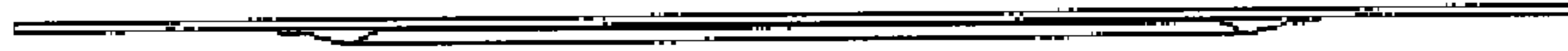

Fig. 5



Fig. 6

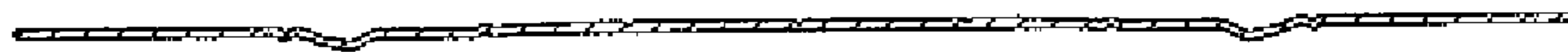

Fig. 7



Fig. 8



Fig. 9



Fig. 10



Fig. 11

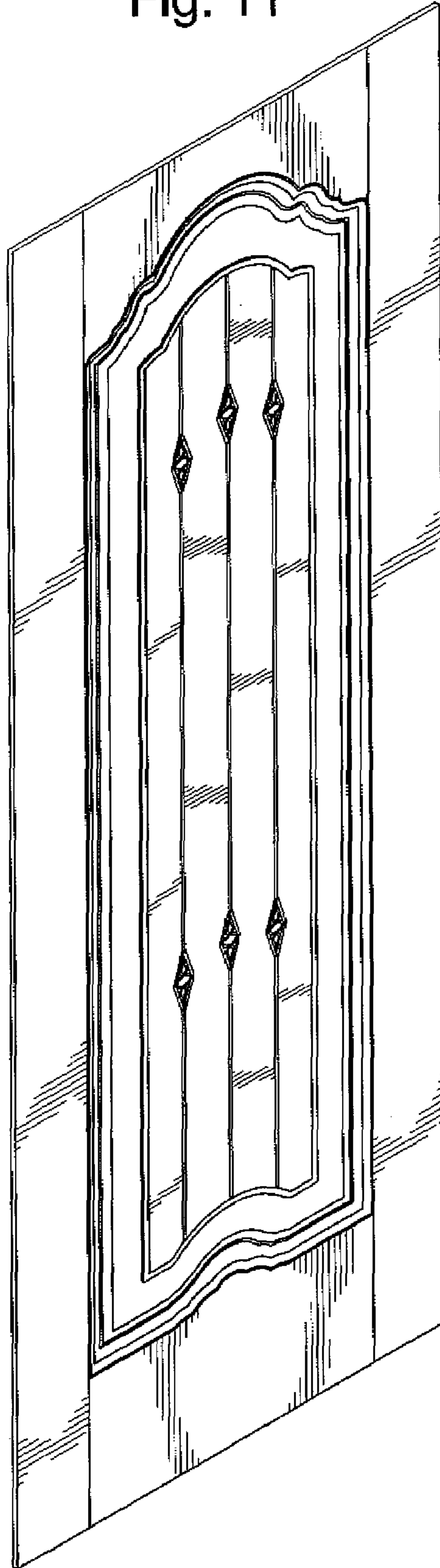

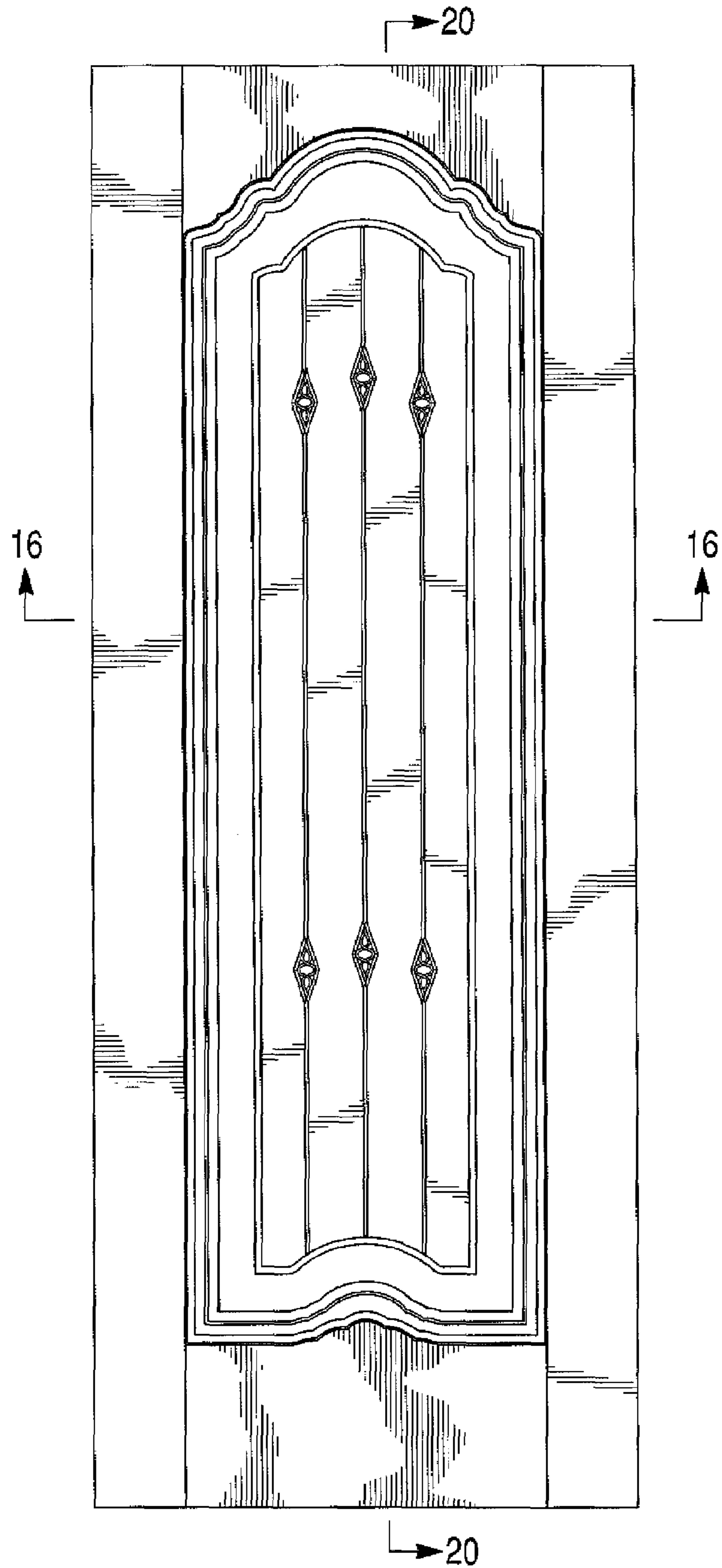

Fig. 12

Fig. 13

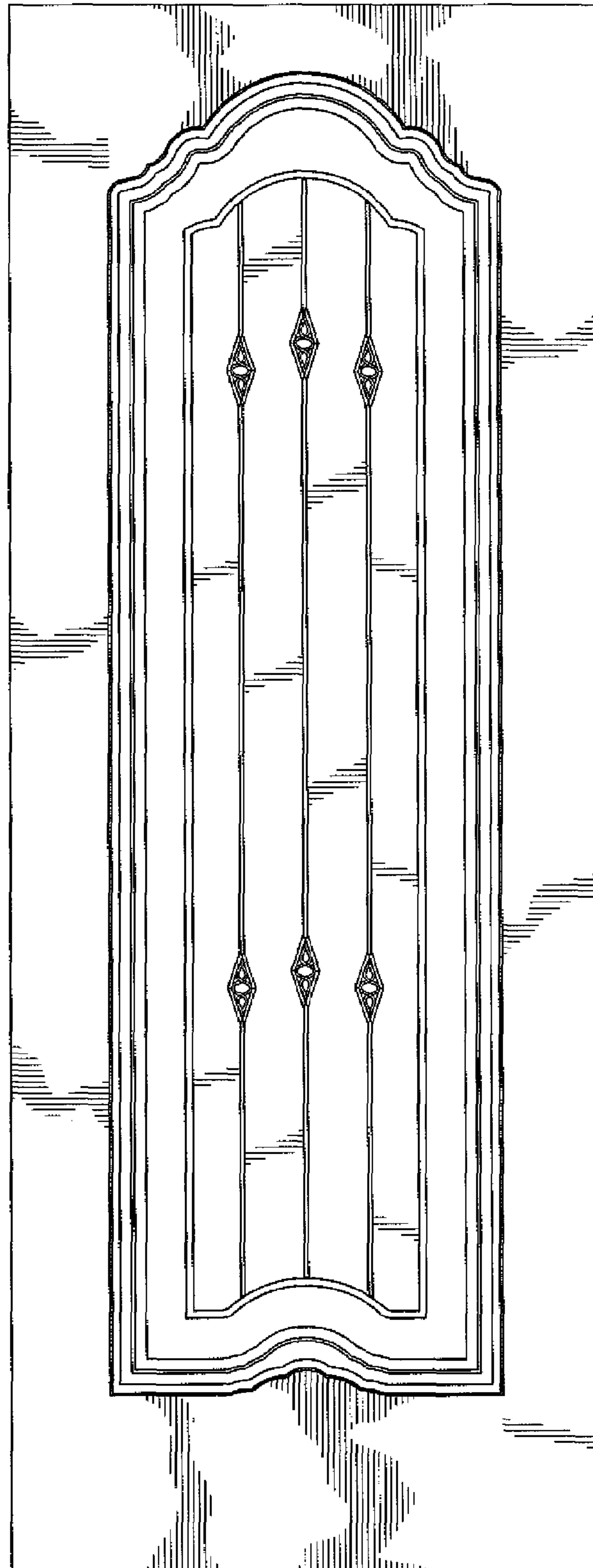

Fig. 14

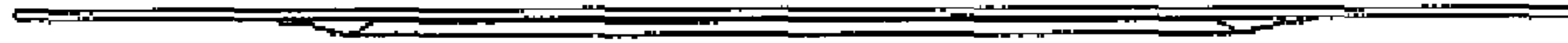

Fig. 15



Fig. 16

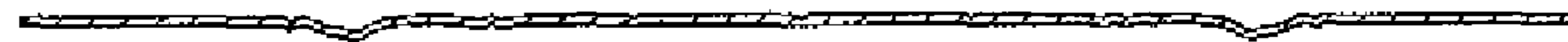

Fig. 17

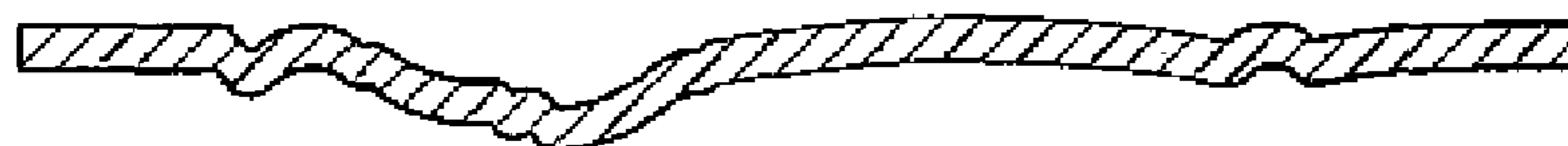

Fig. 18



Fig. 19



Fig. 20

