



US00D615067S

(12) **United States Design Patent**
Wilson

(10) **Patent No.:** **US D615,067 S**

(45) **Date of Patent:** **** May 4, 2010**

(54) **SOUND GENERATING DEVICE**

(57) **CLAIM**

(76) Inventor: **Scott Wilson**, 836 N. Paulina #301,
Chicago, IL (US) 60622

The ornamental design for a sound generating device, as shown.

(**) Term: **14 Years**

DESCRIPTION

(21) Appl. No.: **29/330,470**

(22) Filed: **Jan. 8, 2009**

(51) **LOC (9) Cl.** **14-01**

(52) **U.S. Cl.** **D14/215; D14/167**

(58) **Field of Classification Search** .. D14/203.1-203.8,
D14/204, 210-216, 167, 168, 172, 217; 181/143-144,
181/147-148, 150-153, 157, 159, 198-199;
381/300-303, 306, 332-333, 336, 340, 343,
381/345, 361-364, 386-388

See application file for complete search history.

FIG. 1 is a perspective front view of a sound-generating device showing my new design;

FIG. 2 is a perspective rear view thereof;

FIG. 3 is a front elevational view thereof;

FIG. 4 is a left side elevational view thereof;

FIG. 5 is a right side elevational view thereof;

FIG. 6 is a rear elevational view thereof;

FIG. 7 is a top plan view thereof;

FIG. 8 is a bottom plan view thereof;

FIG. 9 is a top front perspective view of a sound generating device showing another embodiment of my new design;

FIG. 10 is a top rear perspective view thereof;

FIG. 11 is a front elevational view thereof;

FIG. 12 is a left side elevational view thereof;

FIG. 13 is a right side elevational view thereof;

FIG. 14 is a rear elevational view thereof;

FIG. 15 is a top plan view thereof; and,

FIG. 16 is a bottom plan view thereof.

(56) **References Cited**

U.S. PATENT DOCUMENTS

D433,678 S	*	11/2000	Boucard	D14/167
D512,437 S	*	12/2005	Tierney	D14/203.6
D521,982 S	*	5/2006	Schafernak et al.	D14/218
D542,273 S	*	5/2007	Park et al.	D14/215
D543,536 S	*	5/2007	Hall	D14/215
D574,813 S	*	8/2008	Abate et al.	D14/216

* cited by examiner

Primary Examiner—Nanda Bondade

(74) *Attorney, Agent, or Firm*—Temmerman Law Office;
Mathew J. Temmerman

1 Claim, 12 Drawing Sheets

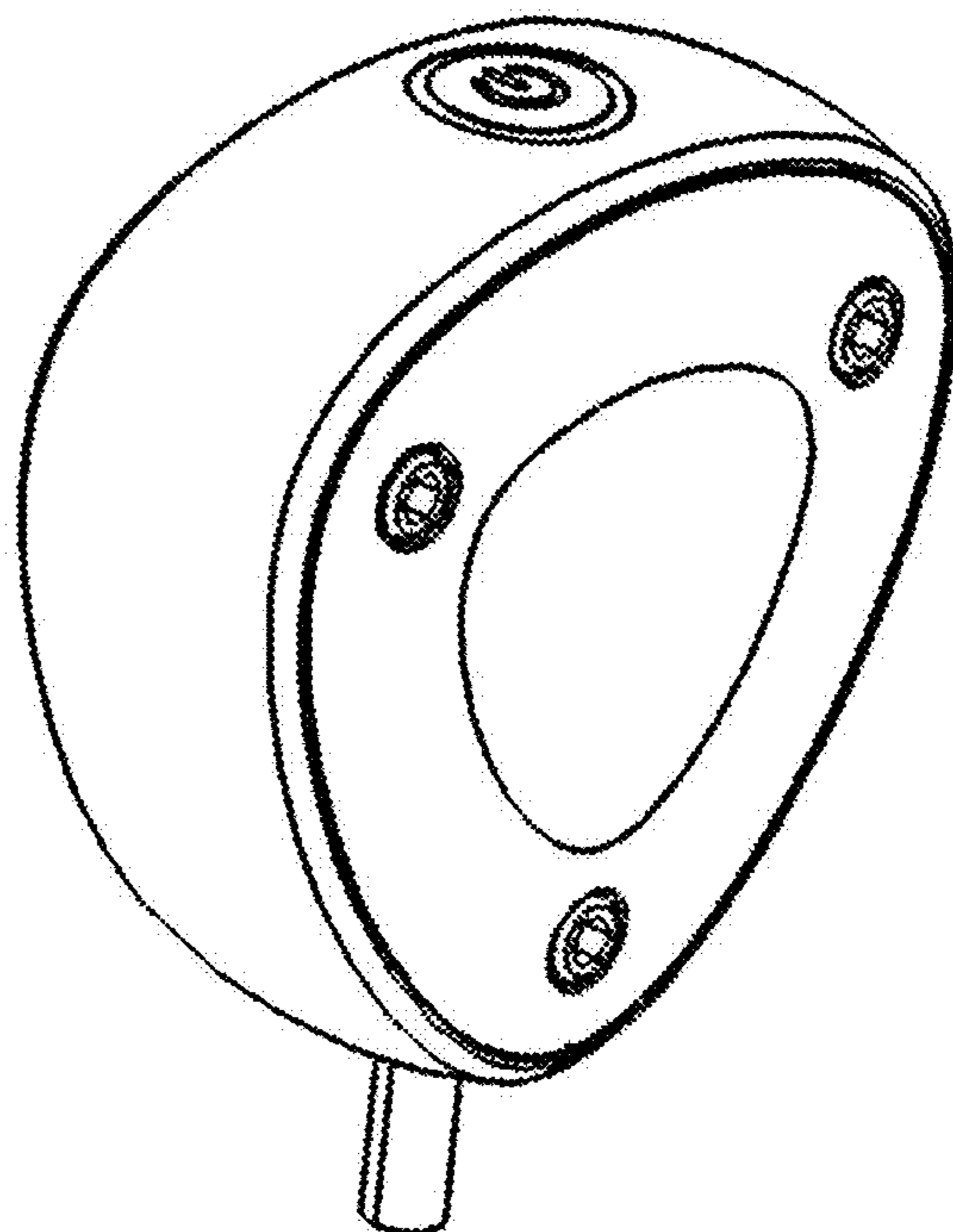
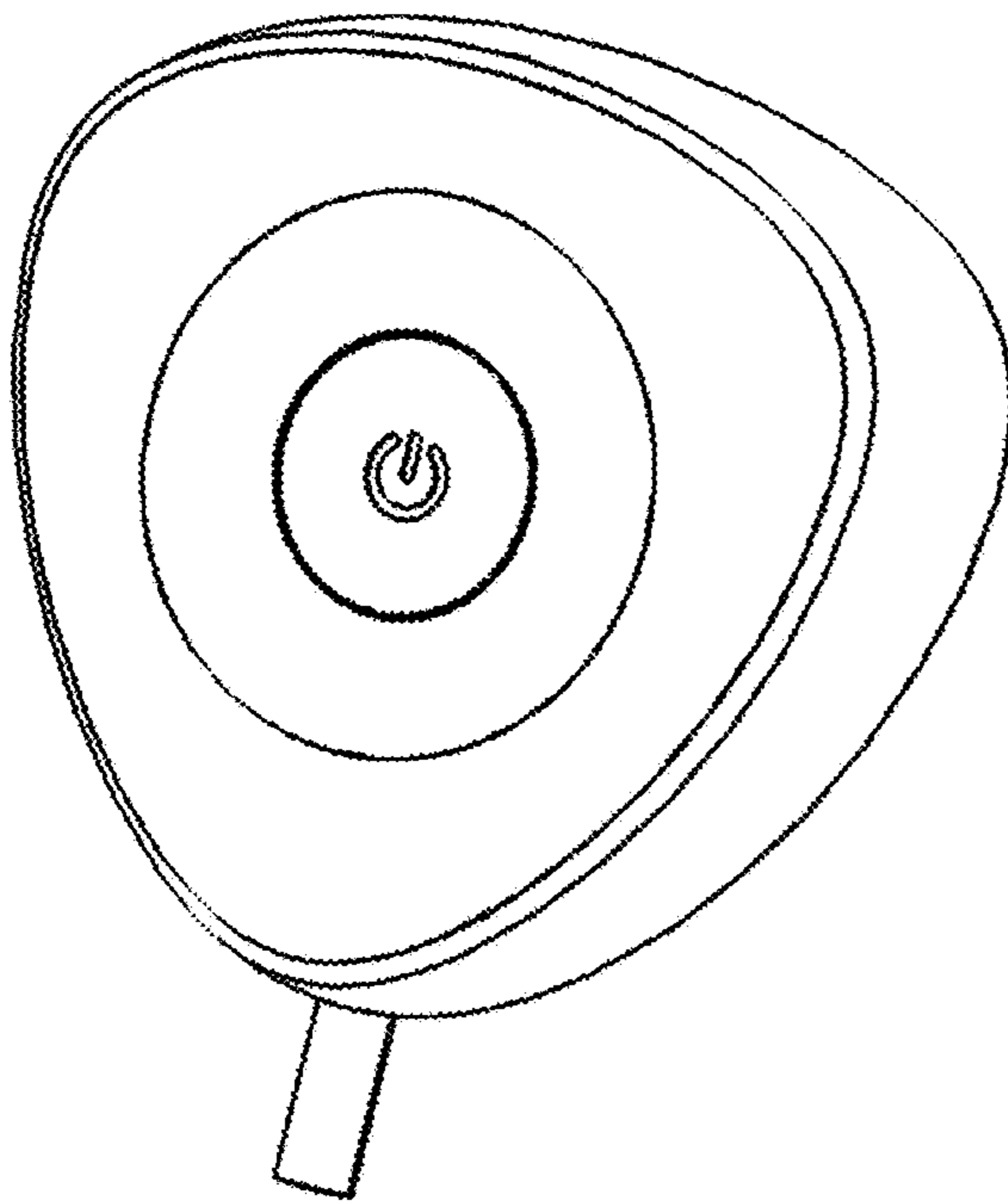

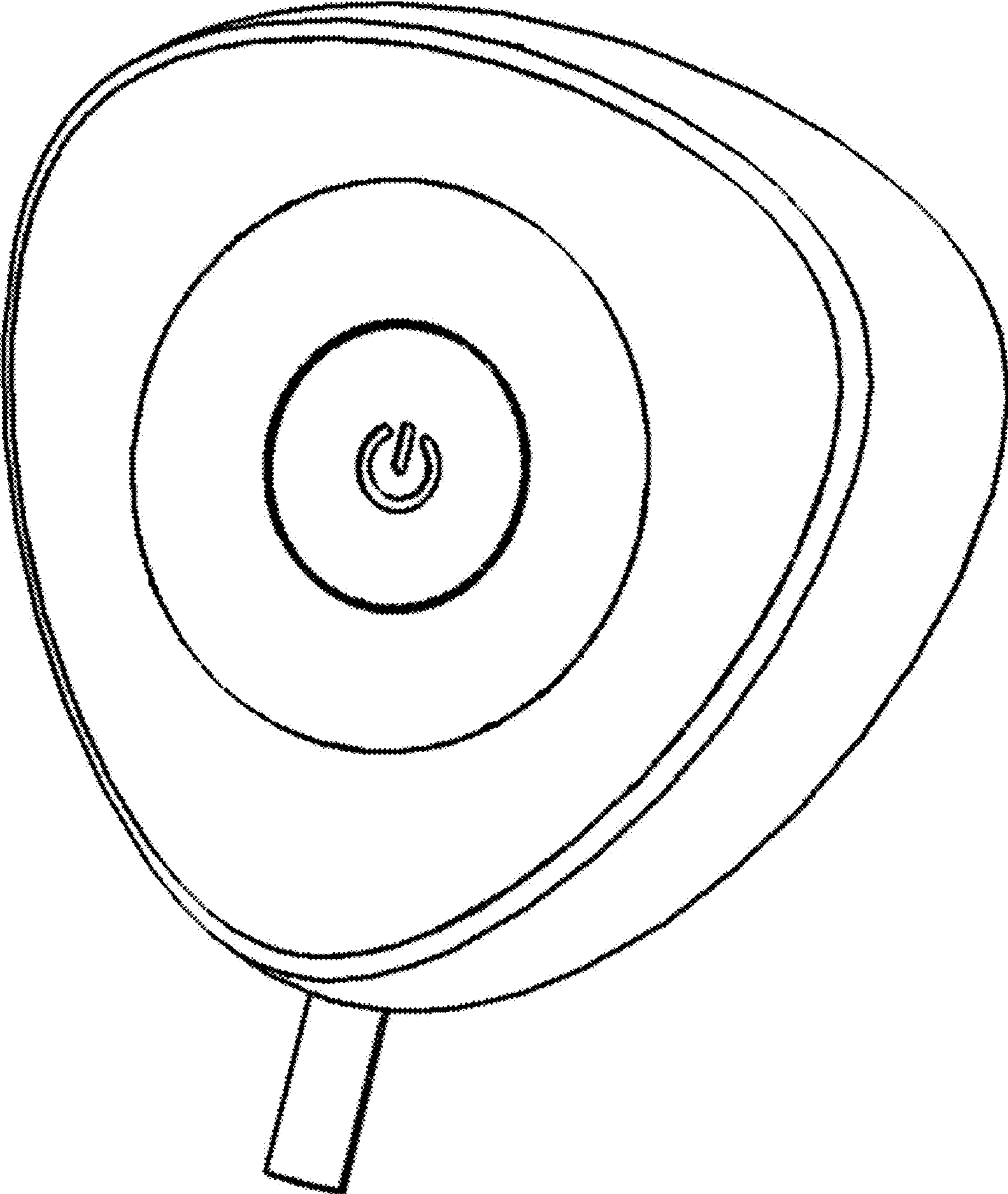

Fig. 1

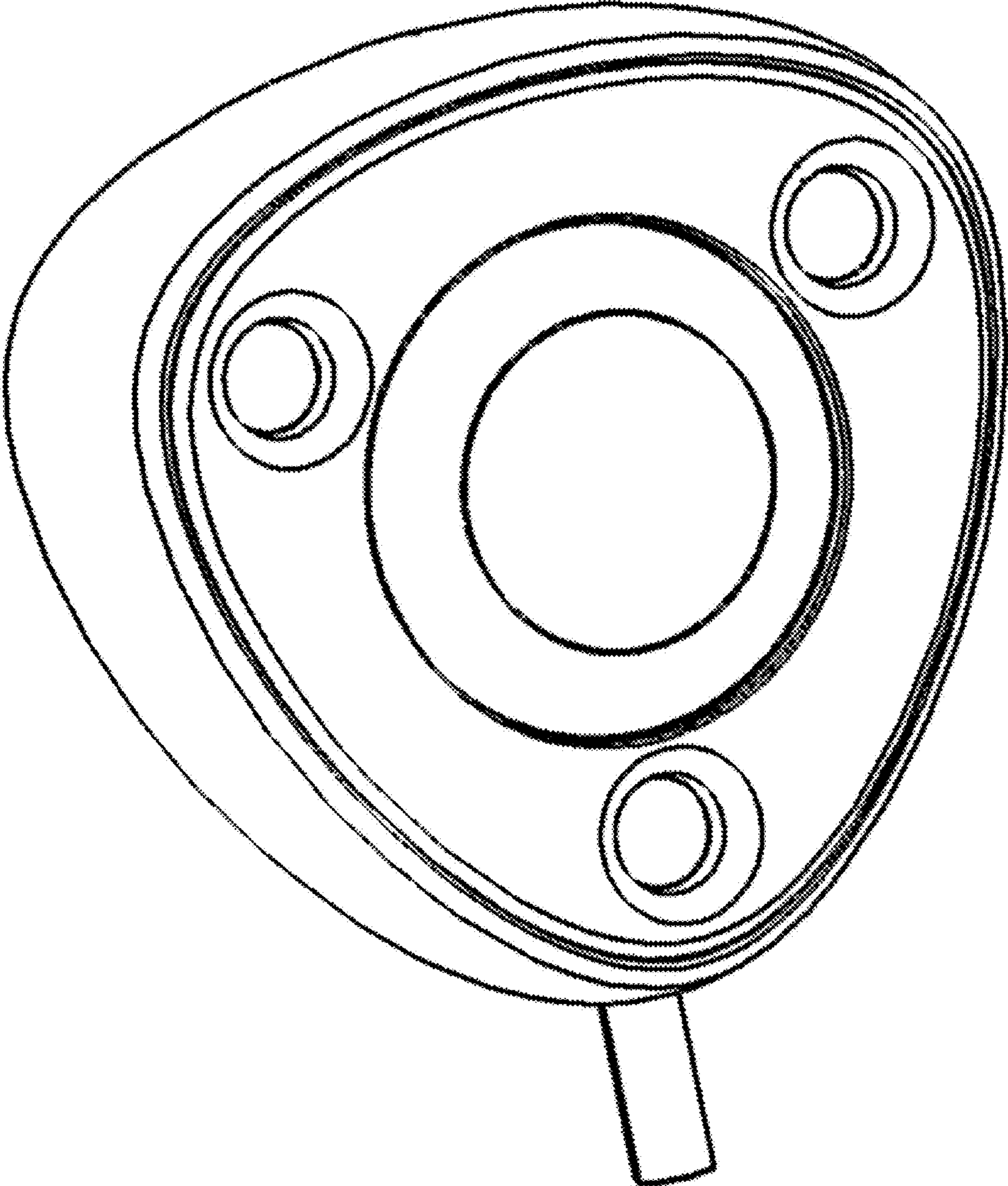

Fig. 2

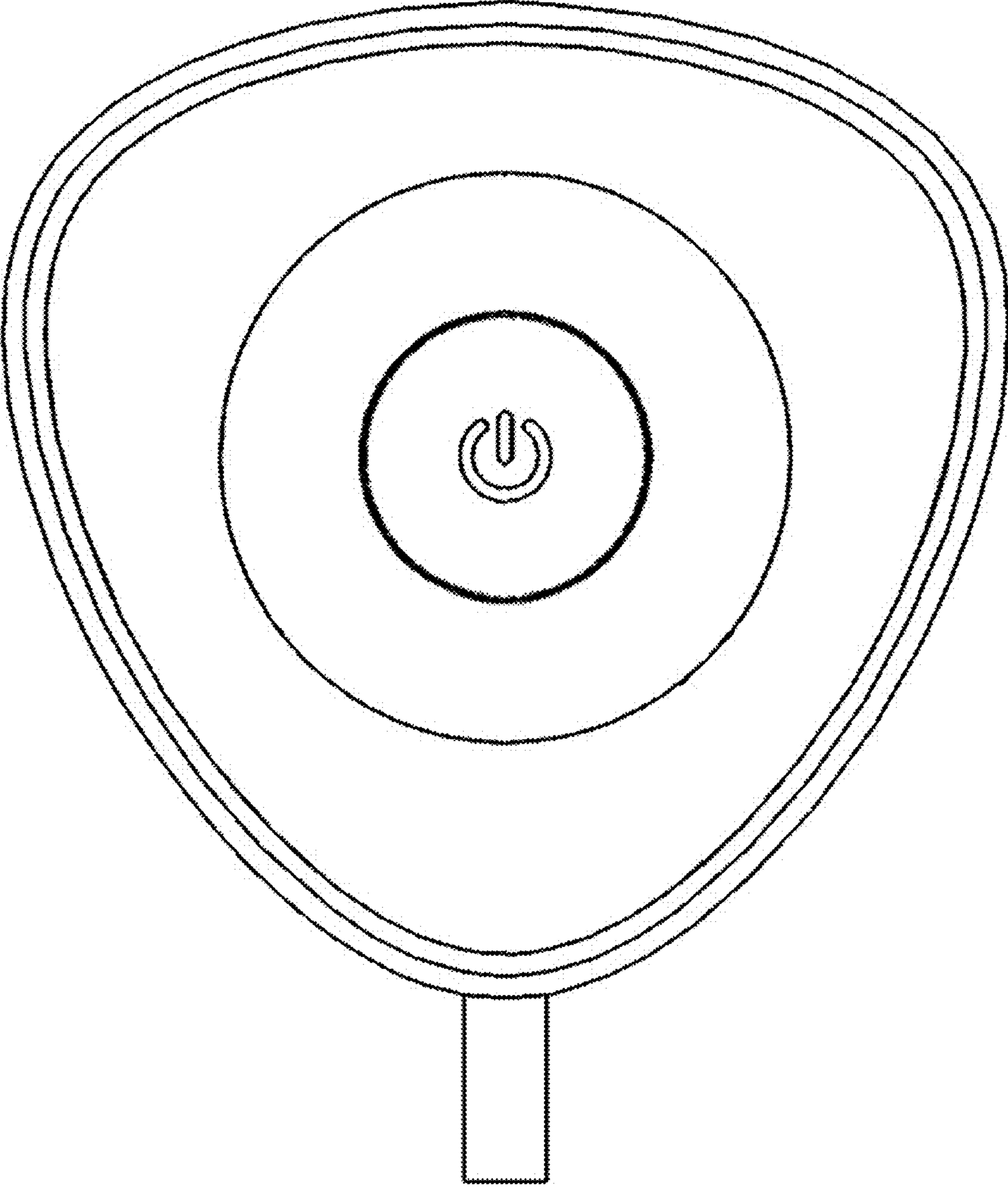

Fig. 3

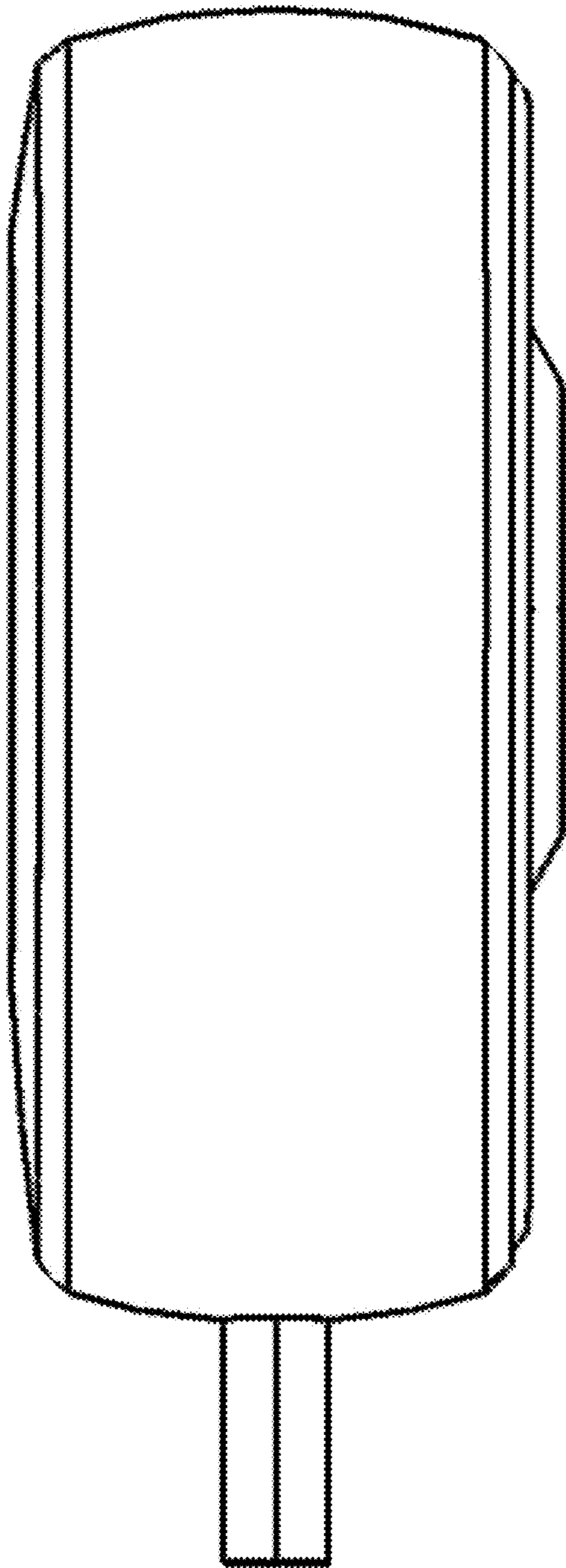

Fig. 4

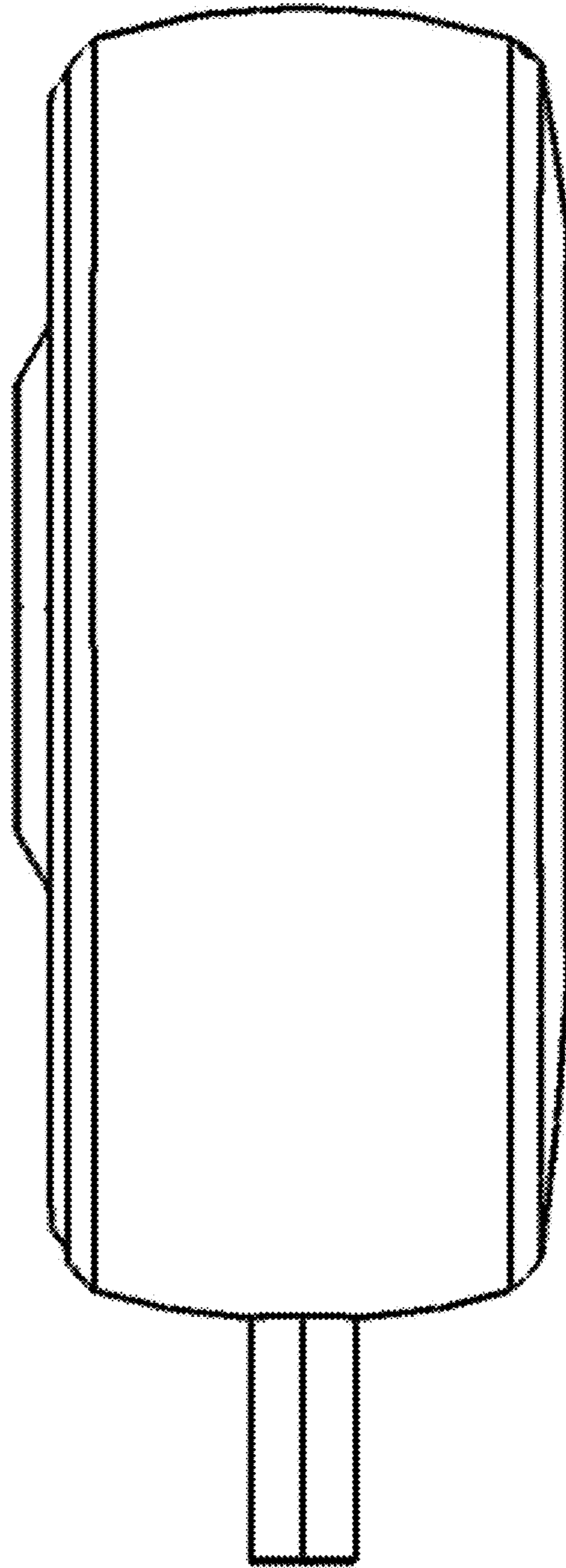

Fig. 5

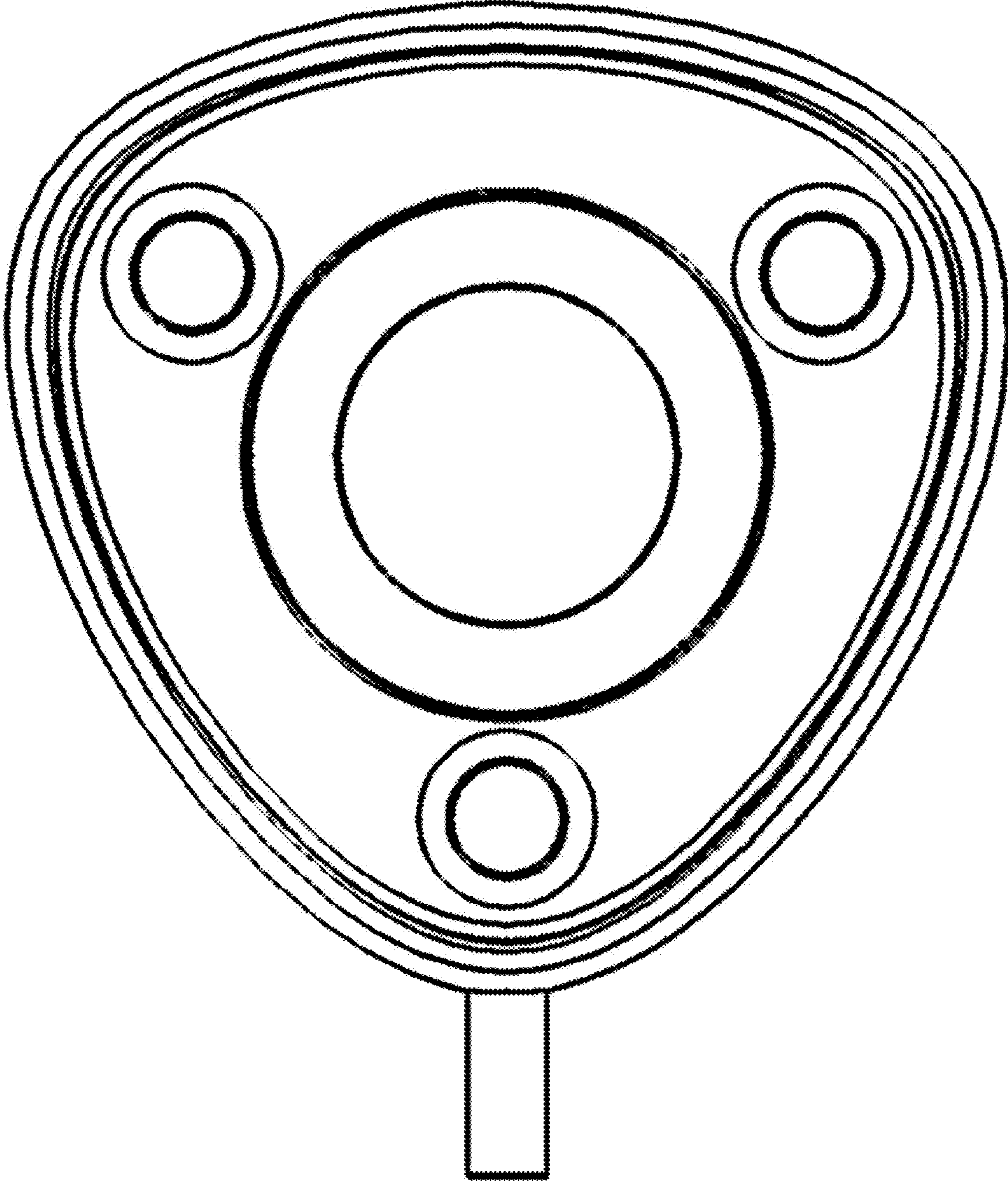

Fig. 6

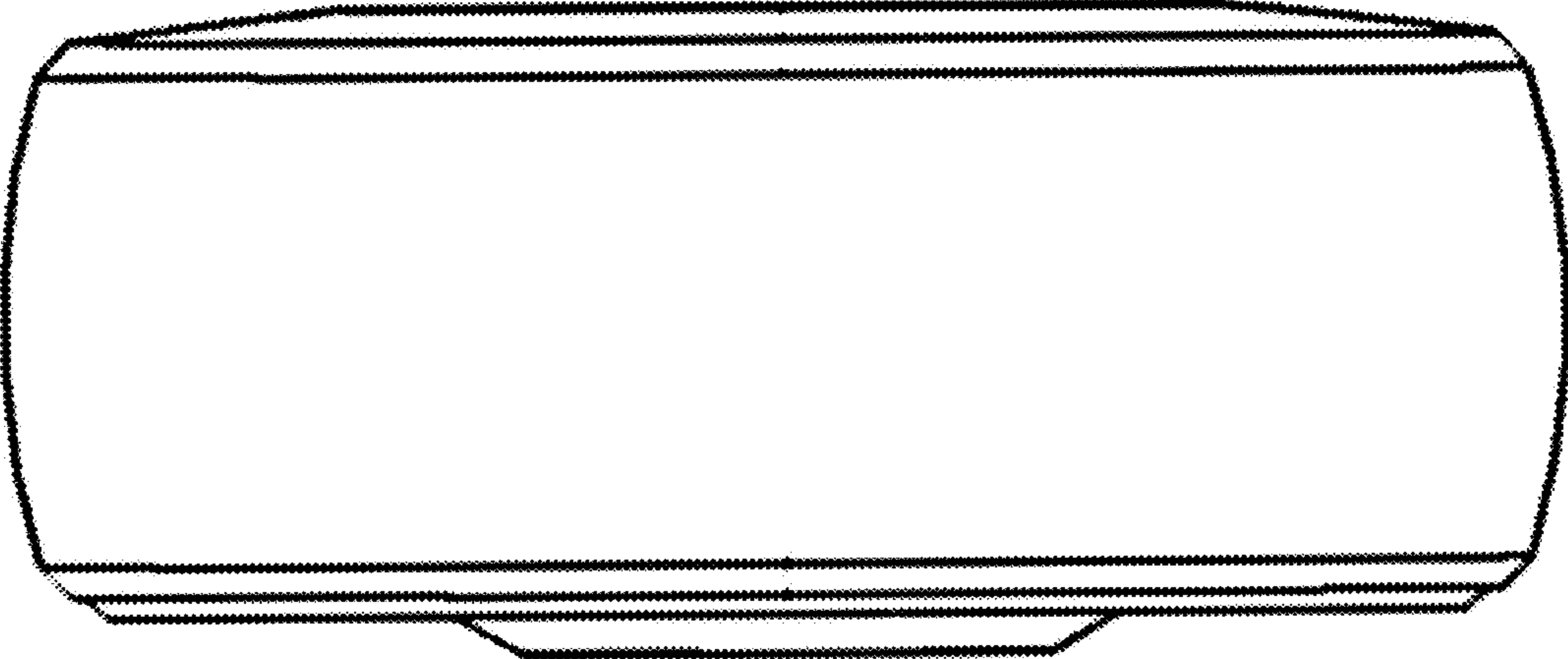

Fig. 7

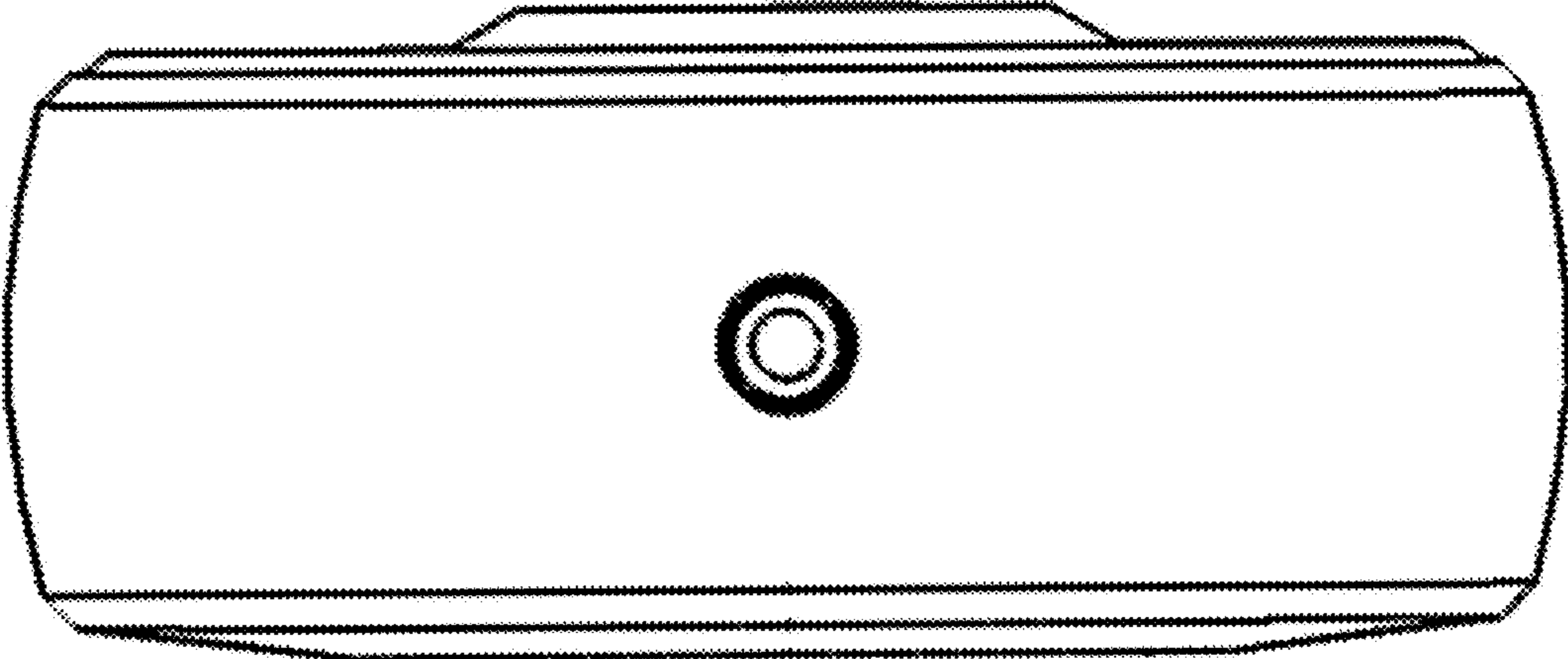

Fig. 8

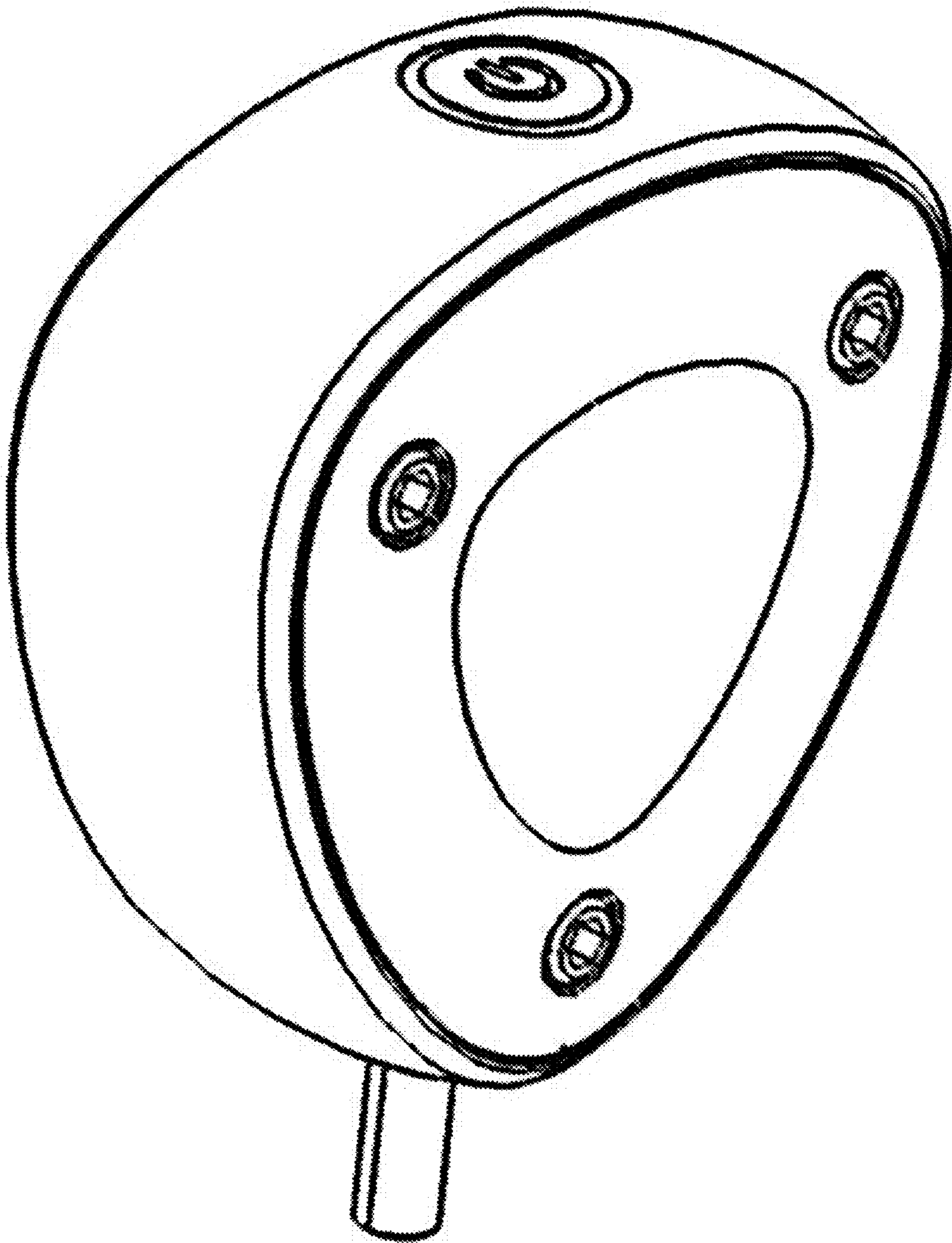

Fig. 9

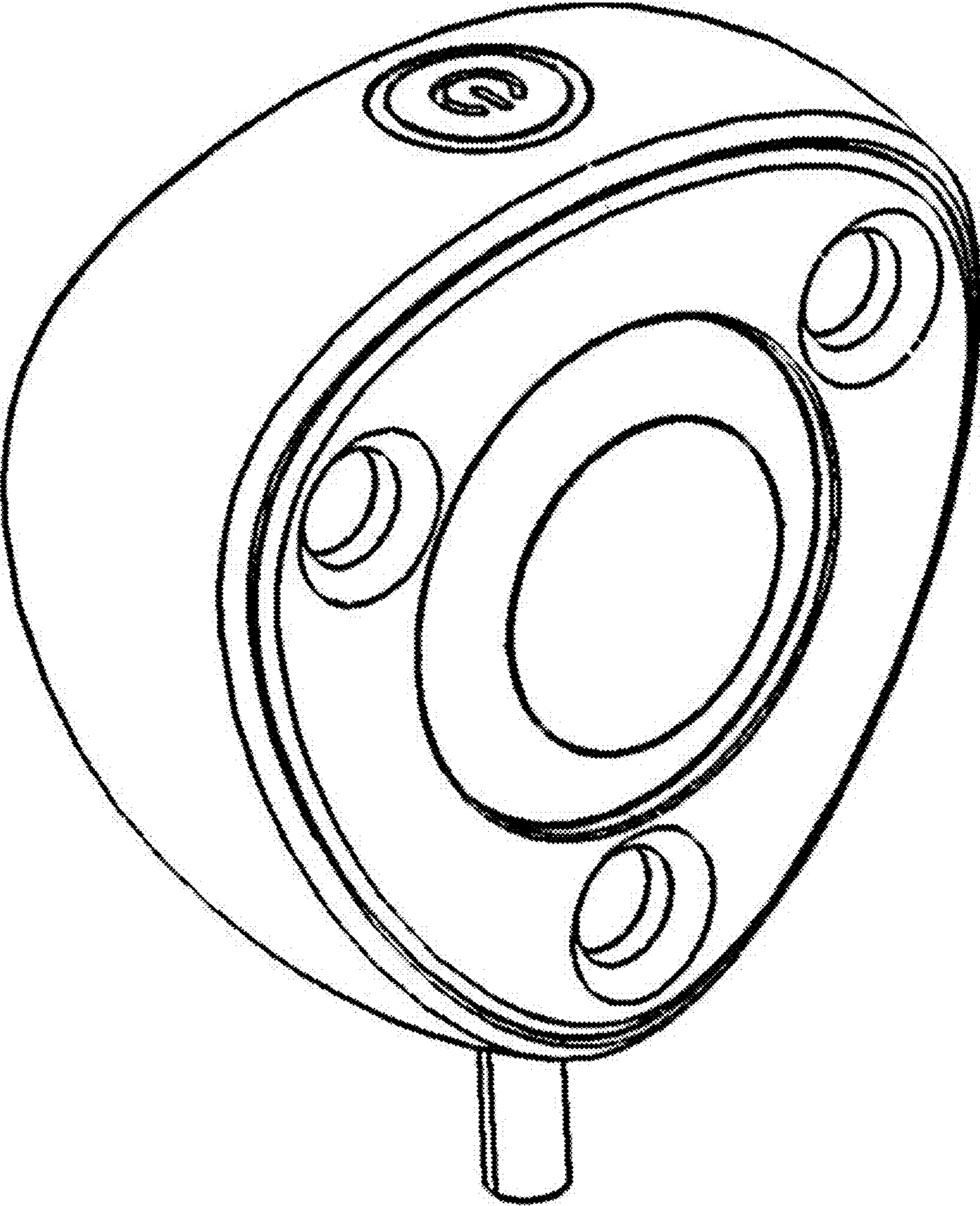

Fig. 10

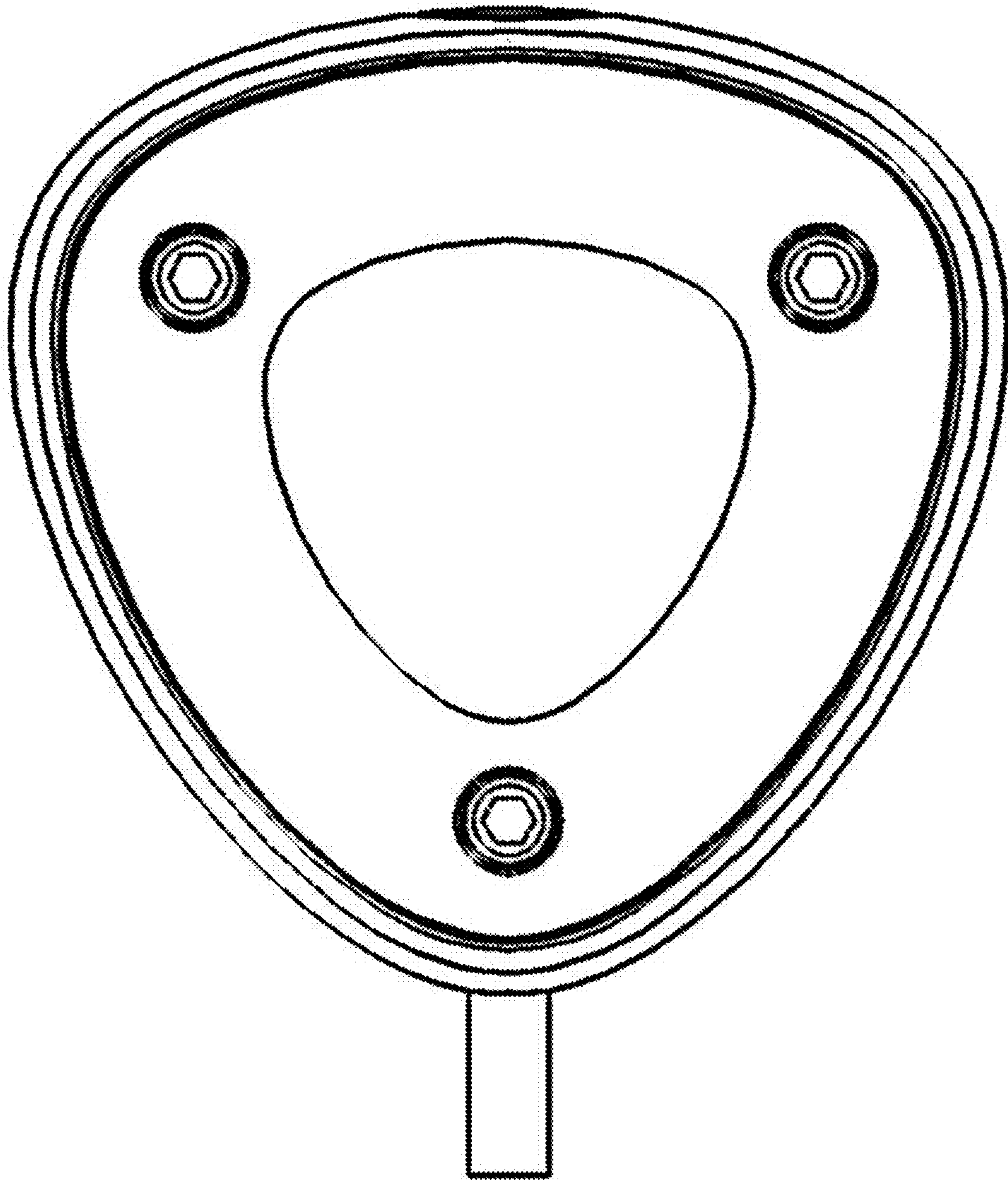

Fig. 11

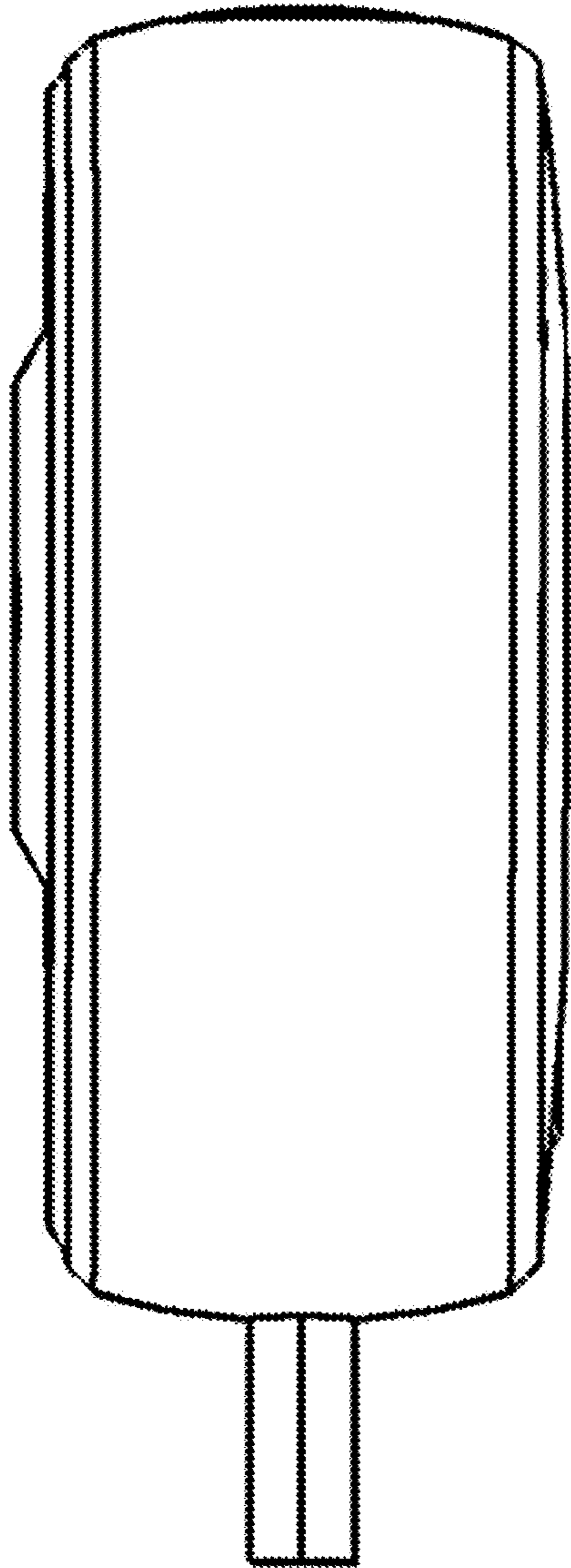

Fig. 12

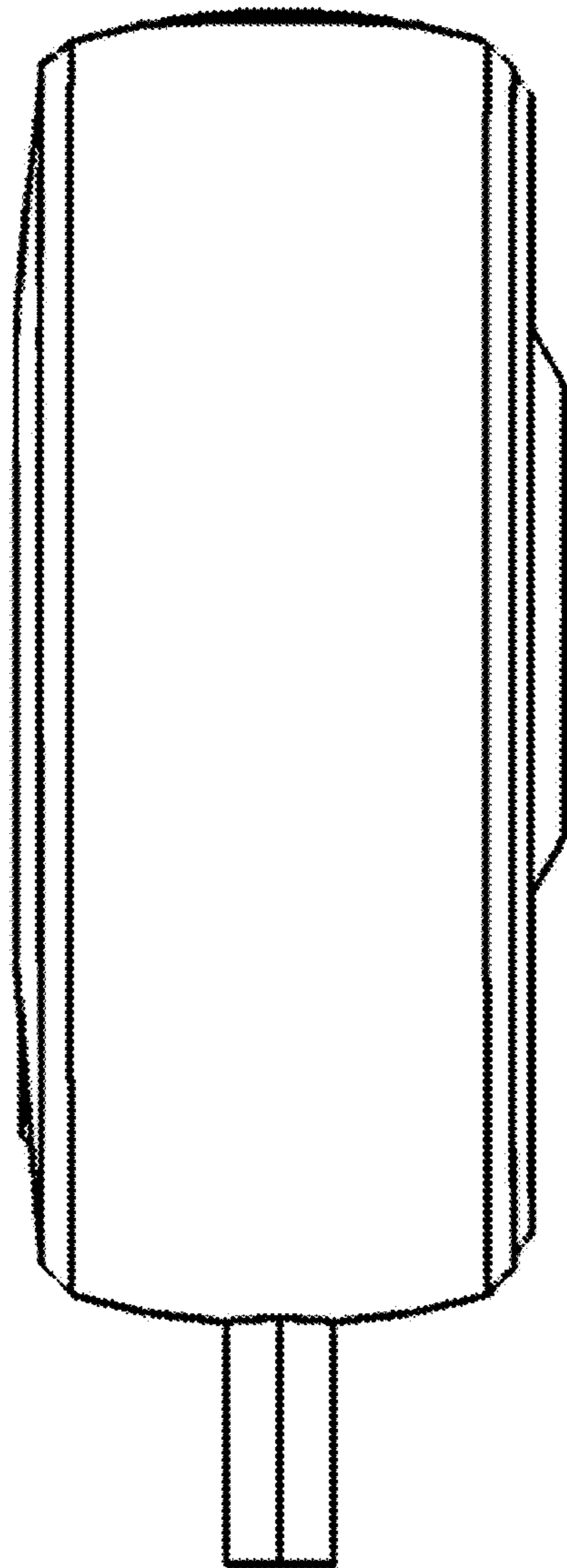

Fig. 13

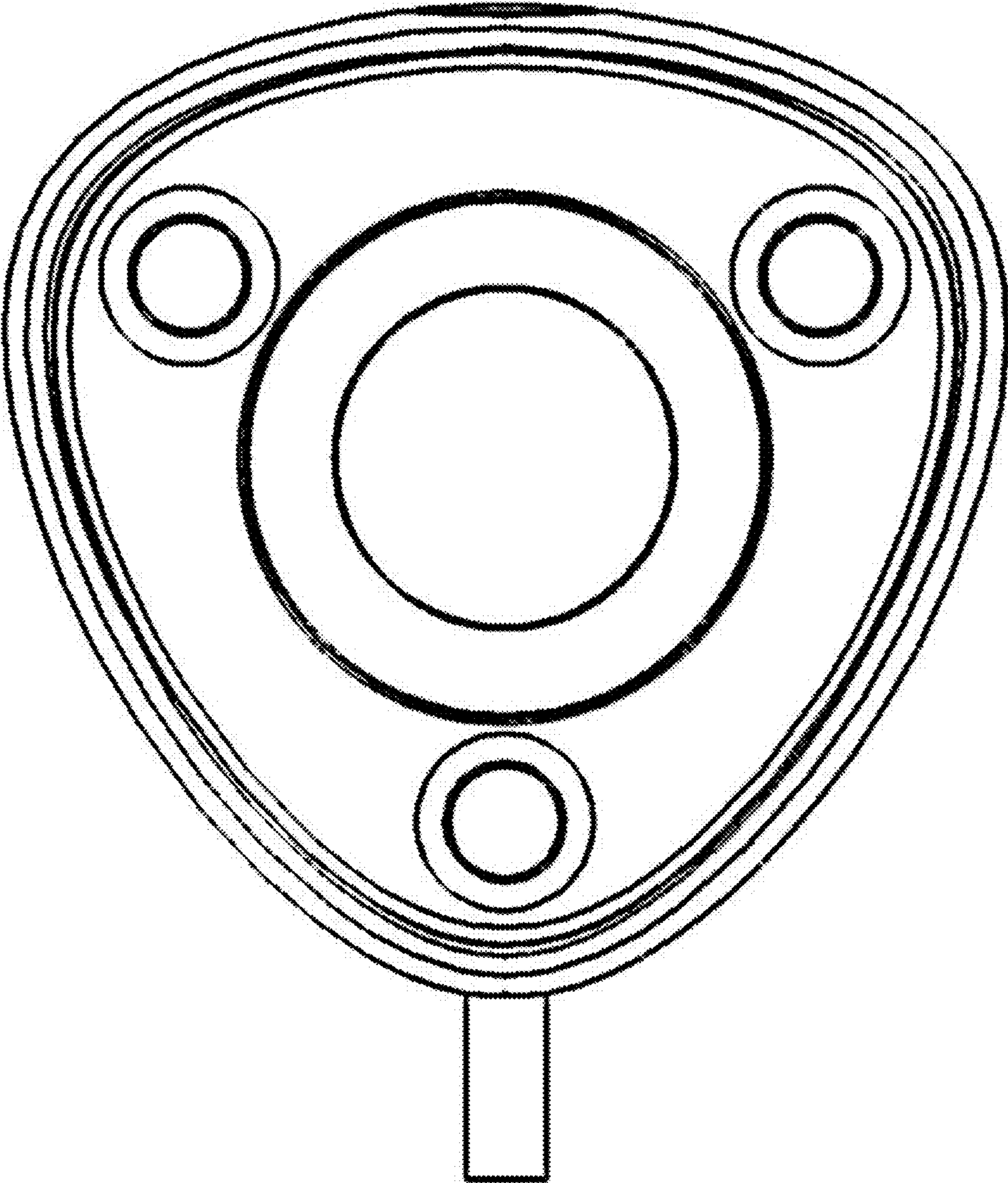

Fig. 14

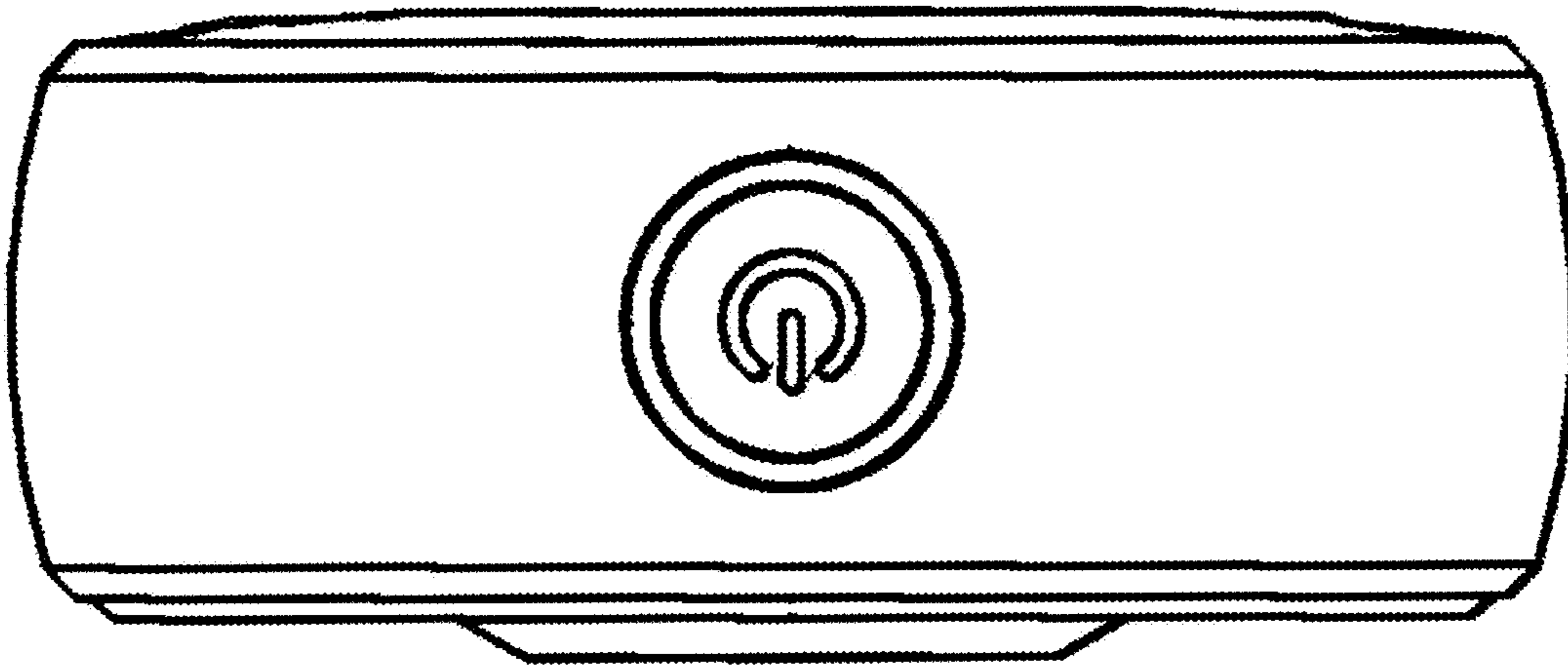

Fig. 15

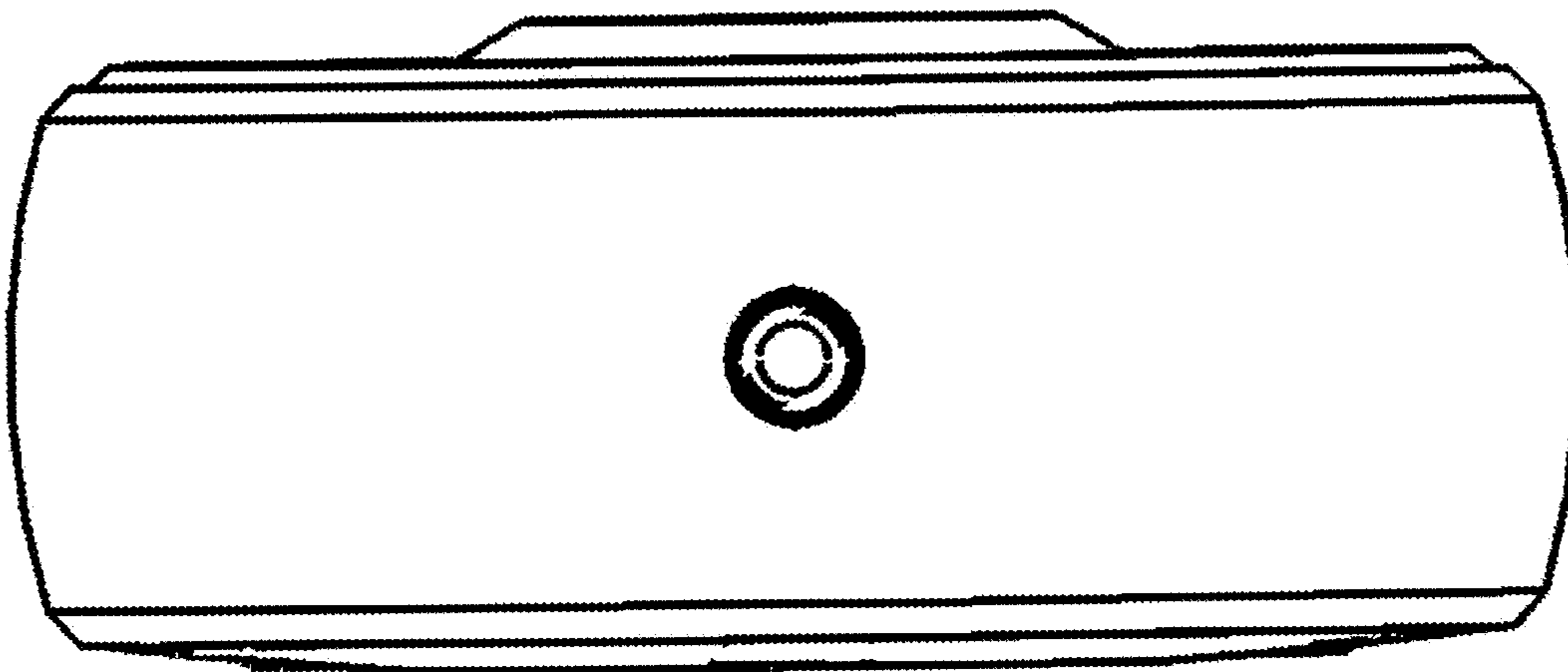

Fig. 16