



US00D615044S

(12) **United States Design Patent**  
**Nielsen et al.**

(10) **Patent No.:** **US D615,044 S**

(45) **Date of Patent:** **\*\* May 4, 2010**

(54) **MODULE WITH CONNECTORS**

(75) Inventors: **Carl Nielsen**, Lyngby (DK); **Lars Kroman**, Birkerød (DK); **Aage Vastrup**, Kokkedal (DK); **Helge Larsen**, Kokkedal (DK); **Carsten Hansen**, Lantau N.T. (HK); **Lars Thestrup**, Nærum (DK)

(73) Assignee: **Brüel & Kjaer Sound & Vibration Measurement A/S**, Naerum (DK)

(\*\*) Term: **14 Years**

(21) Appl. No.: **29/327,778**

(22) Filed: **Nov. 13, 2008**

(51) **LOC (9) Cl.** ..... **13-03**

(52) **U.S. Cl.** ..... **D13/147**

(58) **Field of Classification Search** ..... D13/133,  
D13/146-147, 154, 184; 348/728, 844; 391/729;  
439/535, 540.1, 578, 579, 580, 581, 582,  
439/583

See application file for complete search history.

(56) **References Cited**

**U.S. PATENT DOCUMENTS**

D220,569 S *	4/1971	De Carlo	.....	D13/147
D337,761 S *	7/1993	Morgan et al.	.....	D13/147
D458,905 S *	6/2002	Jahne et al.	.....	D13/158
D591,683 S *	5/2009	Suzuki et al.	.....	D13/147

\* cited by examiner

*Primary Examiner*—Daniel D Bui

(74) *Attorney, Agent, or Firm*—Stites & Harbison PLLC;  
Douglas E. Jackson

(57) **CLAIM**

The ornamental design for a module with connectors, as shown and described.

**DESCRIPTION**

FIG. 1 is a front, top and left side perspective view of a first embodiment of a module with connectors, showing our new design;

FIG. 2 is a back, top and right side view thereof.

FIG. 3 is a front view thereof.

FIG. 4 is a back view thereof.

FIG. 5 is a left side view thereof.

FIG. 6 is right side view thereof.

FIG. 7 is a top view thereof.

FIG. 8 is a bottom view thereof.

FIG. 9 is a left side view of a second embodiment of a module with connectors, showing our new design, the back, top and bottom views being the same as depicted in FIGS. 4, 7 and 8 thereof;

FIG. 10 is right side view thereof.

FIG. 11 is a front view thereof.

FIG. 12 is a left side view of a third embodiment of a module with connectors, showing our new design, the back, top and bottom views being the same as depicted in FIGS. 4, 7 and 8 thereof.

FIG. 13 is right side view thereof; and,

FIG. 14 is a front view thereof.

The different surface hatchings around or adjacent the front connectors of FIGS. 1 and 3 (three sets of hatchings), 11 (two sets of hatchings), and 14 (one set of hatchings) are provided to show contrasting colors at these surfaces.

**1 Claim, 11 Drawing Sheets**

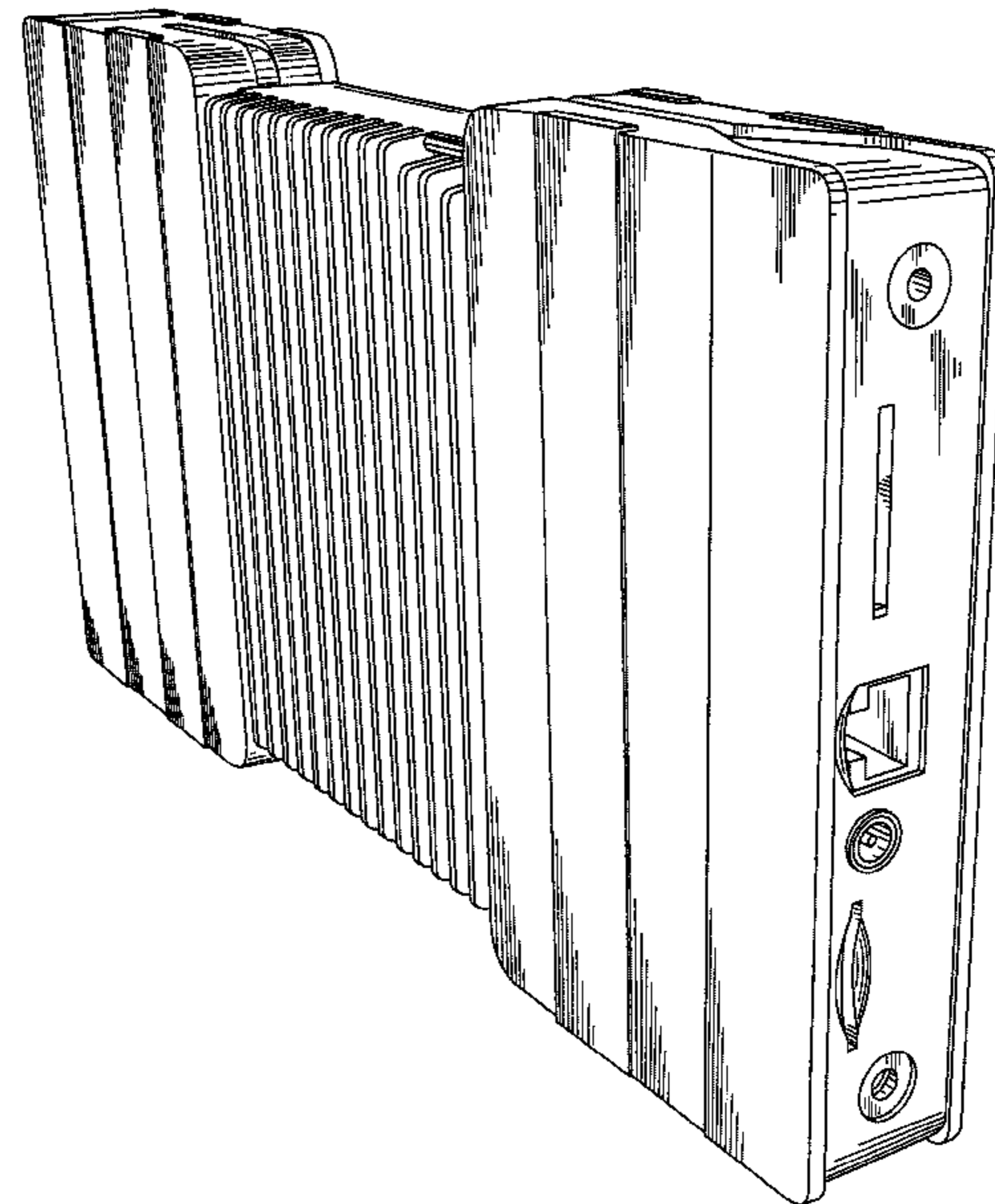
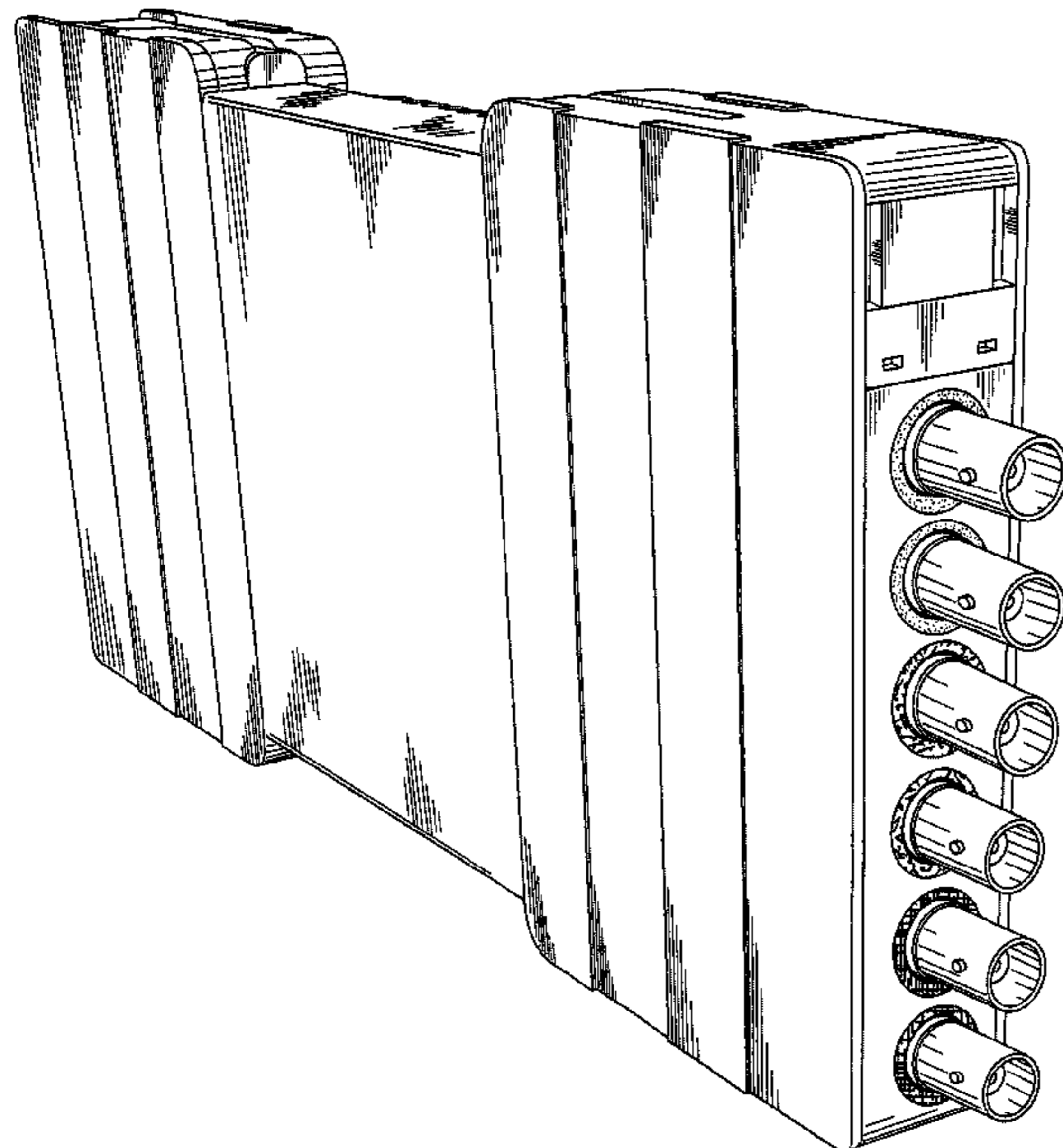

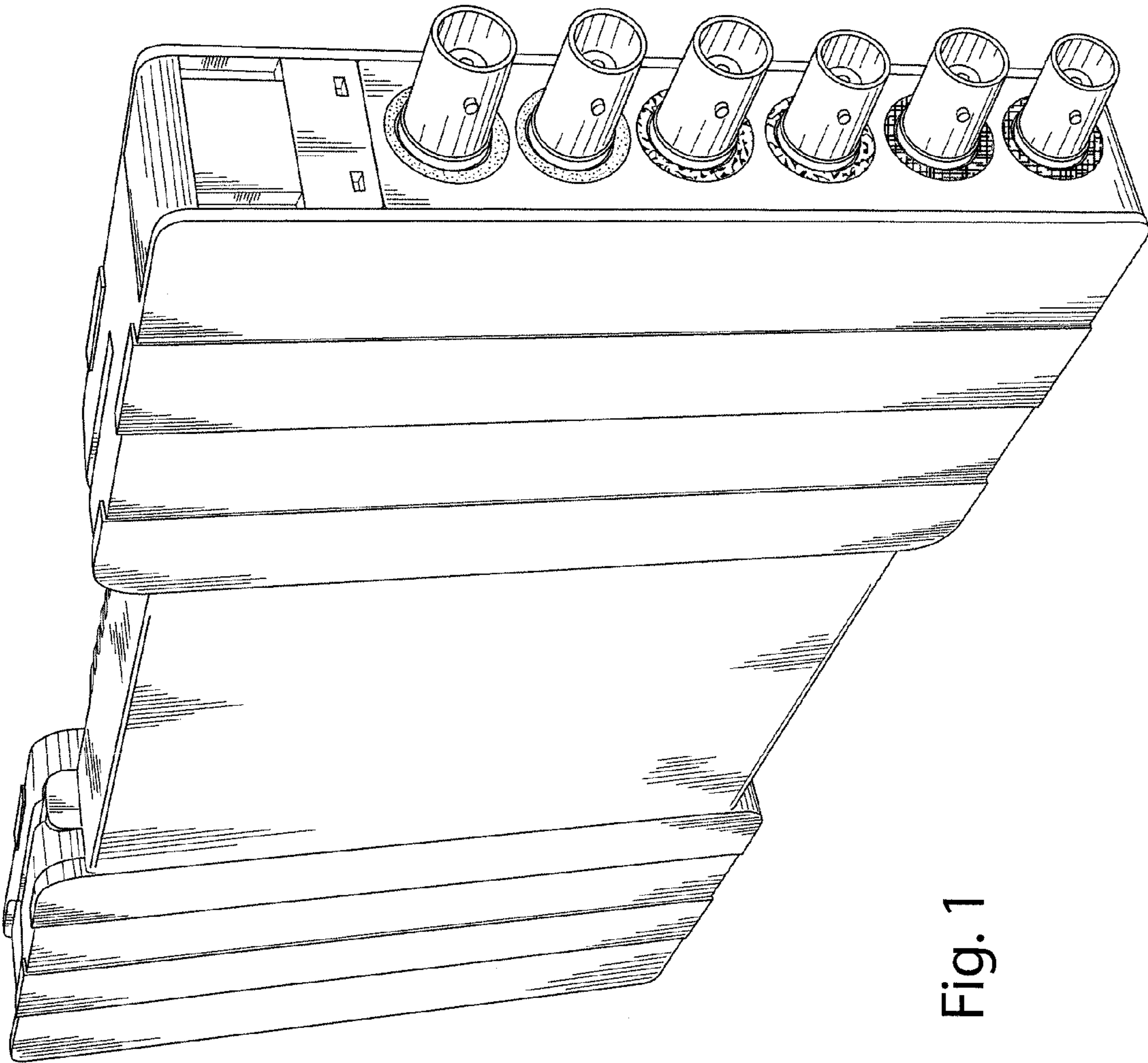

Fig. 1

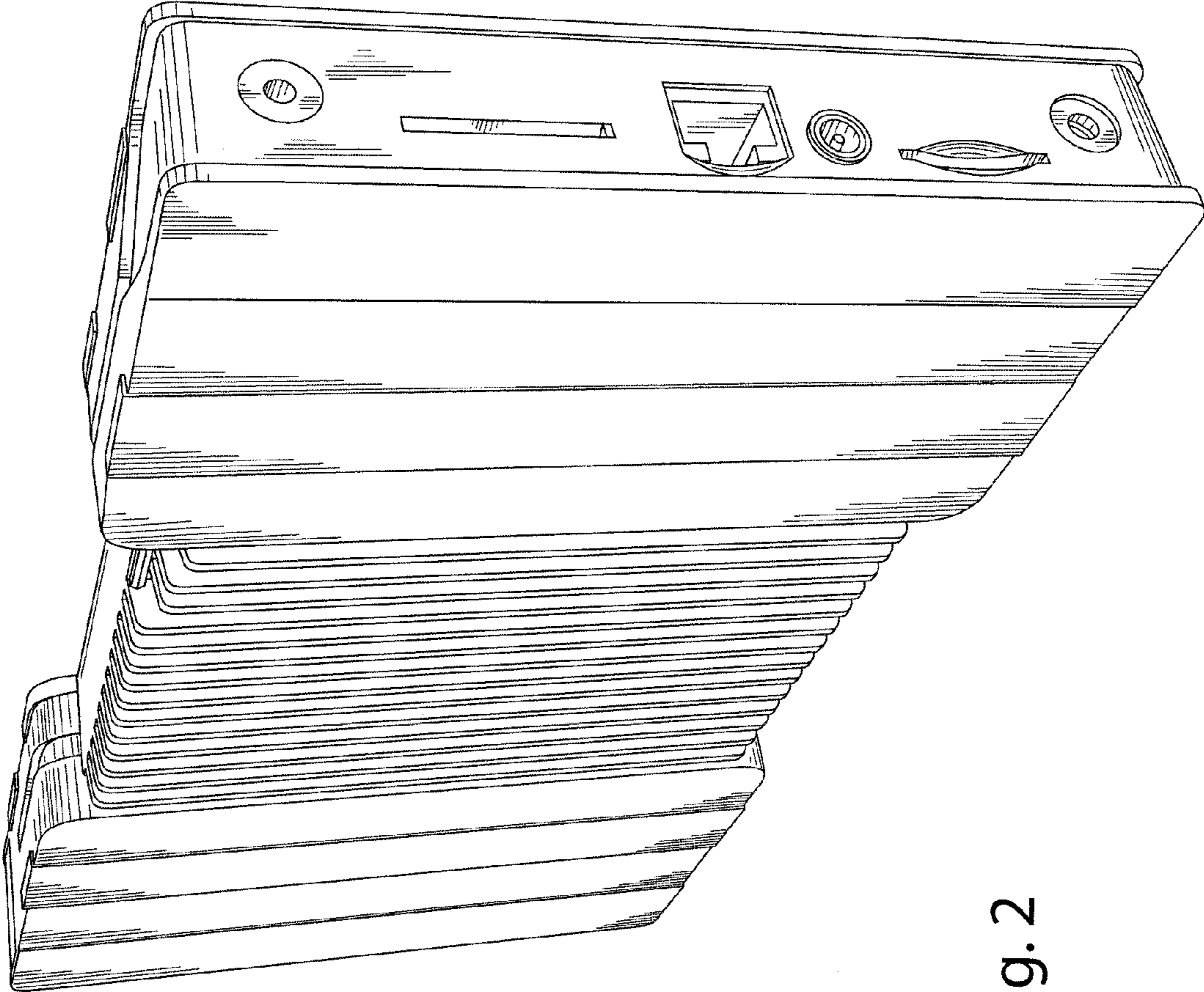

Fig. 2



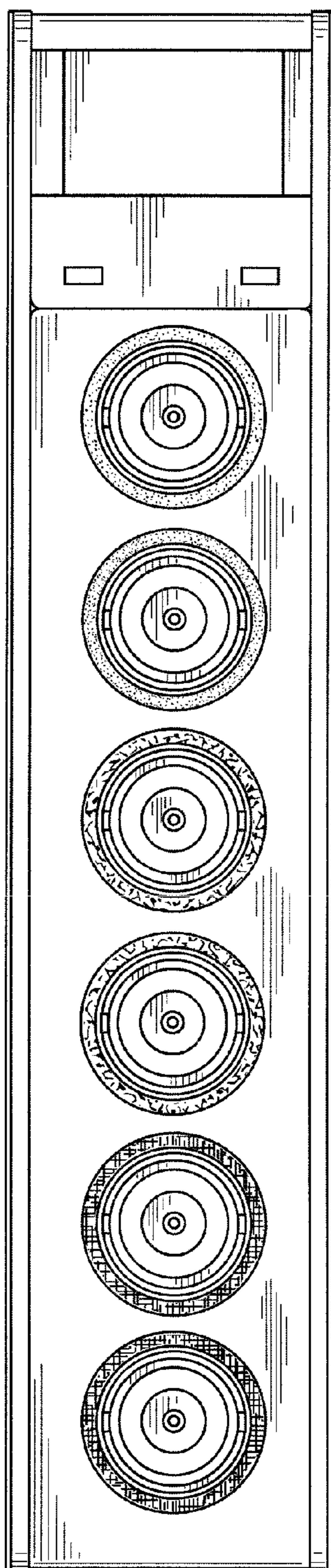

Fig. 3

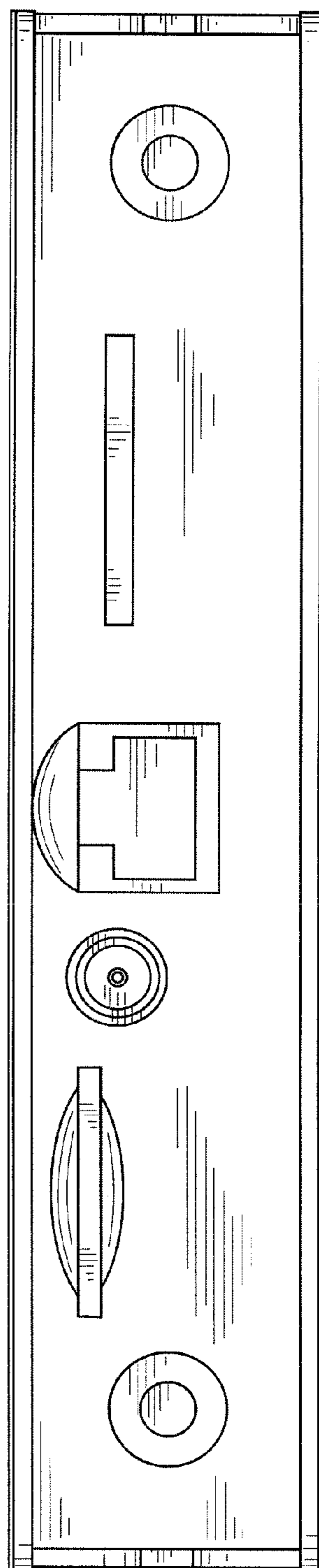

Fig. 4

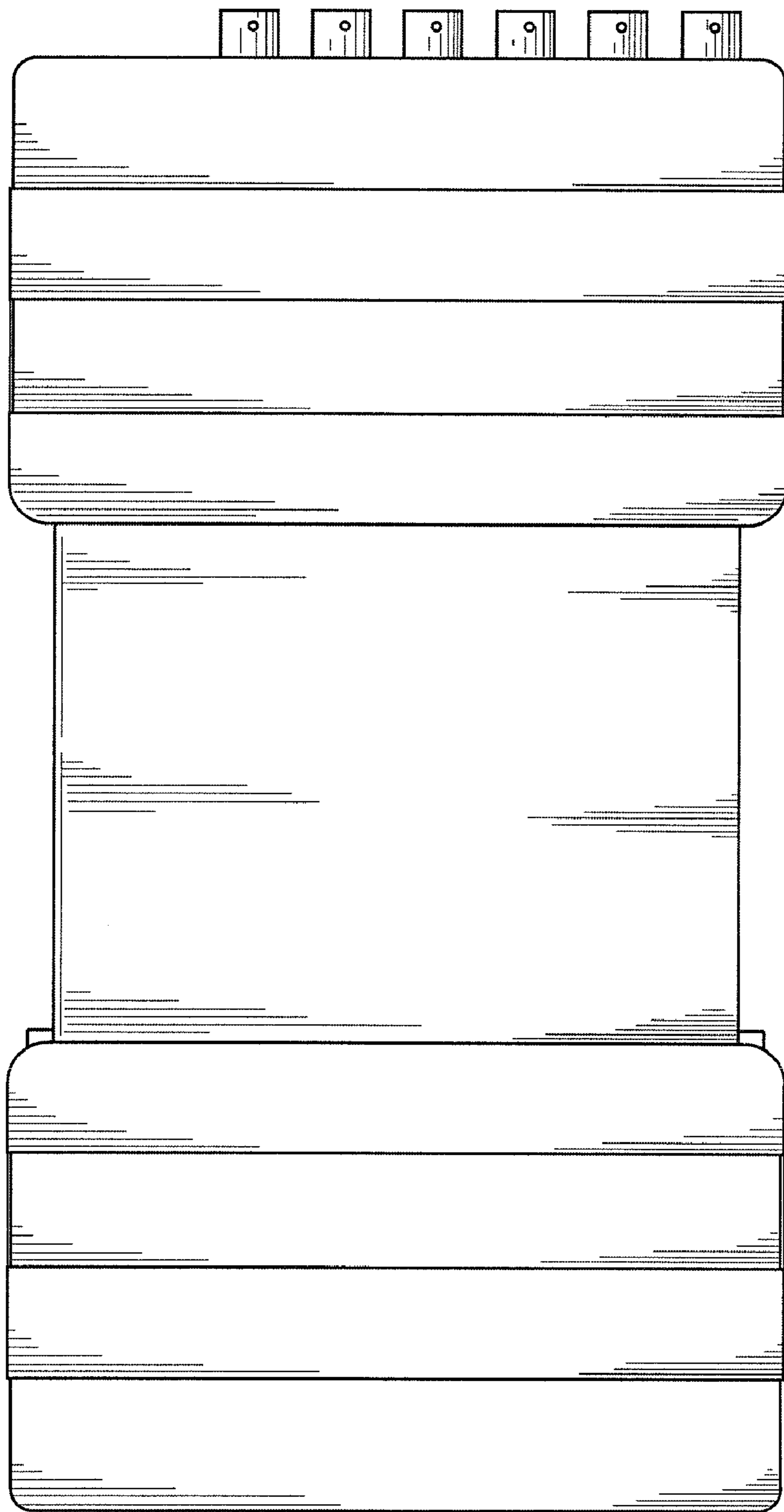

Fig. 5

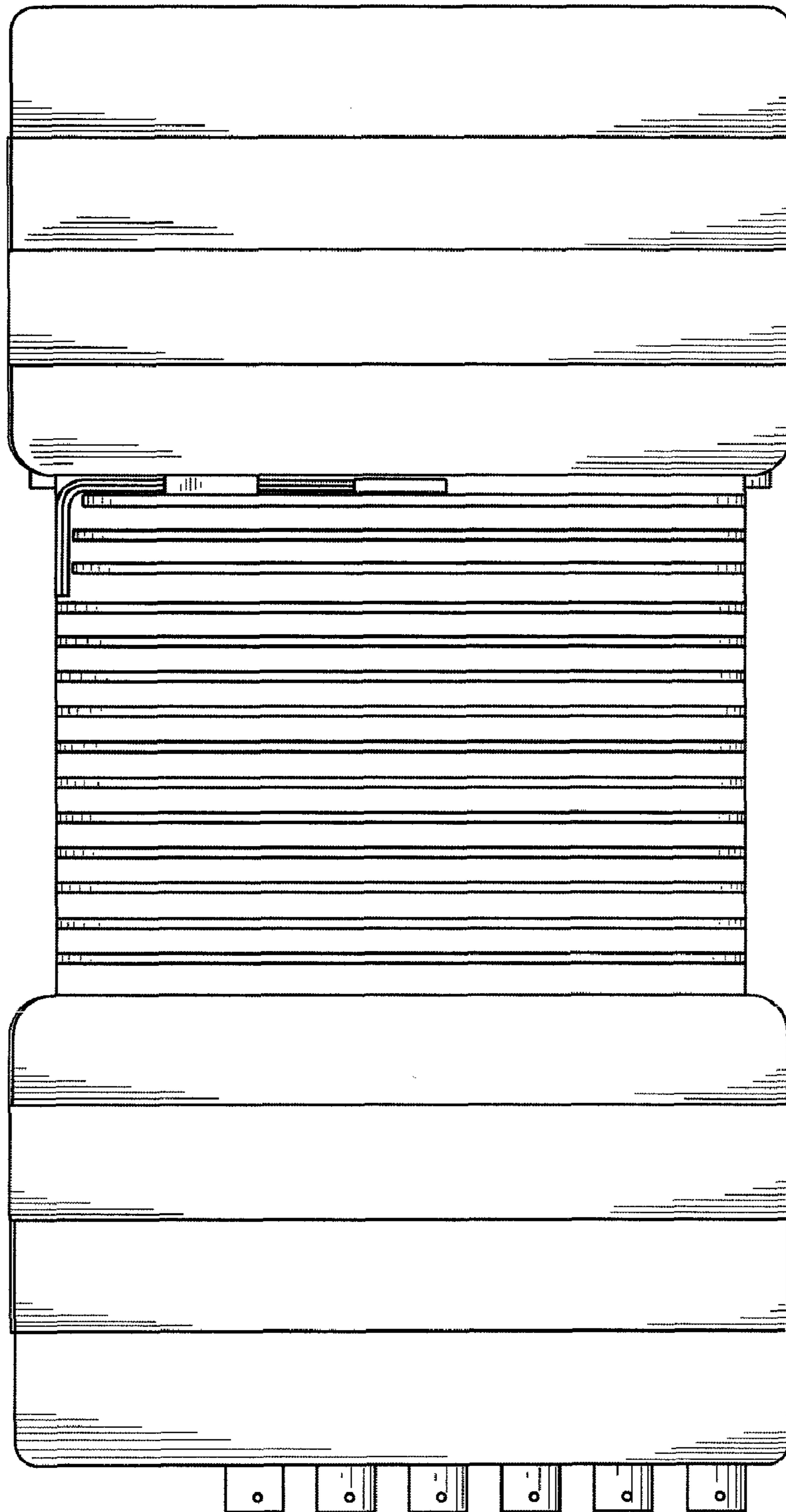

Fig. 6

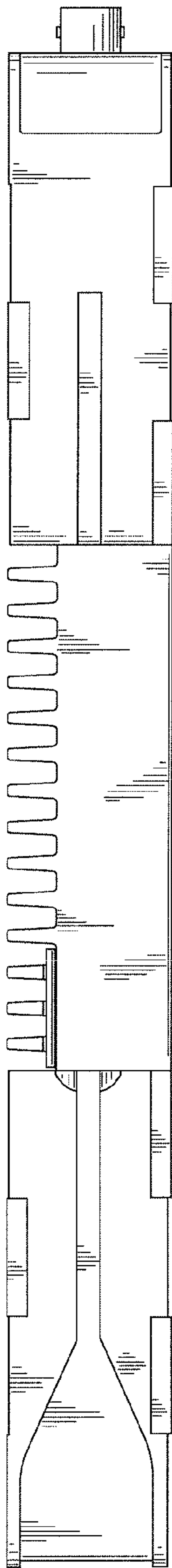

Fig. 7

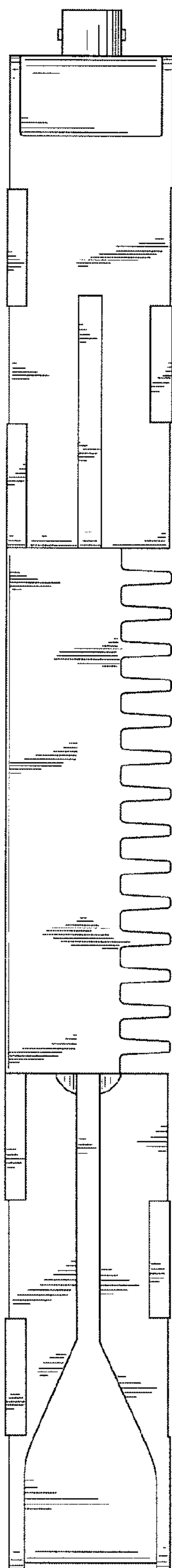

Fig. 8

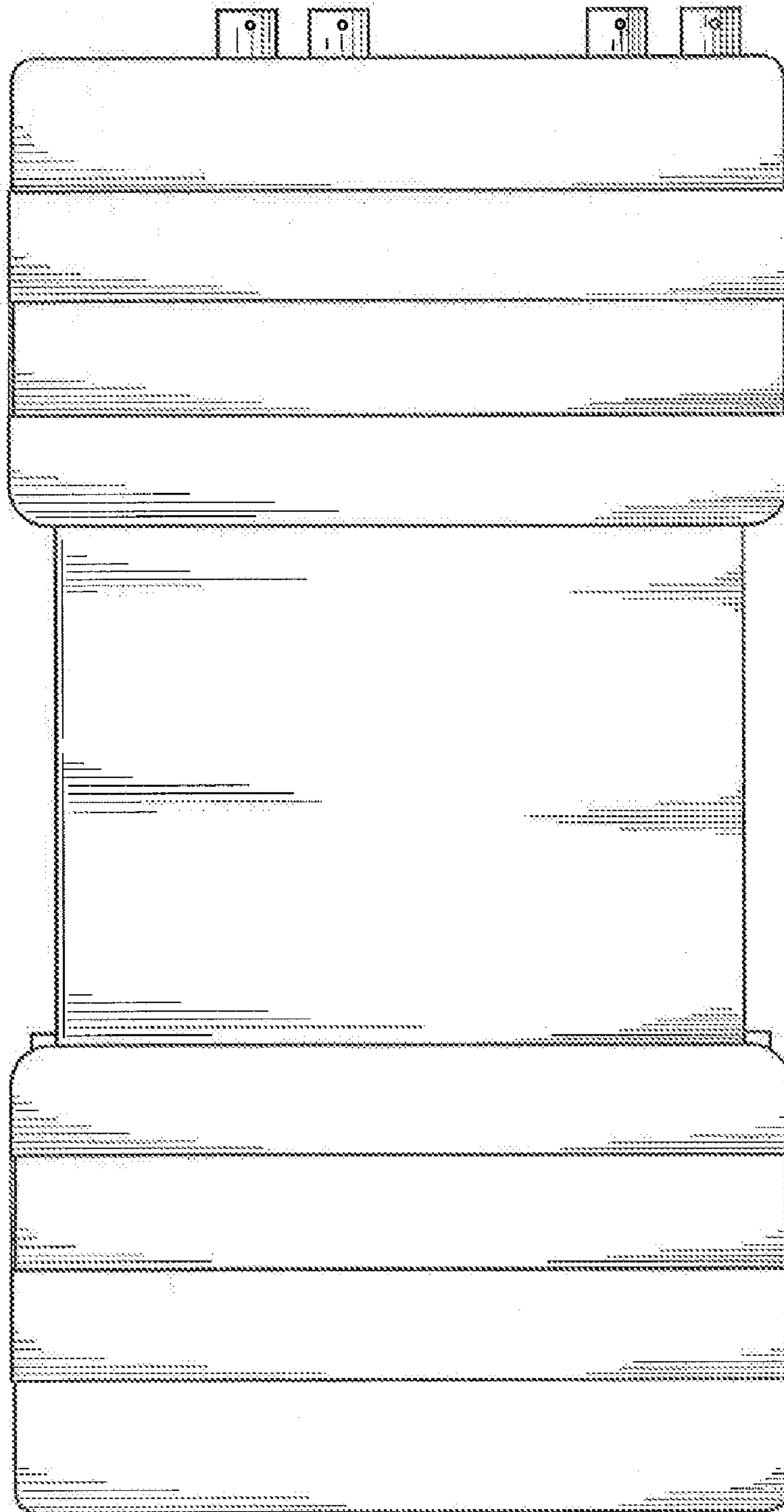

Fig. 9



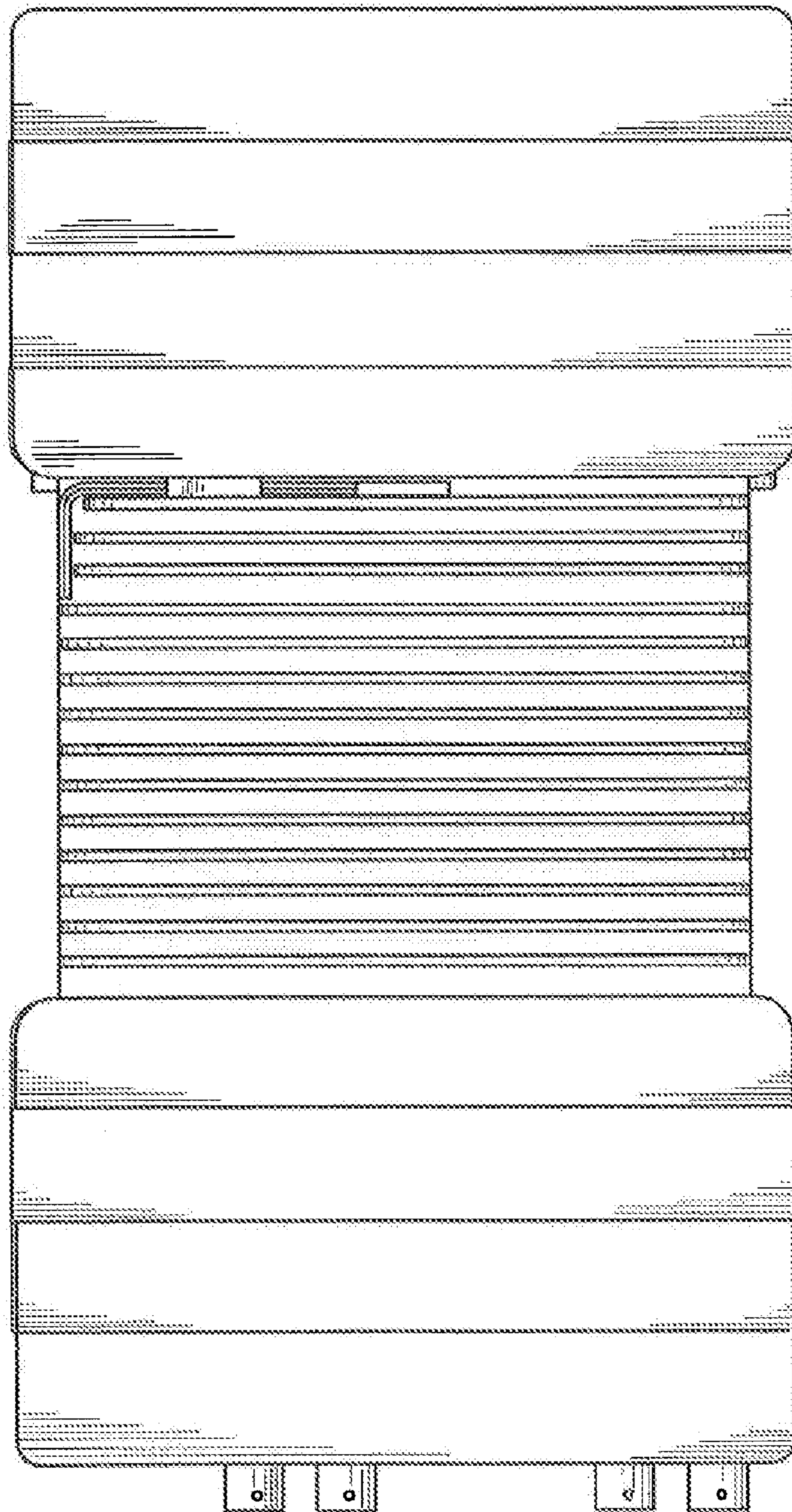

Fig. 10

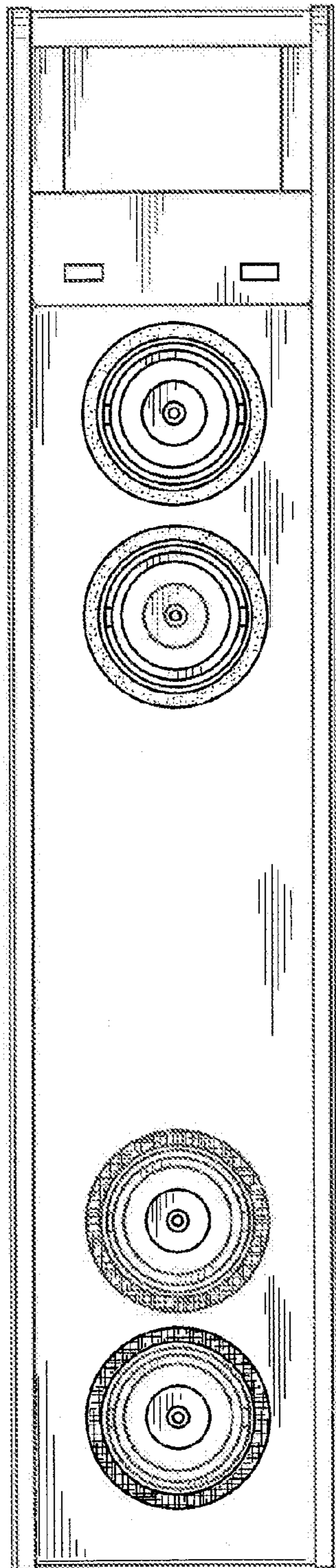

Fig. 11

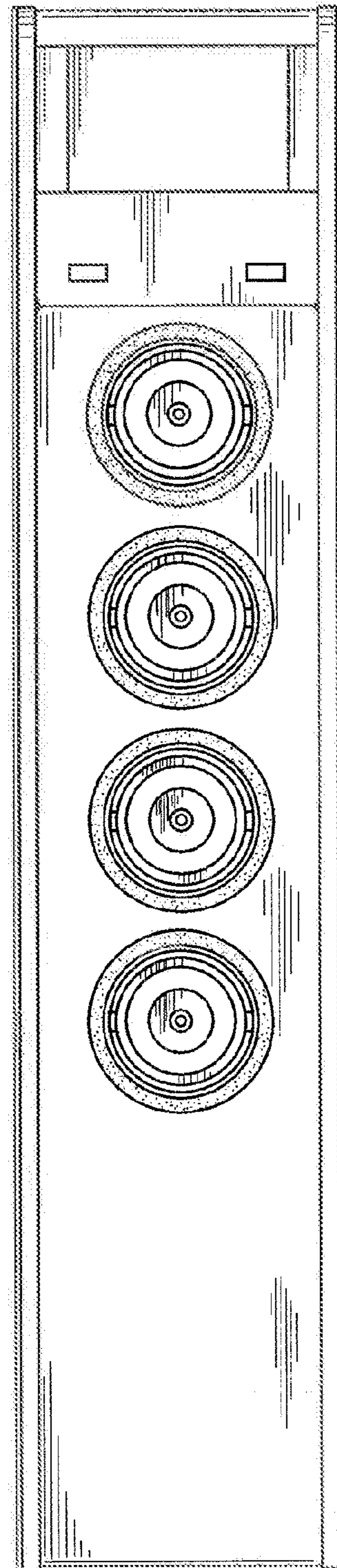

Fig. 14

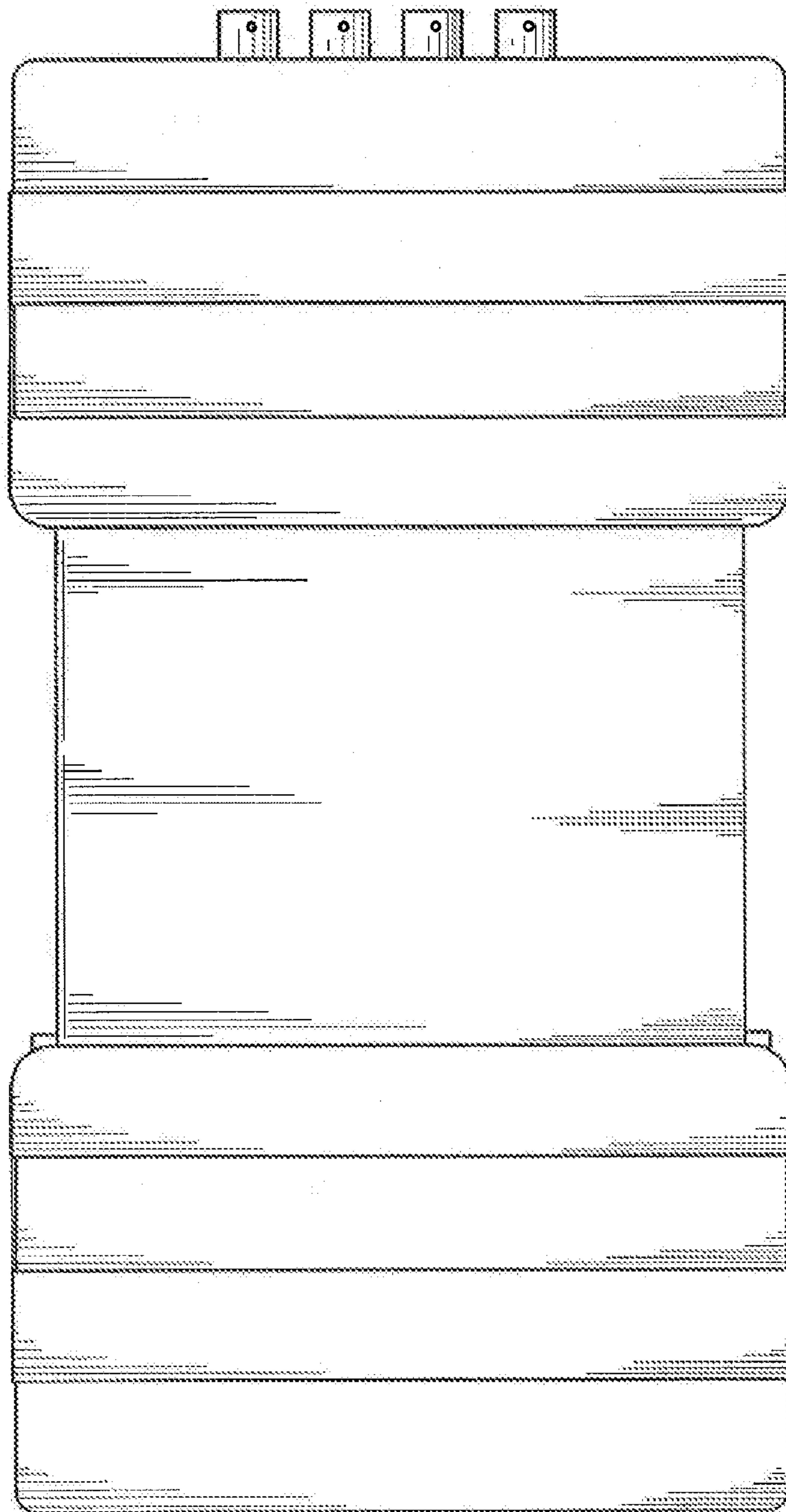

Fig. 12



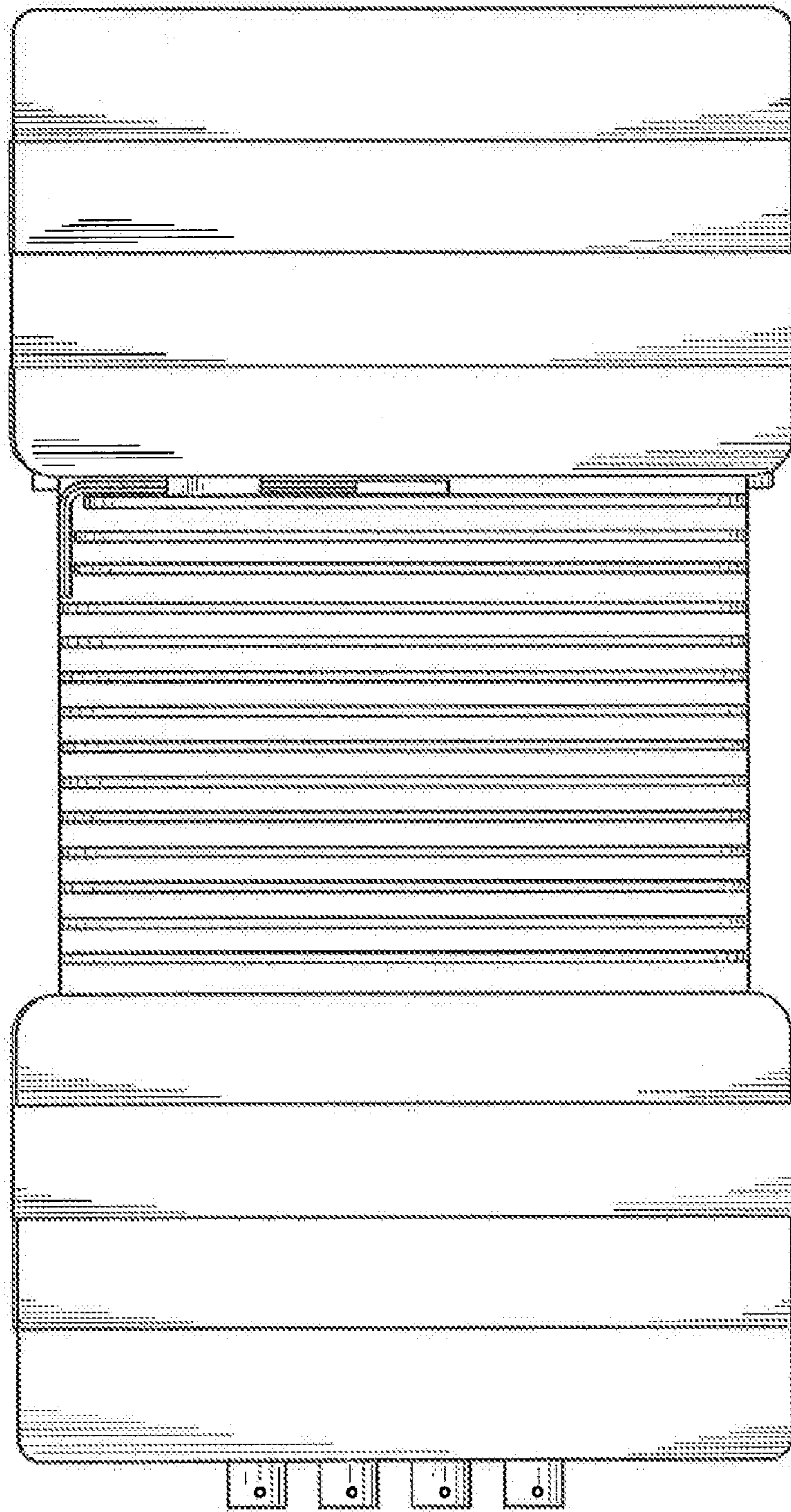

Fig. 13