



US00D614936S

(12) **United States Design Patent**
Petzl

(10) **Patent No.:** **US D614,936 S**
(45) **Date of Patent:** **** May 4, 2010**

(54) **HANDLE FOR CLIMBING APPARATUS**

2007/0215411 A1 * 9/2007 Petzl et al. 182/193
2008/0104809 A1 * 5/2008 Lin 24/600.1
2009/0008188 A1 * 1/2009 Bronnaz et al. 182/133

(75) Inventor: **Paul Petzl**, Barrauz (FR)

(73) Assignee: **Zedel**, Crolles (FR)

(**) Term: **14 Years**

(21) Appl. No.: **29/329,111**

(22) Filed: **Dec. 9, 2008**

(30) **Foreign Application Priority Data**

Jun. 19, 2008 (EM) 000 958681-0001

(51) **LOC (9) Cl.** **08-05**

(52) **U.S. Cl.** **D8/356**

(58) **Field of Classification Search** D8/105,
D8/107, 333, 349, 356, 358, 357, 373, 383;
D11/200, 215; 24/573.11, 579.09, 579.11,
24/592.11, 599.1, 599.9, 600.1; 182/5

See application file for complete search history.

(56) **References Cited**

U.S. PATENT DOCUMENTS

3,920,265 A * 11/1975 Nilsson 297/483
4,206,940 A * 6/1980 Altabe 294/82.19
4,402,529 A * 9/1983 Cavazza 280/816
5,400,869 A * 3/1995 Rocourt 182/133
5,463,798 A * 11/1995 Wurzer 24/599.5
D397,018 S * 8/1998 Mosley D8/107
5,934,408 A * 8/1999 Flux 182/5
6,029,777 A * 2/2000 Rogelja 182/193
6,283,523 B1 * 9/2001 Simond 294/82.2
6,283,524 B1 * 9/2001 Simond 294/82.2
6,488,267 B1 * 12/2002 Goldberg et al. 254/264
6,681,891 B2 * 1/2004 Richard et al. 182/5
6,793,046 B2 * 9/2004 Petzl et al. 188/188
6,810,818 B2 * 11/2004 Petzl et al. 105/150
6,843,346 B2 * 1/2005 LeBeau et al. 182/5
7,080,716 B2 * 7/2006 Cherpitel 182/192
7,137,481 B2 * 11/2006 Petzl et al. 182/192
7,225,544 B2 * 6/2007 Petzl 30/381
D556,533 S * 12/2007 Gobbi D8/80
D562,383 S * 2/2008 Stokes D19/36

FOREIGN PATENT DOCUMENTS

EP 18302 A1 * 10/1980
EP 536057 A1 * 4/1993
EP 1533006 A1 * 5/2005

(Continued)

OTHER PUBLICATIONS

Petzl Ascension Ascender Right Hand Jumar Rock Climbing, item listed on ebay, 5 pages, <http://cgi.ebay.com/ws/eBayISAPI.dll?ViewItem&item=110419303840&ih=001&category=50814&ssPageName=WDVW&rd=1> Internet search of carabiners on Aug. 1, 2009.*

(Continued)

Primary Examiner—Robert M Spear
Assistant Examiner—Karen Acker
(74) *Attorney, Agent, or Firm*—Oliff & Berridge, PLC

(57) **CLAIM**

The ornamental design for a handle for climbing apparatus, as shown and described.

DESCRIPTION

FIG. 1 is a front view of a handle for climbing apparatus;
FIG. 2 is rear view thereof;
FIG. 3 is a right-side view thereof;
FIG. 4 is a left-side view thereof;
FIG. 5 is a top view thereof; and,
FIG. 6 is a bottom view thereof.

The broken lines depict environmental subject matter only and form no part of the claimed design.

1 Claim, 4 Drawing Sheets

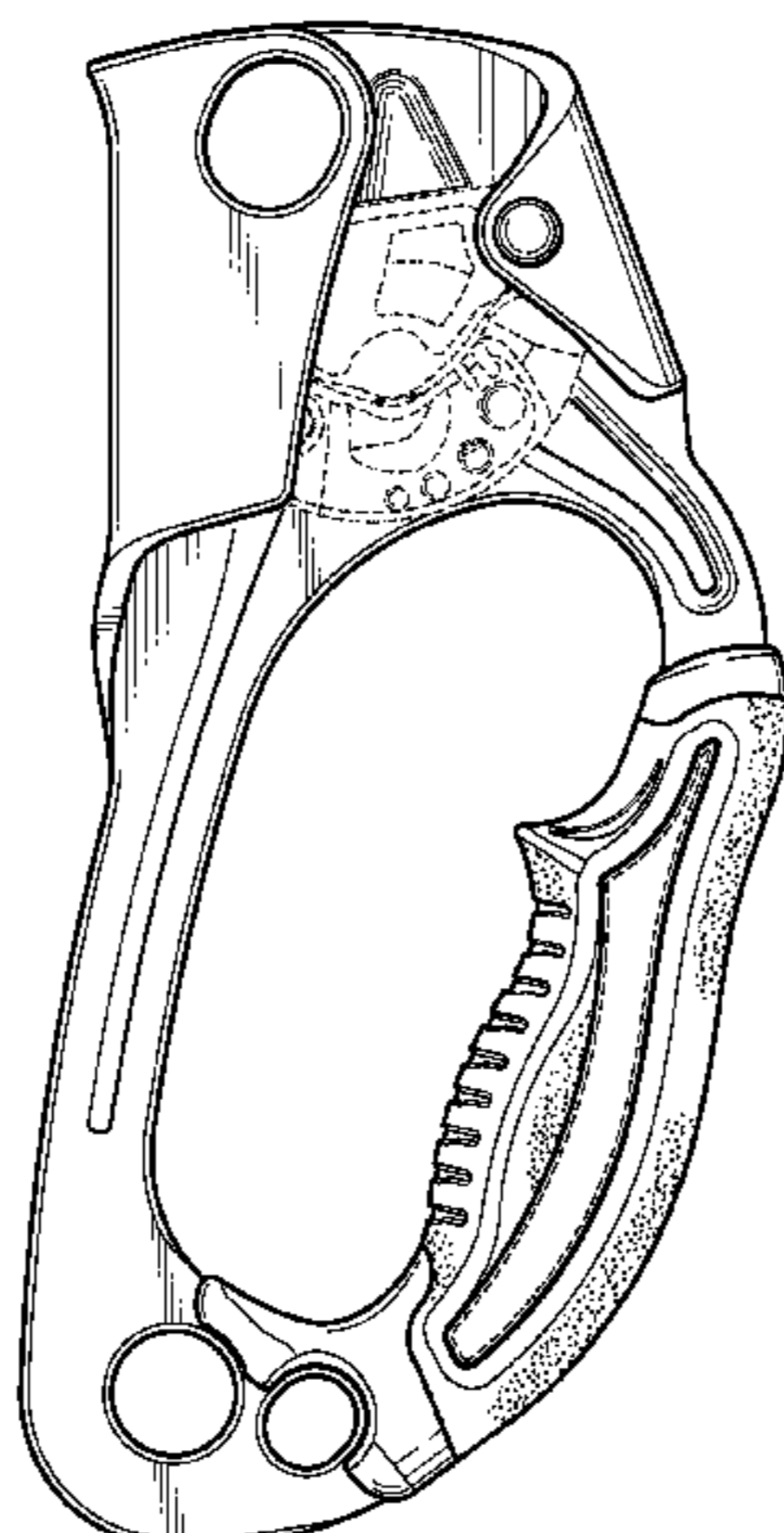

US D614,936 S

Page 2

FOREIGN PATENT DOCUMENTS

FR 2589211 A1 * 4/1987
FR 2740522 * 10/1996
FR 2805577 A1 * 8/2001
FR 2904564 A1 * 2/2008
FR 2919195 A1 * 1/2009
KR 2004105498 A * 12/2004

WO WO 9917839 A1 * 4/1999

OTHER PUBLICATIONS

4 Pages from 2005 Special Operations Equipment Solutions Catalog from ADS, Petzl product images on pp. 12 & 58 # B17 R and B17L found in search of carabiners Aug. 2, 2009.*

* cited by examiner

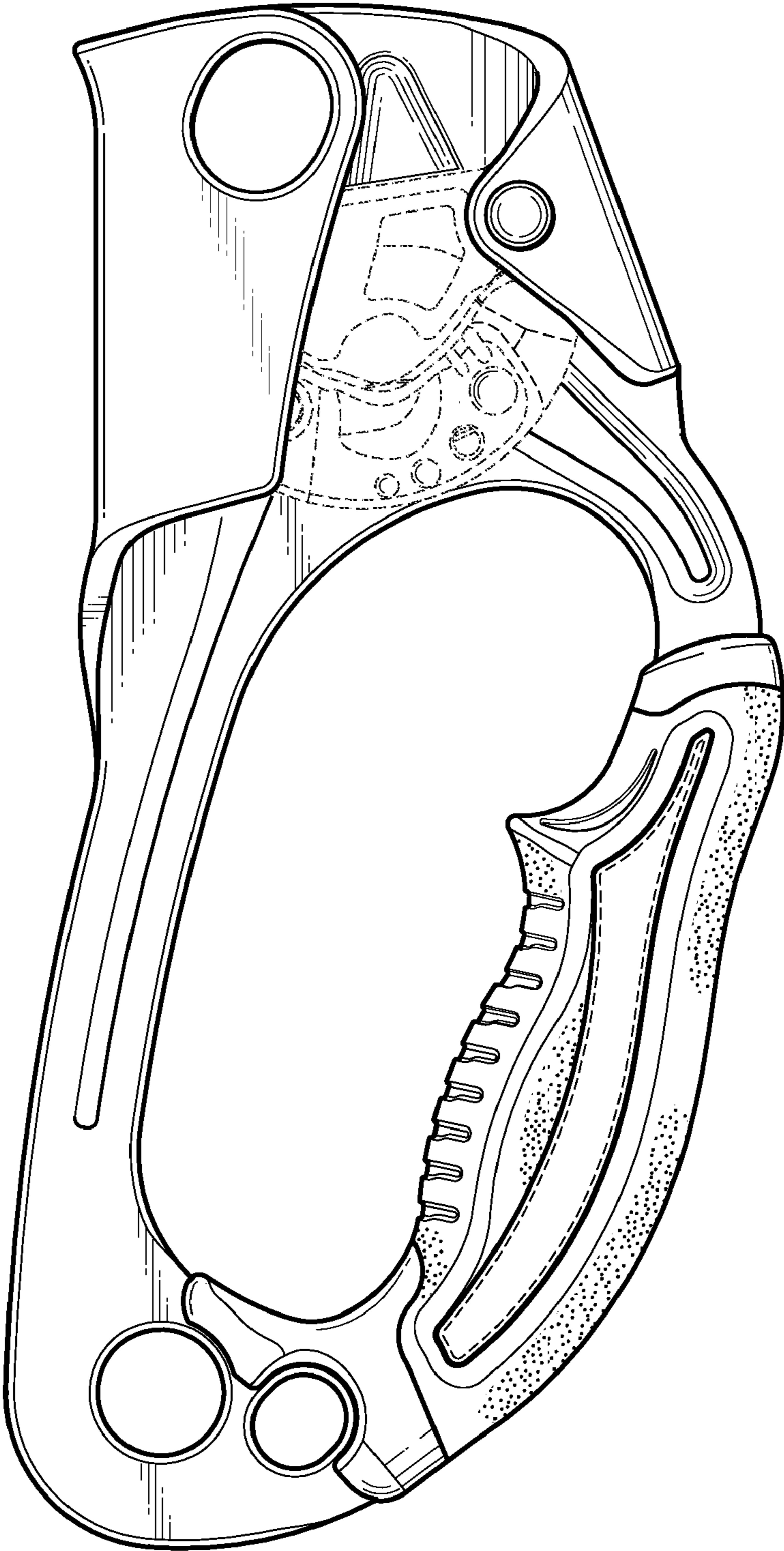

FIG. 1

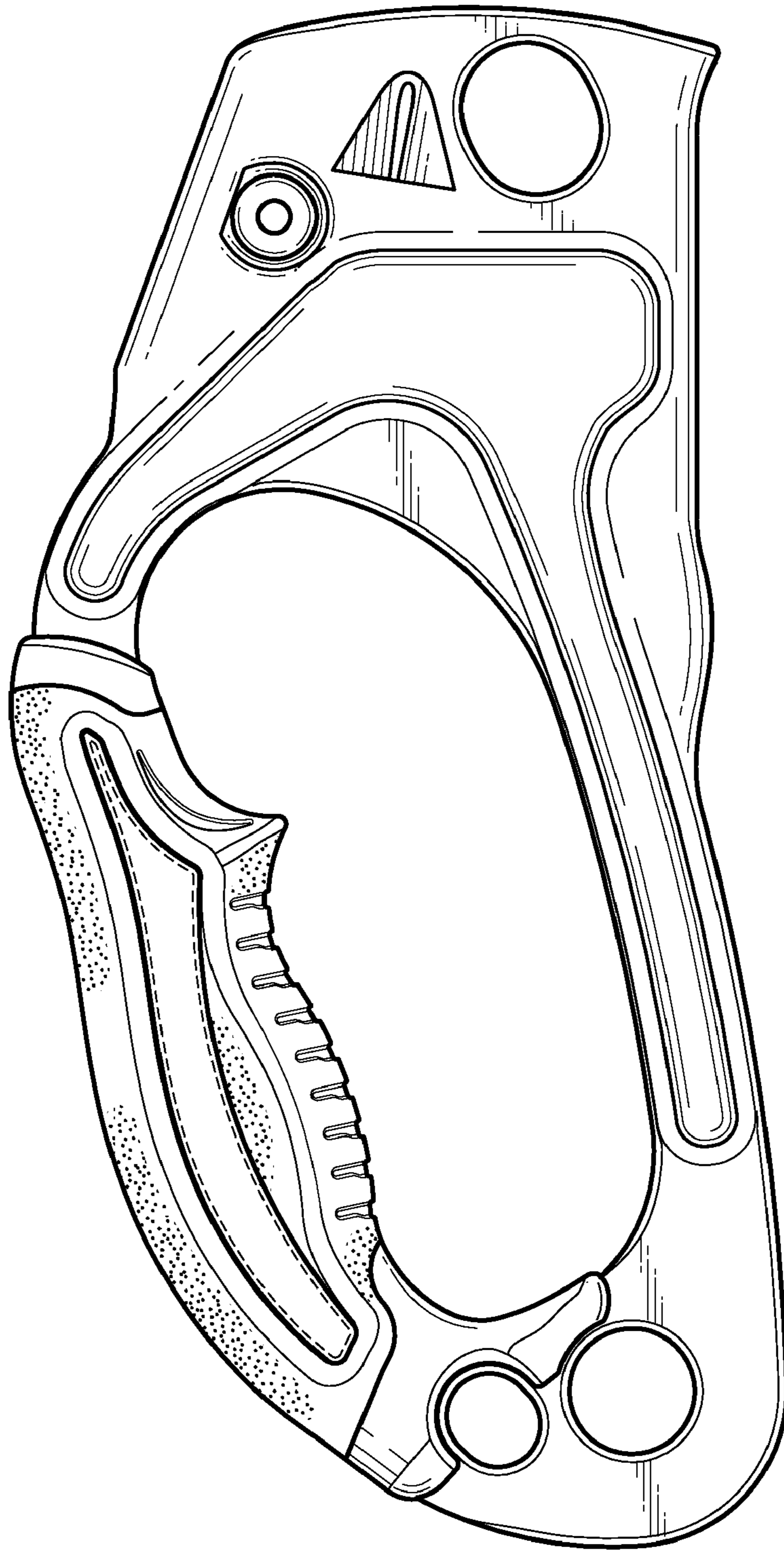

FIG. 2

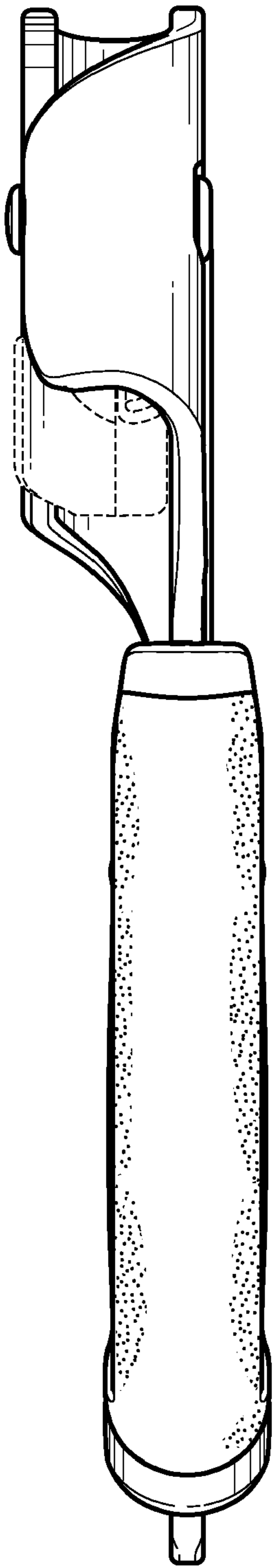

FIG. 3

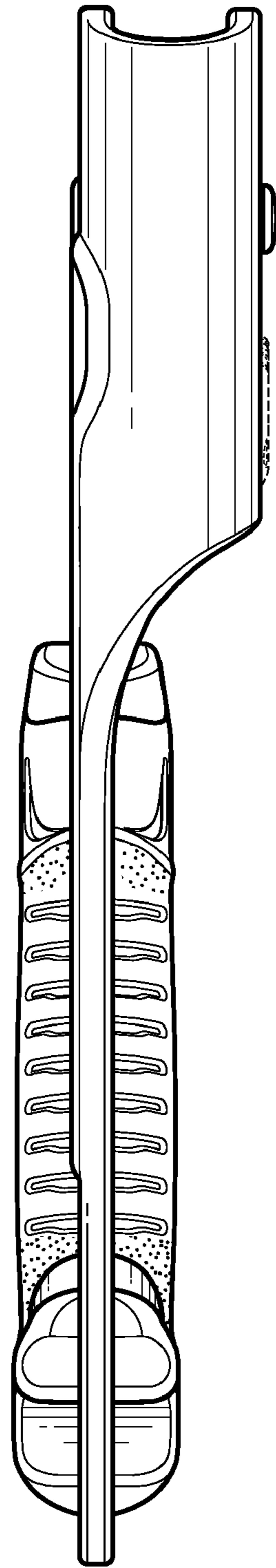

FIG. 4

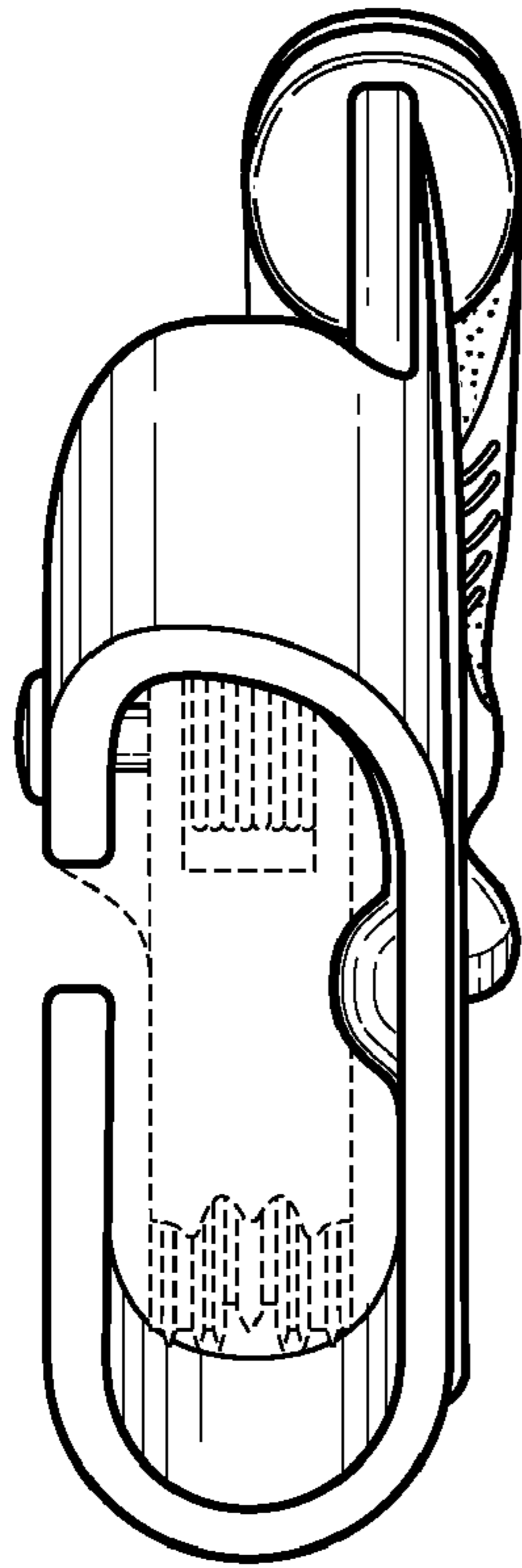

FIG. 5

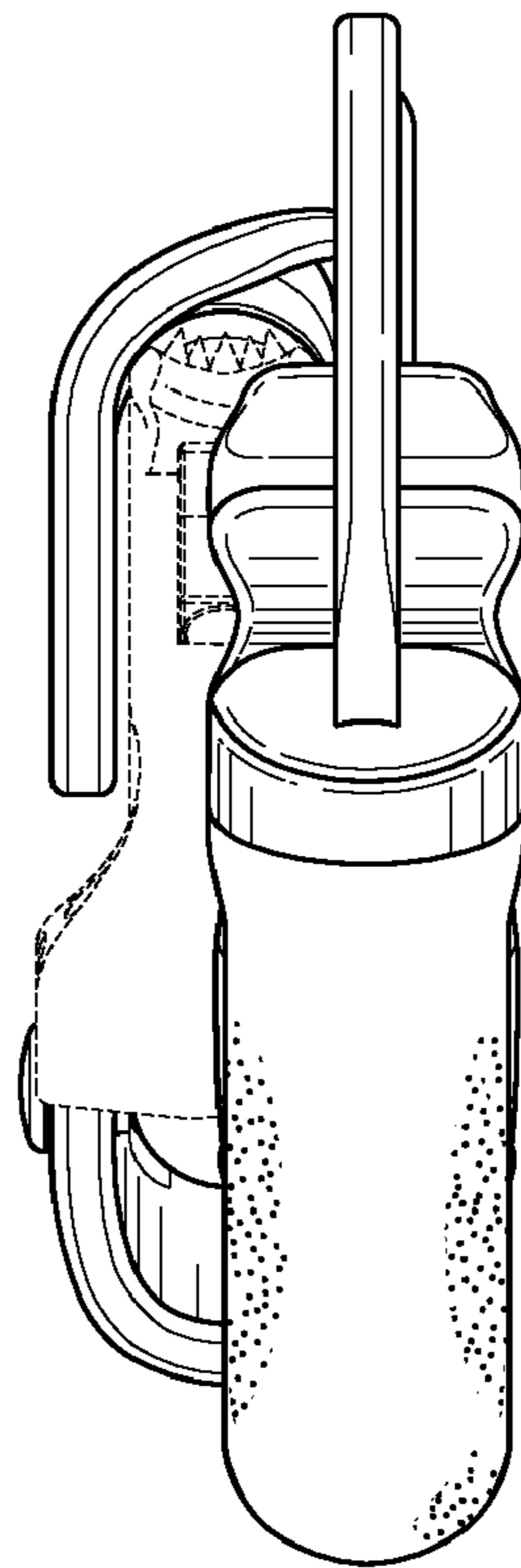

FIG. 6