



US00D614930S

(12) **United States Design Patent**  
**Garcia et al.**

(10) **Patent No.:** **US D614,930 S**

(45) **Date of Patent:** **\*\* May 4, 2010**

(54) **STUBBY SCREWDRIVER HANDLE**

D534,052 S \* 12/2006 Lin ..... D8/107

\* cited by examiner

(75) Inventors: **Michael Garcia**, Oakland Park, FL  
(US); **Glenn Robinson**, Coral Springs,  
FL (US); **Joseph Deguglimo**, Boca  
Raton, FL (US)

*Primary Examiner*—Philip S Hyder  
*Assistant Examiner*—Roselynn Cody  
(74) *Attorney, Agent, or Firm*—Dan M. DeLaRosa

(73) Assignee: **IBT Holdings, Inc.**, Deerfield Beach, FL  
(US)

(57) **CLAIM**

The ornamental design for a stubby screwdriver handle, as shown and described.

(\*\*) Term: **14 Years**

(21) Appl. No.: **29/312,940**

**DESCRIPTION**

(22) Filed: **Nov. 24, 2008**

FIG. 1 is a right side perspective view of the stubby screwdriver handle of the present invention showing the new design.

(51) **LOC (9) Cl.** ..... **08-04**

(52) **U.S. Cl.** ..... **D8/83**

(58) **Field of Classification Search** ..... D8/82-87,  
D8/107; 16/110.1; 81/177.1, 177.4, 436-440,  
81/489

FIG. 2 is a left side perspective view thereof;

FIG. 3 is a top plan view thereof;

FIG. 4 is bottom plan view thereof;

FIG. 5 is a front elevational view thereof;

FIG. 6 is a rear elevational view thereof;

FIG. 7 is a right side elevational view thereof; and,

FIG. 8 is a left side elevational view thereof.

See application file for complete search history.

The broken lines in the drawings illustrate aspects of the design that form no part of the claim.

(56) **References Cited**

**U.S. PATENT DOCUMENTS**

D431,989 S \* 10/2000 Lai ..... D8/83

D494,824 S \* 8/2004 Hernandez ..... D8/47

D532,277 S \* 11/2006 Shih ..... D8/107

D532,278 S \* 11/2006 Shih ..... D8/107

**1 Claim, 5 Drawing Sheets**

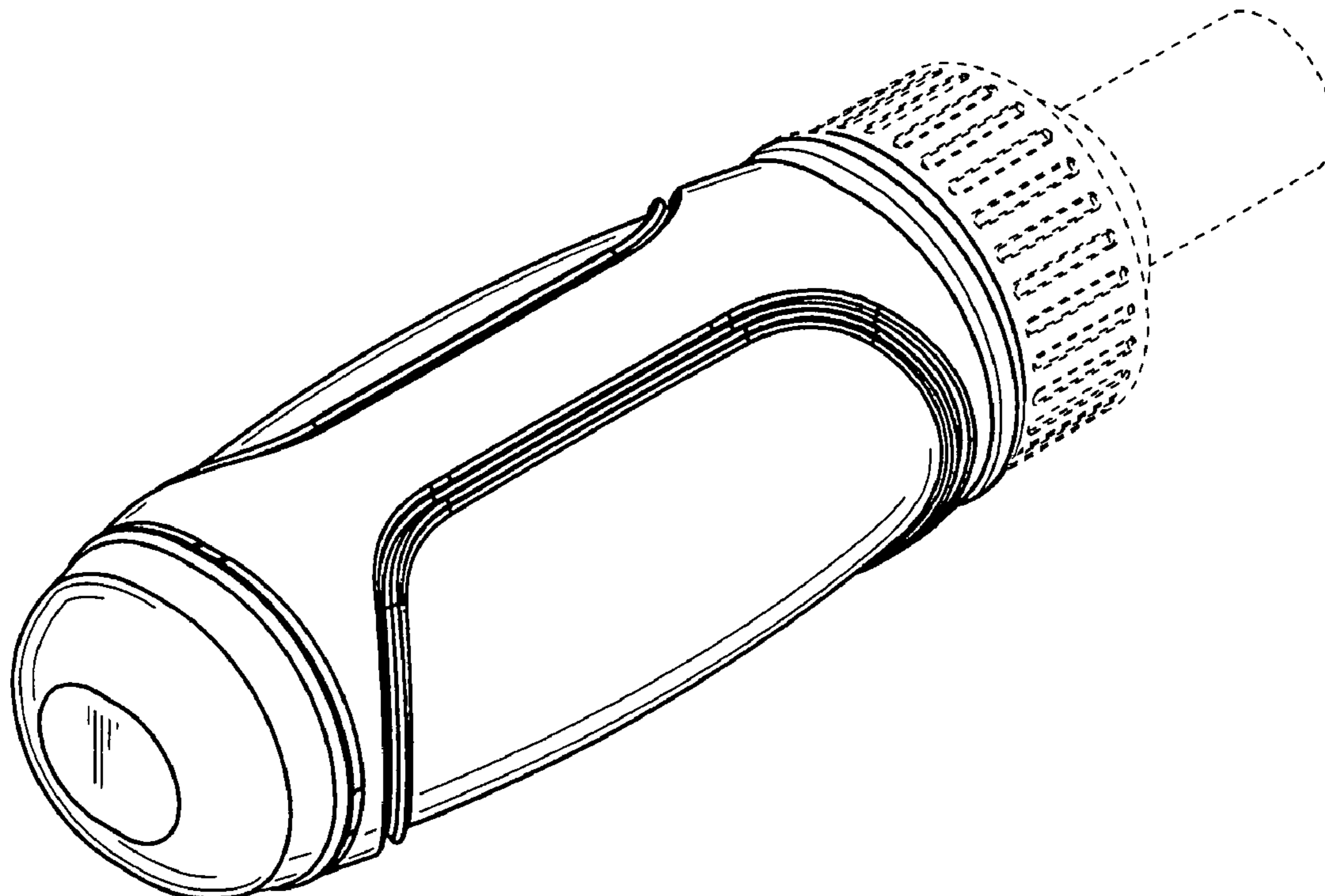

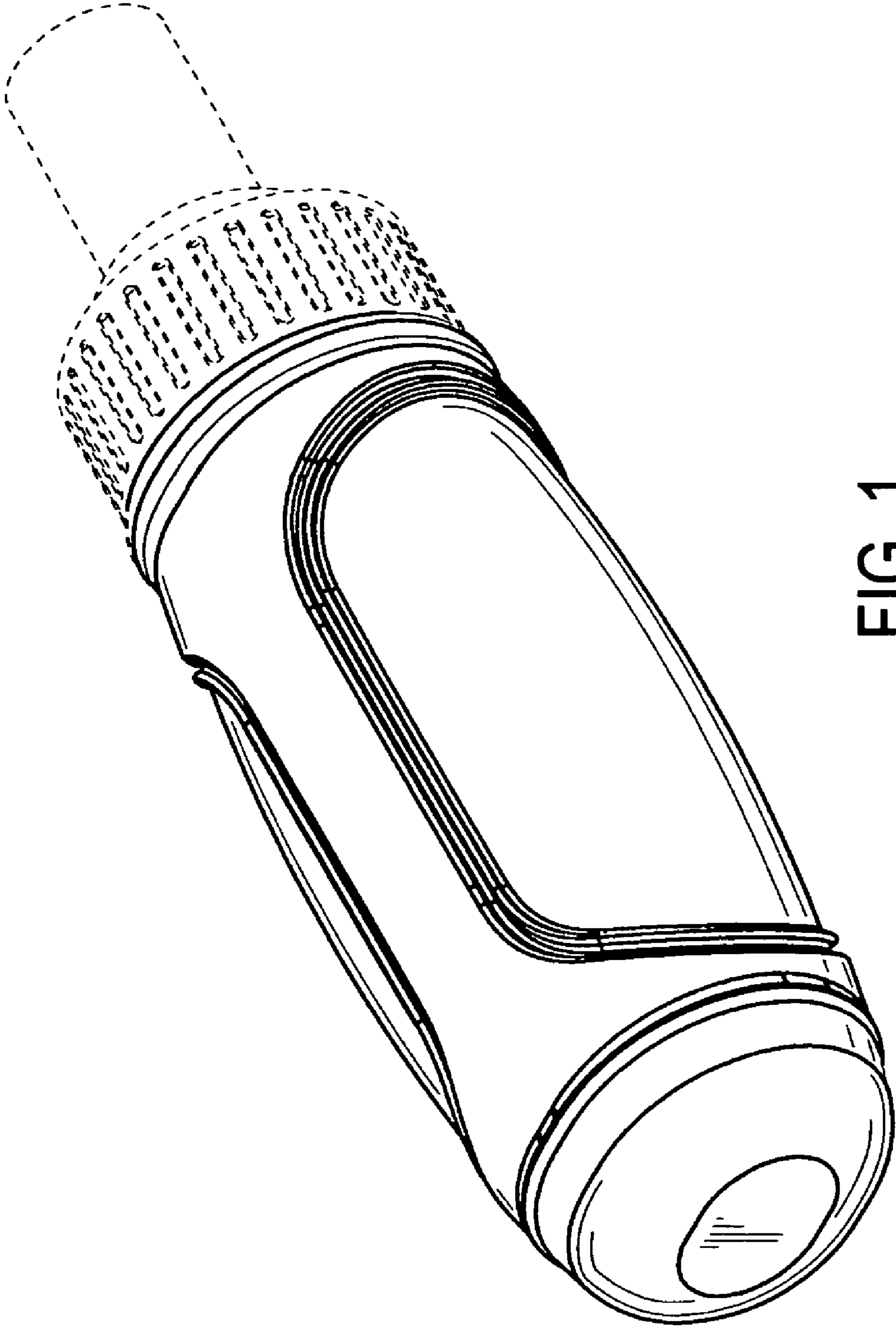

FIG. 1

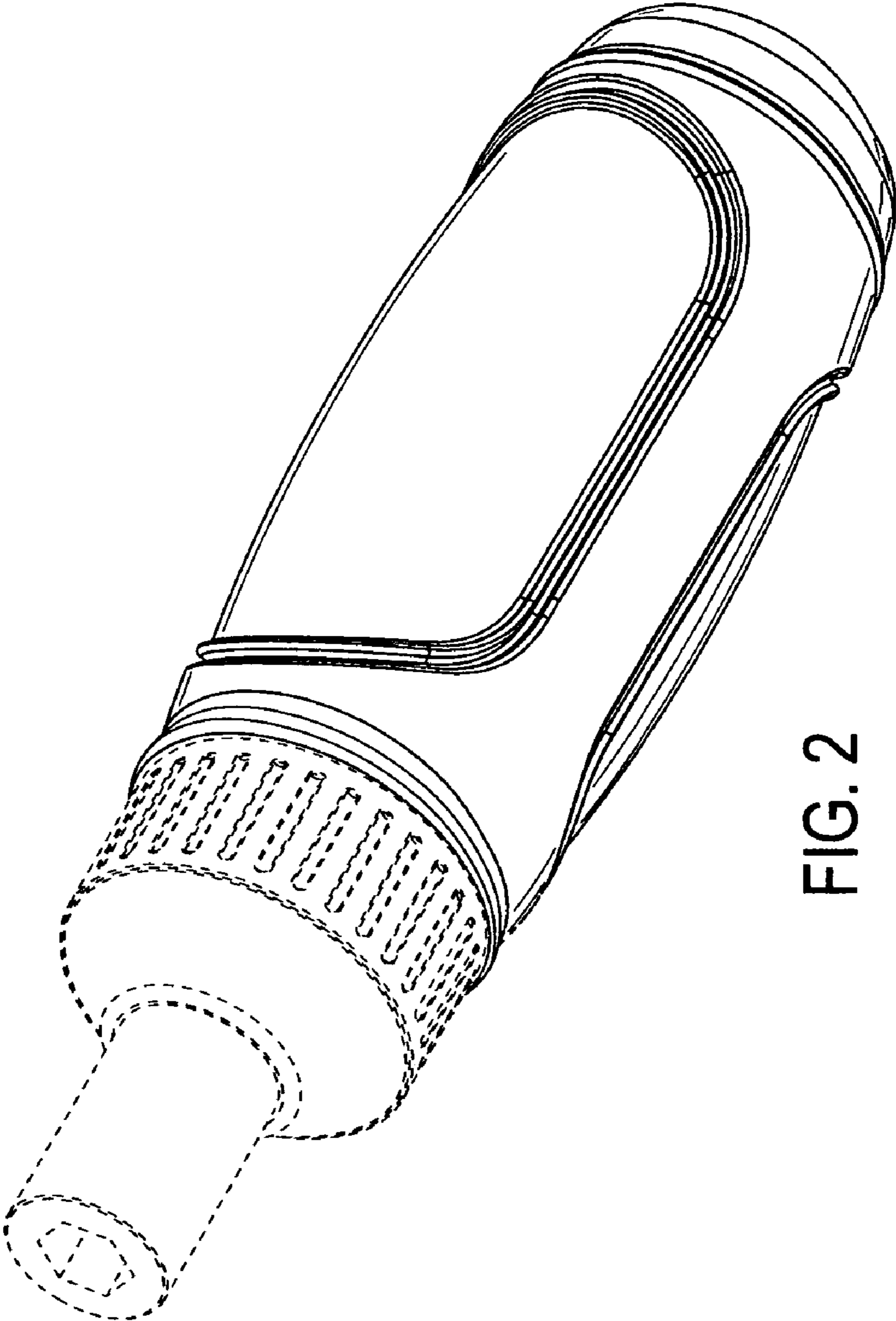

FIG. 2

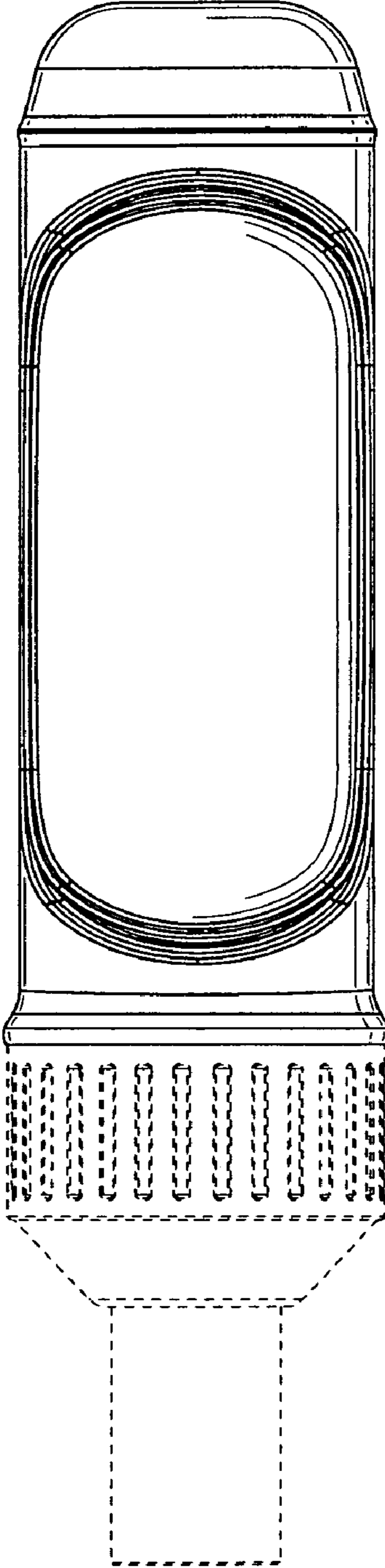

FIG. 3

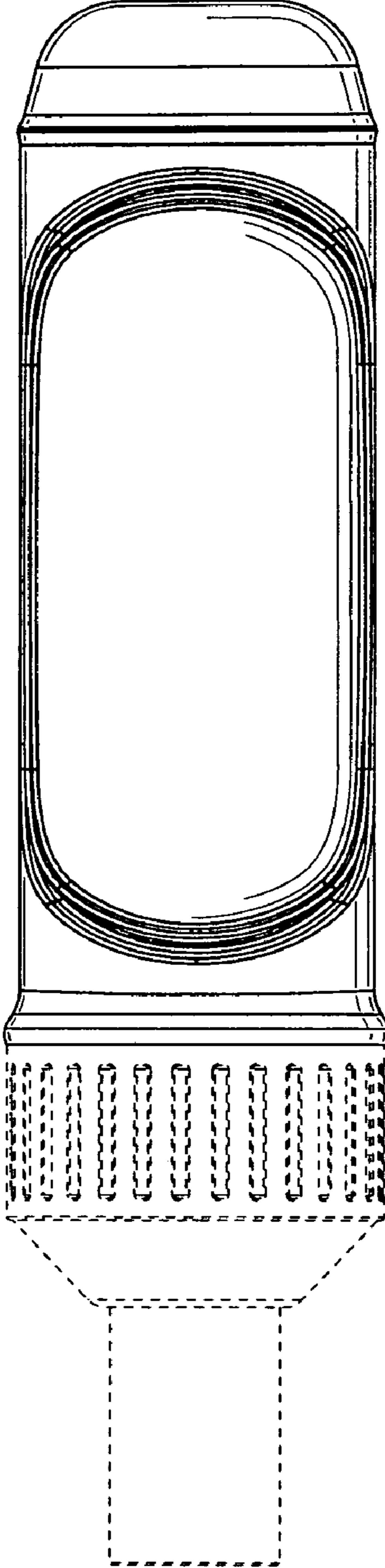

FIG. 4

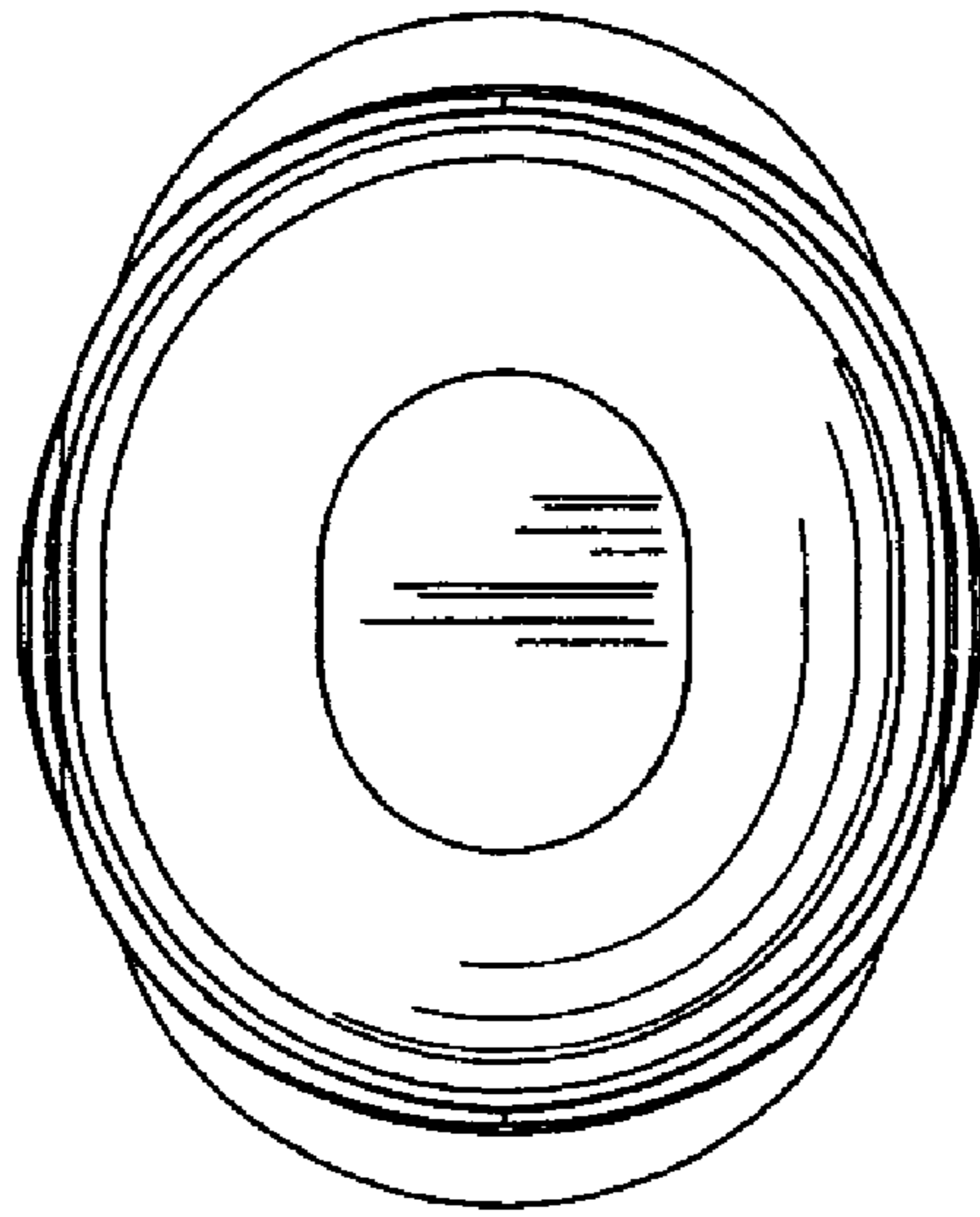

FIG. 6

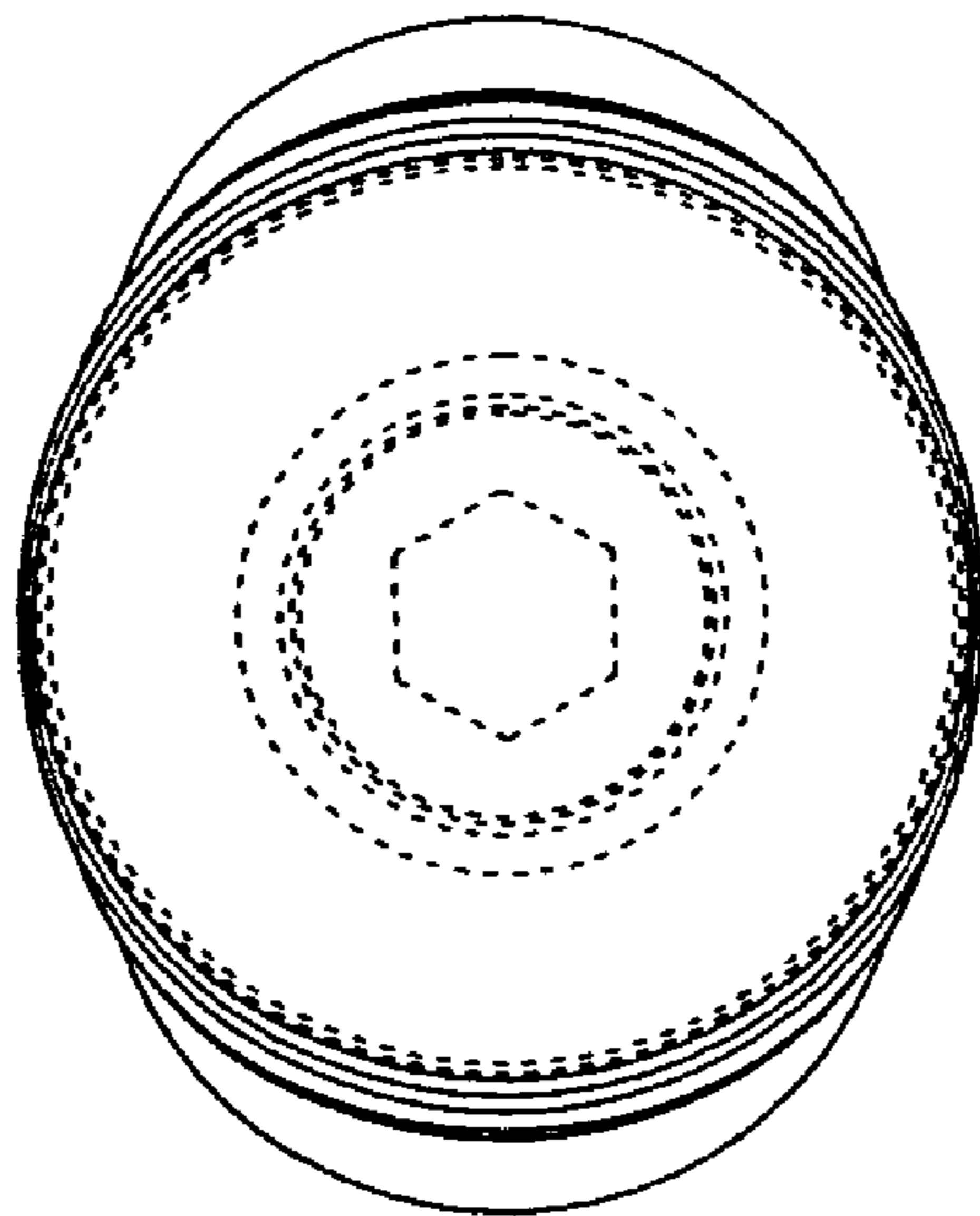

FIG. 5



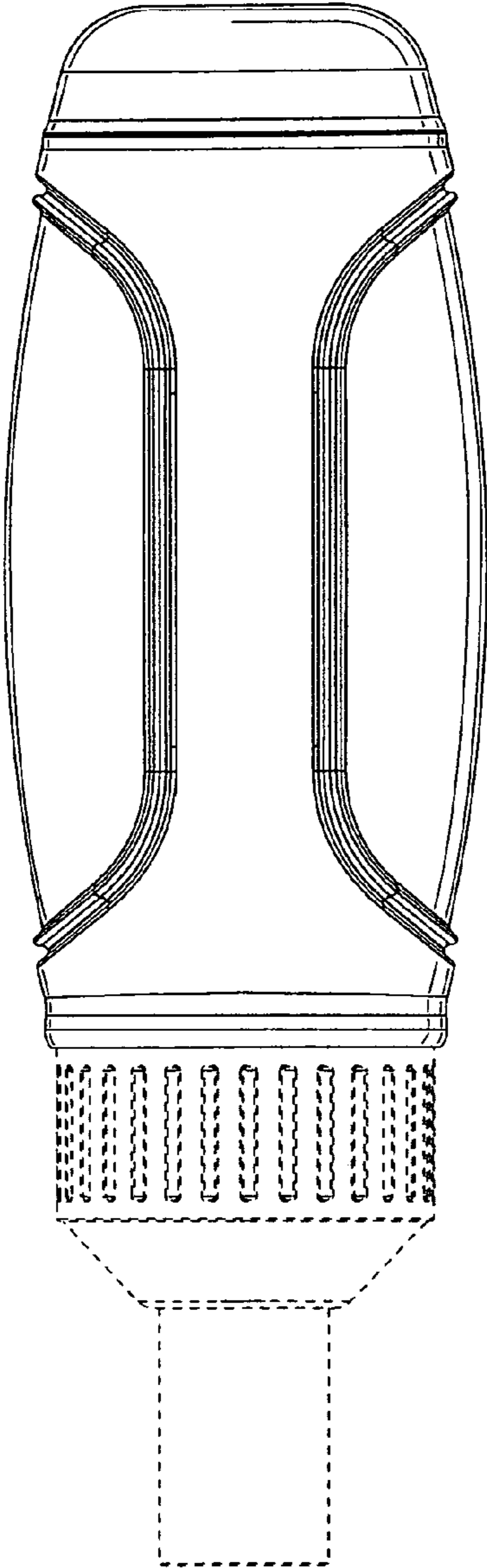

FIG. 7

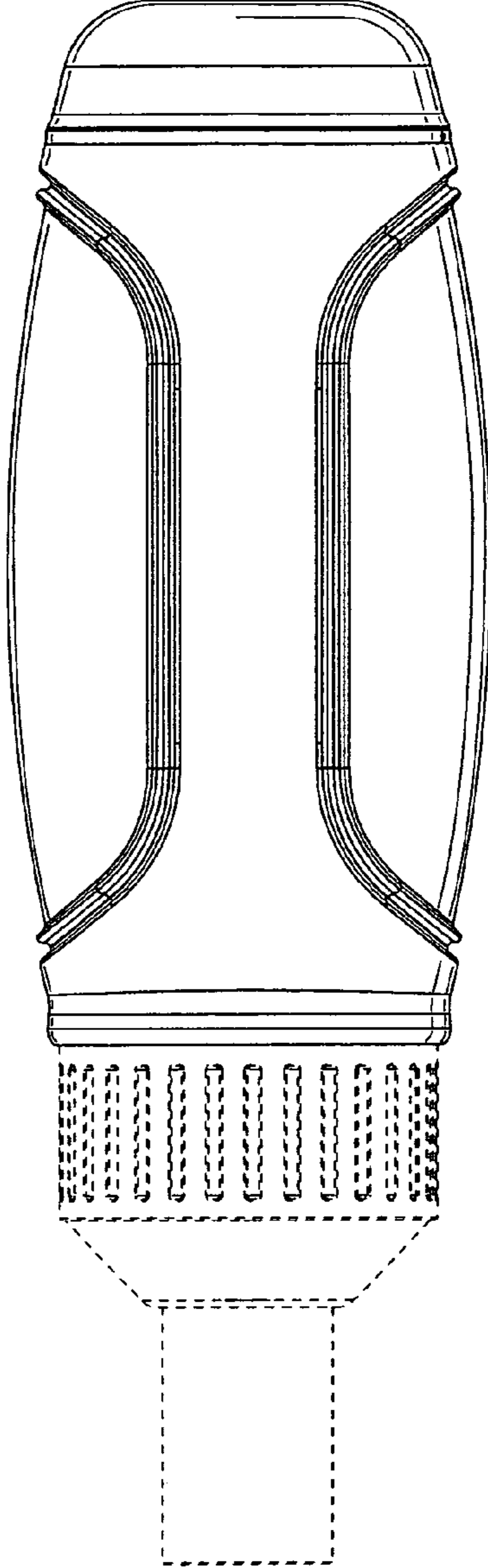

FIG. 8