



US00D614885S

(12) **United States Design Patent**
Haaf, Jr.

(10) **Patent No.:** **US D614,885 S**
(45) **Date of Patent:** **** May 4, 2010**

(54) **BENCH SUPPORT**

(75) Inventor: **James D. Haaf, Jr.**, Odessa, FL (US)

(73) Assignee: **Metropolitan Advertising Company**,
Tampa, FL (US)

(**) Term: **14 Years**

(21) Appl. No.: **29/350,605**

(22) Filed: **Nov. 19, 2009**

(51) **LOC (9) Cl.** **06-01**

(52) **U.S. Cl.** **D6/381**

(58) **Field of Classification Search** D6/334,
D6/336, 369, 374, 491, 492, 495, 500-502;
297/63, 94, 232, 233, 248, 283.1, 283.2,
297/535, 354.1, 445.1, 446.1, 448.1; 5/12.1,
5/12.2

See application file for complete search history.

(56) **References Cited**

U.S. PATENT DOCUMENTS

D294,782 S *	3/1988	Balderi	D6/373
D376,937 S *	12/1996	Skalka	D6/492
D383,615 S *	9/1997	Skalka	D6/370
D384,512 S *	10/1997	Skalka	D6/370
D386,012 S *	11/1997	Skalka	D6/370
D419,004 S *	1/2000	Collins	D6/492
D458,475 S *	6/2002	Hecht et al.	D6/492
D468,126 S *	1/2003	Pappas	D6/381
D564,802 S *	3/2008	Weimer et al.	D6/492
D572,048 S *	7/2008	Weimer et al.	D6/492

* cited by examiner

Primary Examiner—Sandra Snapp

(74) *Attorney, Agent, or Firm*—Eric R. Pellenburg; Phelps Dunbar LLP

(57) **CLAIM**

The ornamental design for a bench support, as shown and described.

DESCRIPTION

FIG. 1 is a perspective view of a bench support having a left bench side support and a right bench side support comprising my new design;

FIG. 2 is a perspective view of a bench support comprising my design;

FIG. 3 is a left side elevation view of a left bench side support comprising my design;

FIG. 4 is a right side elevation view of a left bench side support comprising my design;

FIG. 5 is a front end elevation view of a left bench side support comprising my design;

FIG. 6 is a rear end elevation view of a left bench side support comprising my design;

FIG. 7 is a top plan view of a left bench side support comprising my design;

FIG. 8 is a bottom plan view of a left bench side support comprising my design;

FIG. 9 is a left side elevation view of a right bench side support comprising my design;

FIG. 10 is a right side elevation view of a right bench side support comprising my design;

FIG. 11 is a front end elevation view of a right bench side support comprising my design;

FIG. 12 is a rear end elevation view of a right bench side support comprising my design;

FIG. 13 is a top plan view of a right bench side support comprising my design; and,

FIG. 14 is a bottom plan view of a right bench side support comprising my design.

The broken lines shown in the drawings are for illustrative purposes only and form no part of the claimed design.

1 Claim, 3 Drawing Sheets

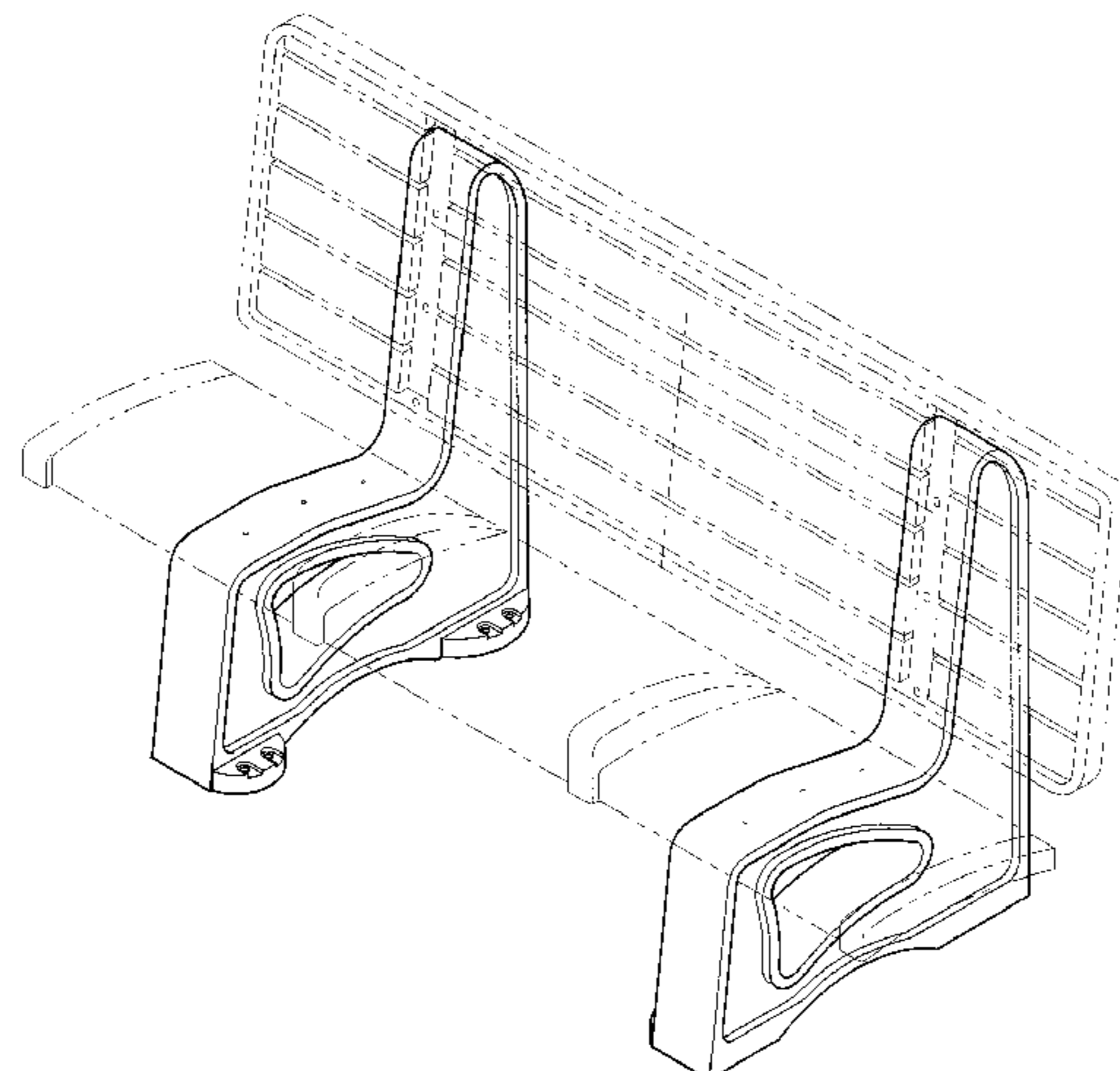

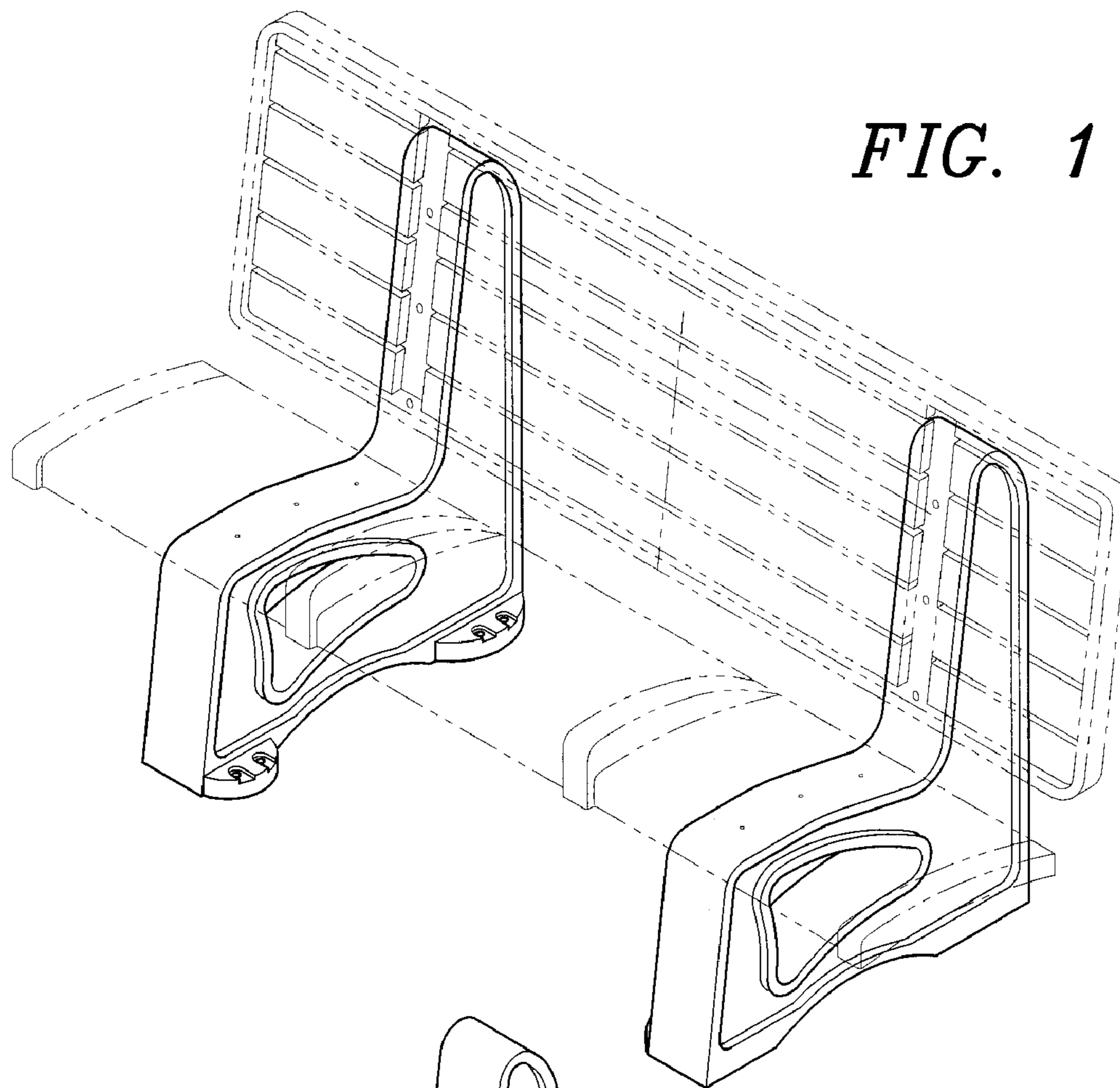

FIG. 1

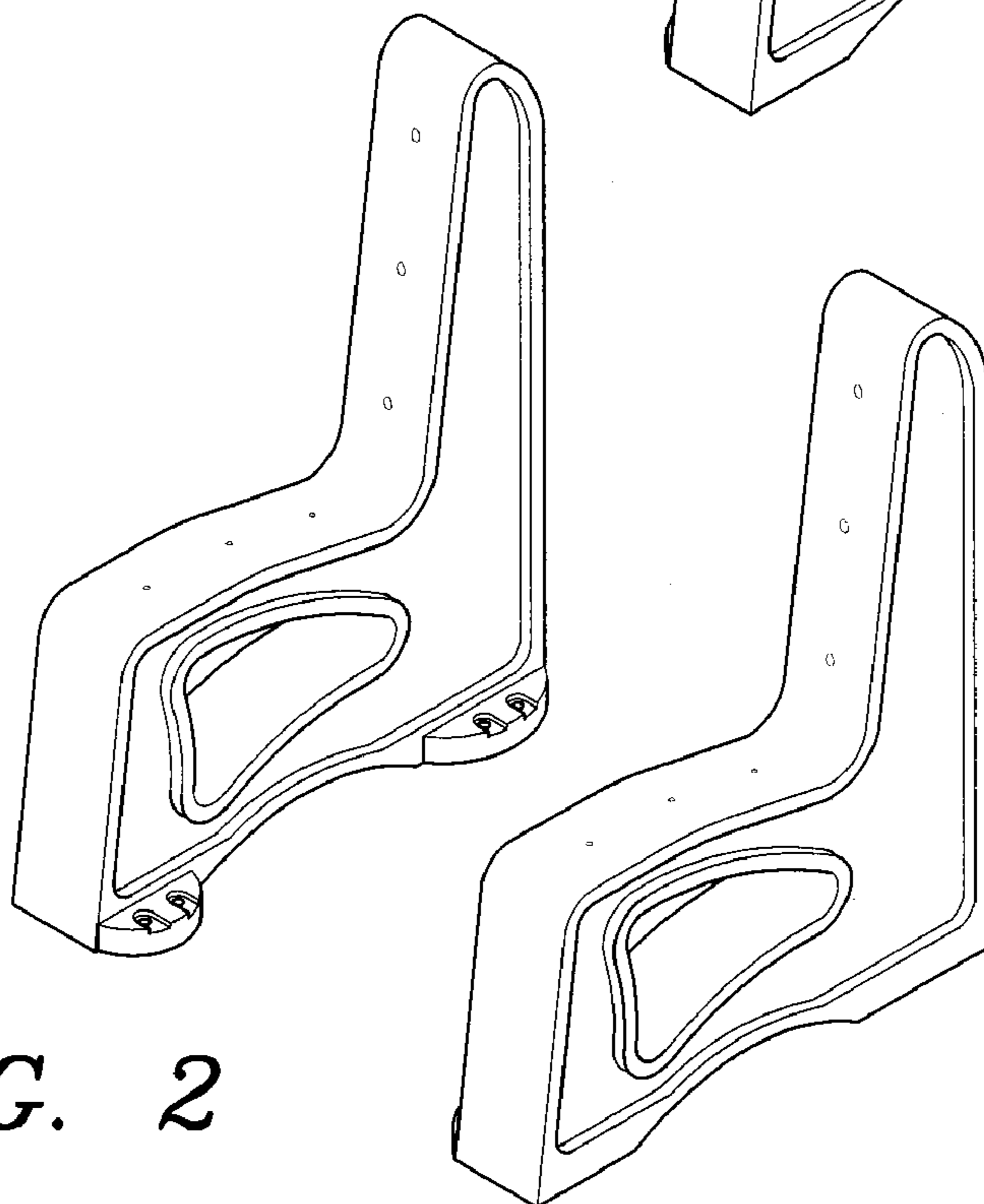

FIG. 2

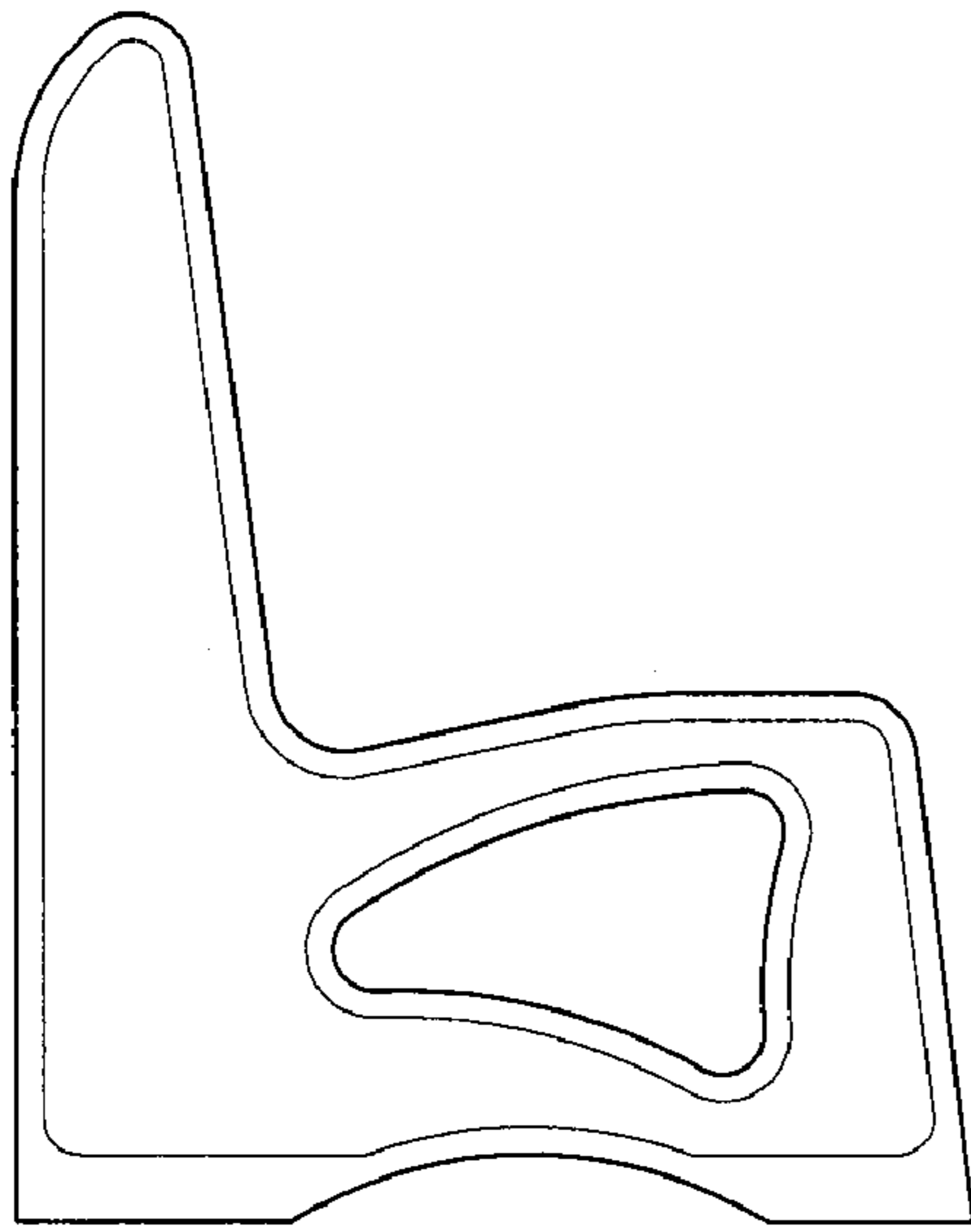

FIG. 3

FIG. 4

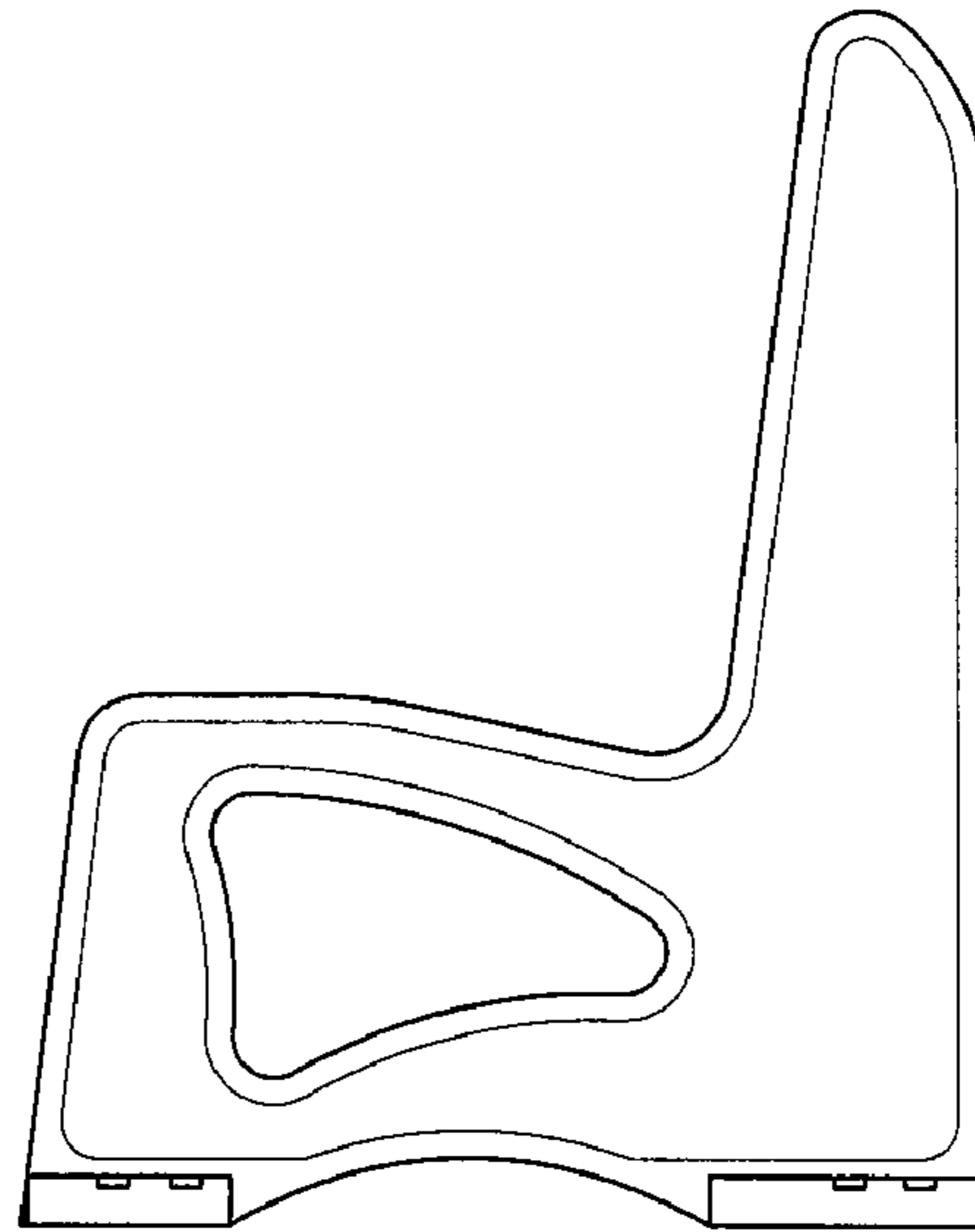

FIG. 5

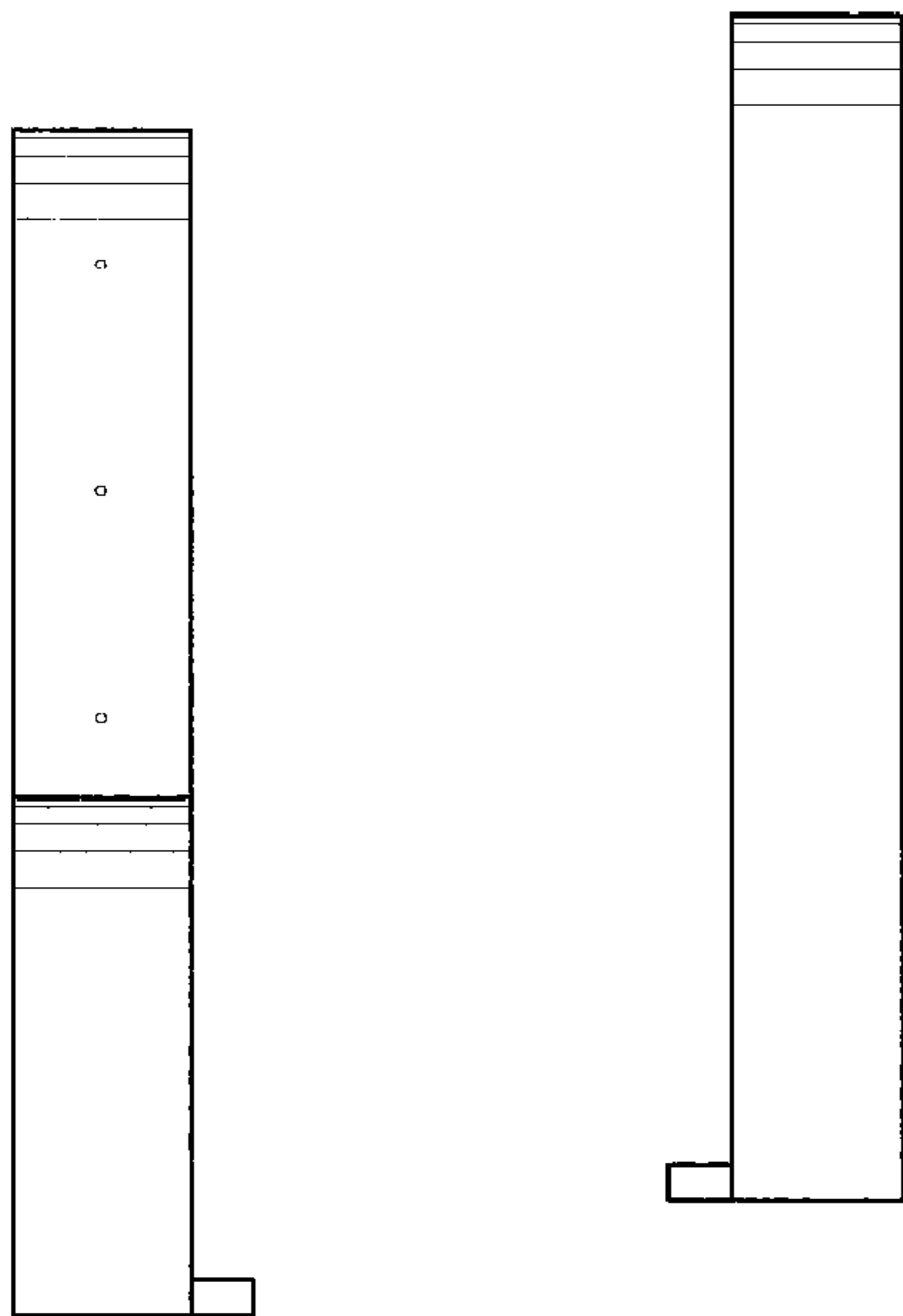

FIG. 6

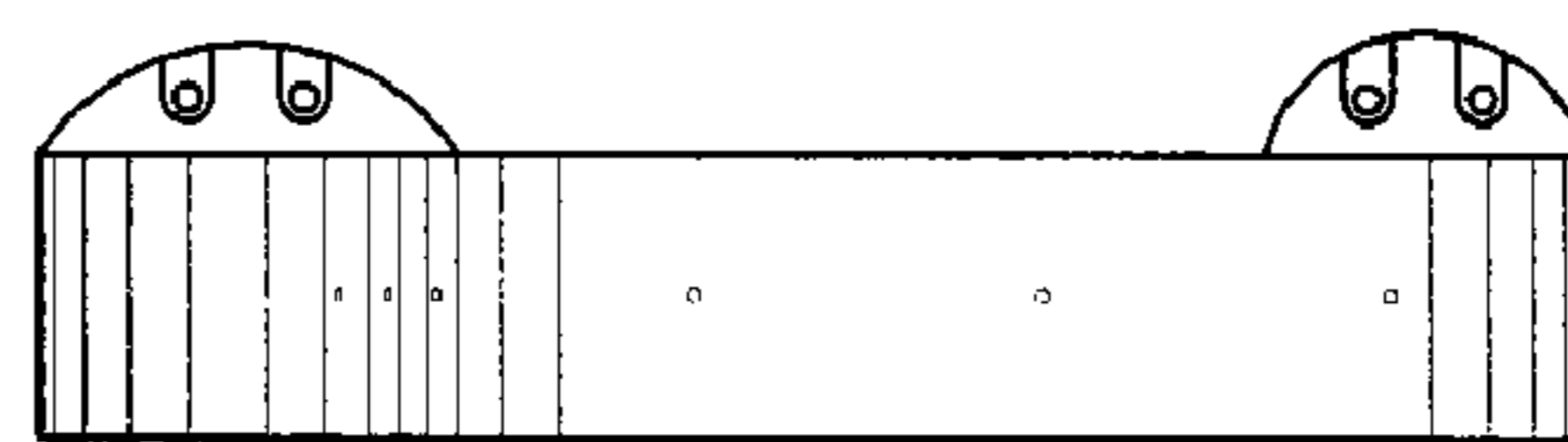

FIG. 7

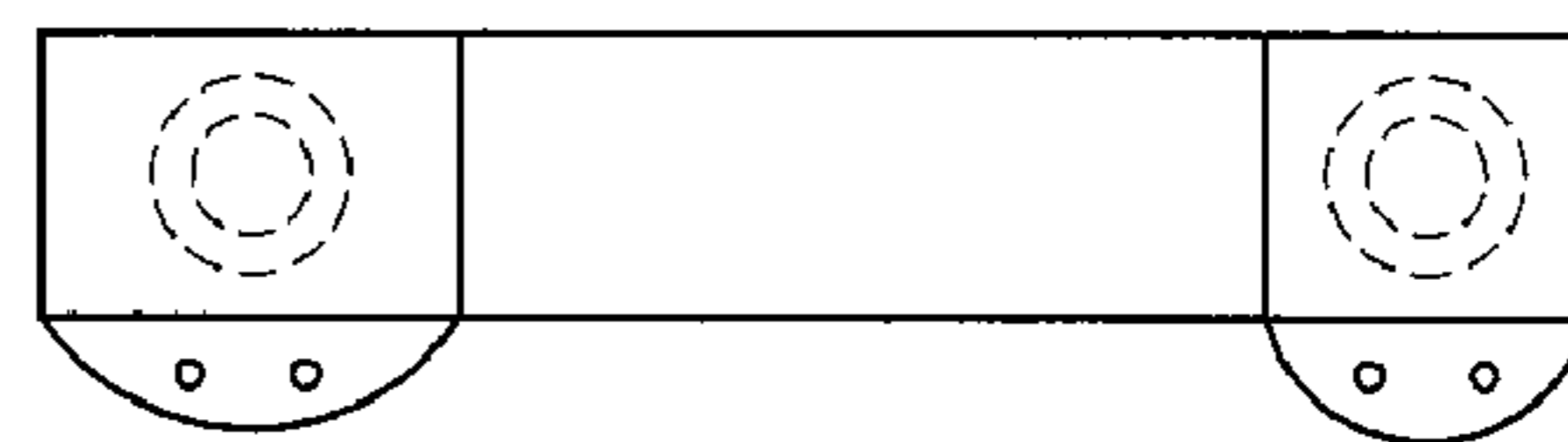

FIG. 8

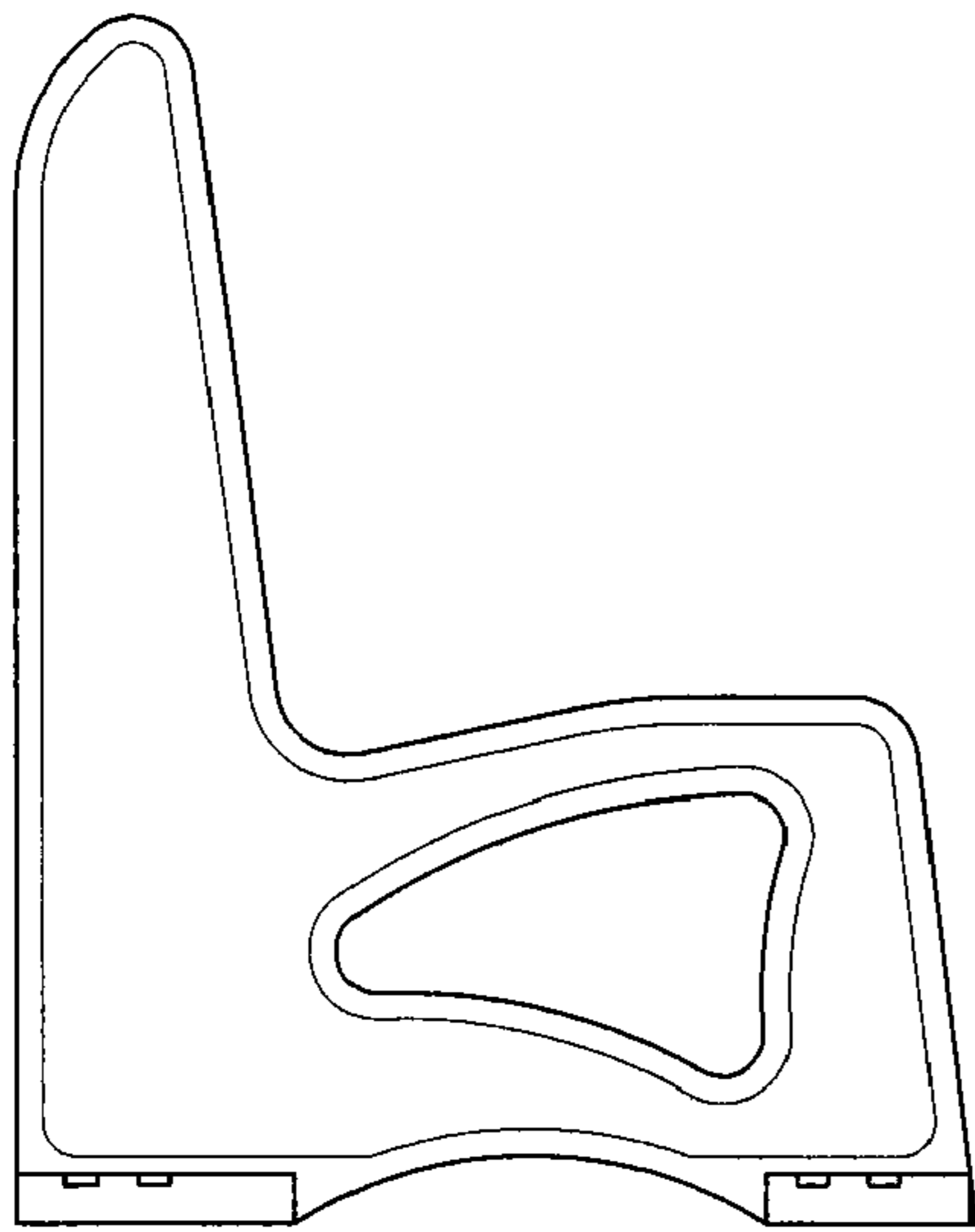

FIG. 9

FIG. 10

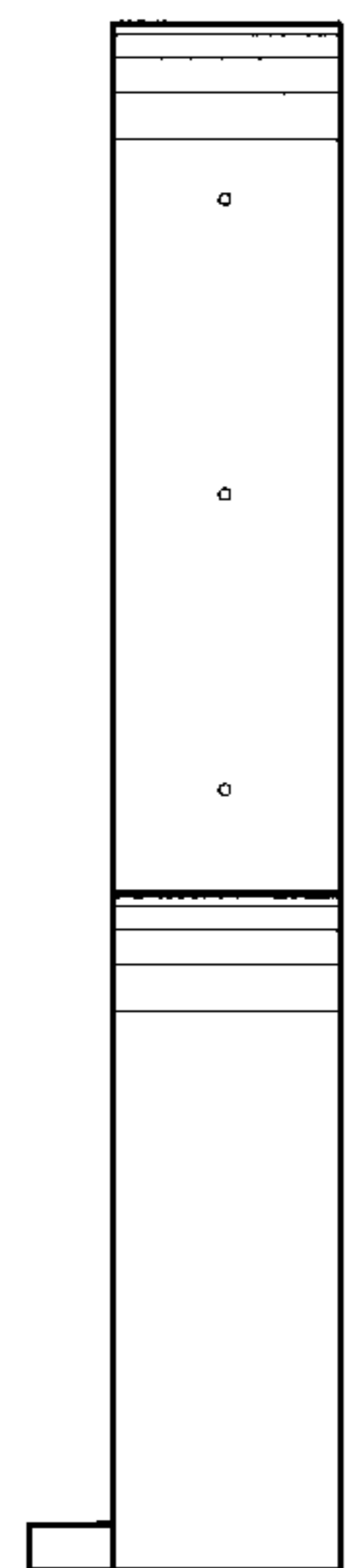
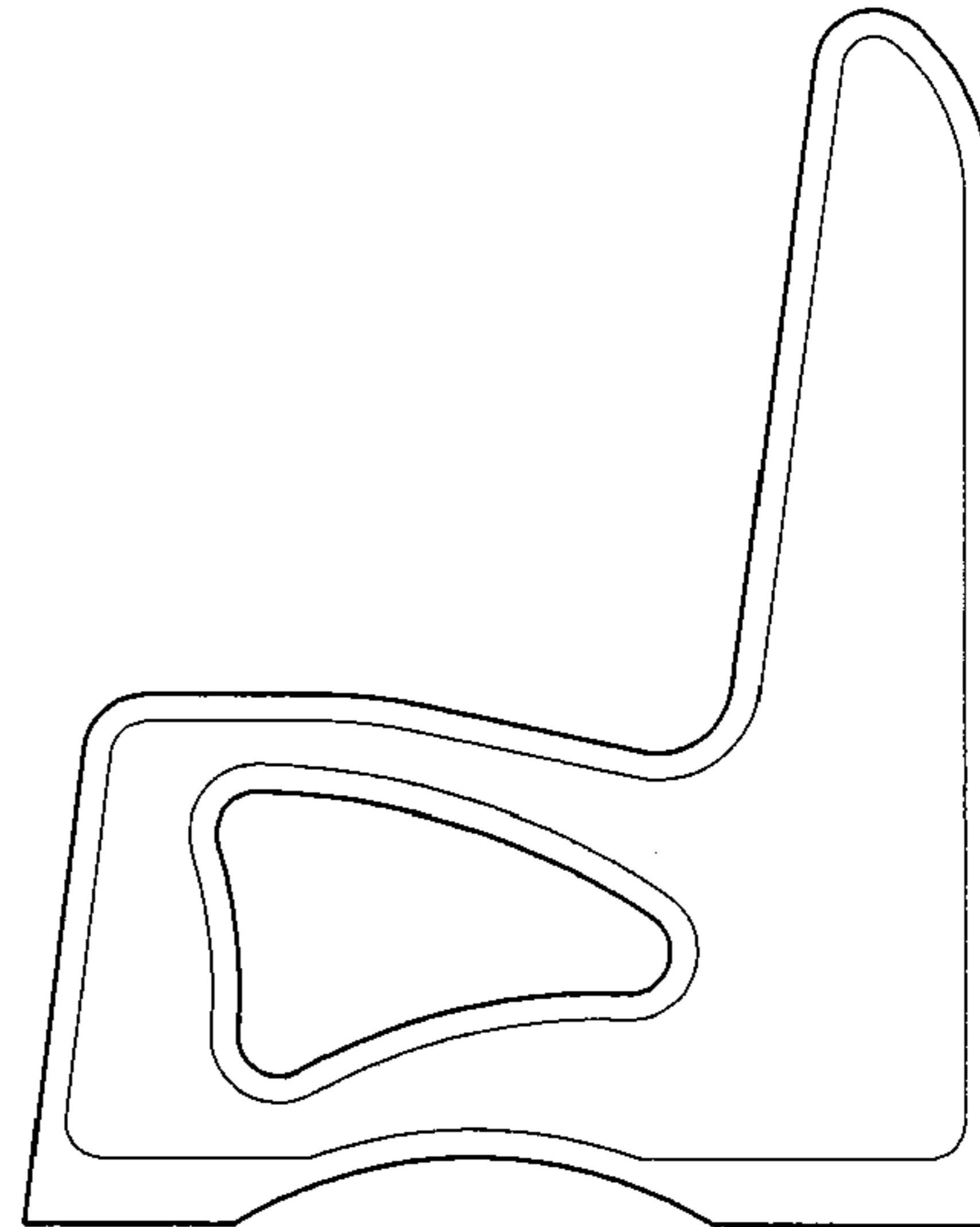

FIG. 11

FIG. 12

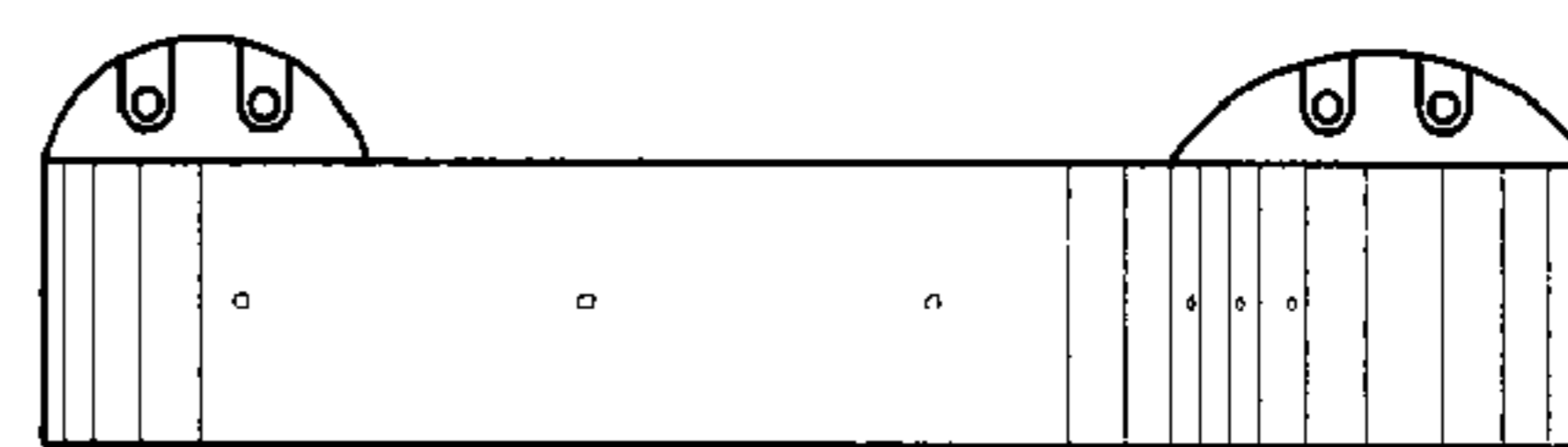
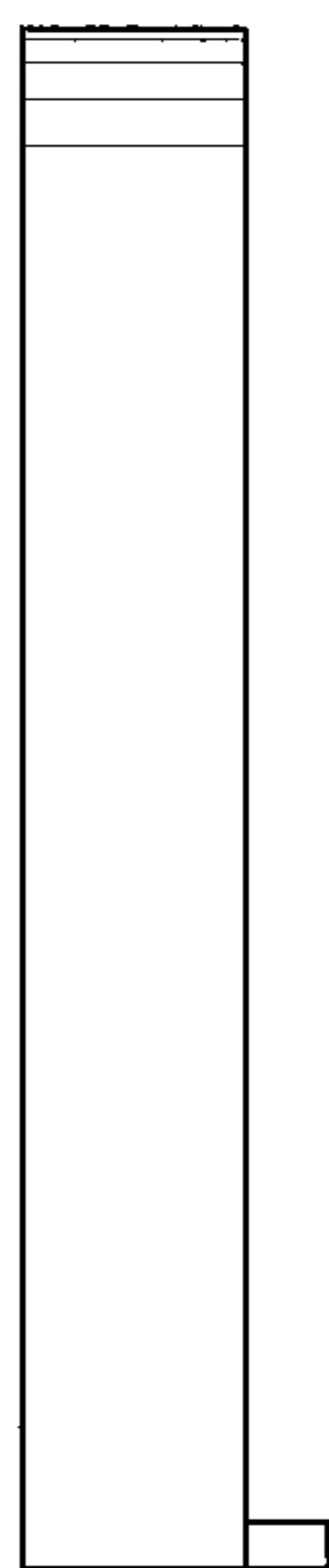

FIG. 13

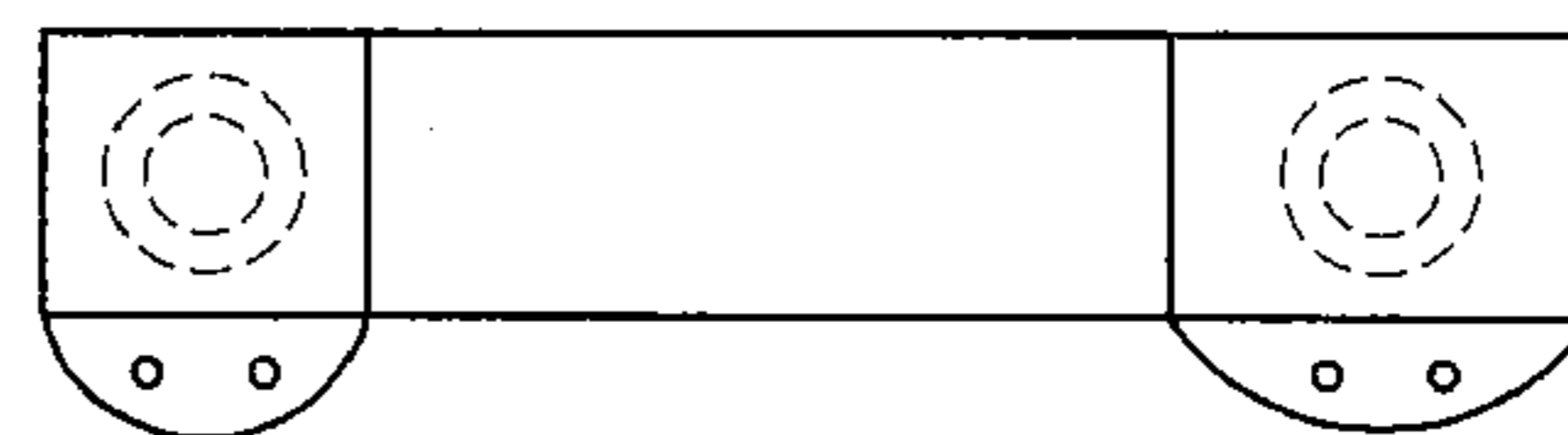

FIG. 14