



US00D614836S

(12) **United States Design Patent**
Kay et al.

(10) **Patent No.:** **US D614,836 S**

(45) **Date of Patent:** **** May 4, 2010**

(54) **COVER FOR CLEATED SHOE**

(75) Inventors: **Marianne Kay**, Encinitas, CA (US);
Richard Kay, Encinitas, CA (US)

(73) Assignee: **Cleatskins**, Encinitas, CA (US)

(**) Term: **14 Years**

(21) Appl. No.: **29/338,141**

(22) Filed: **Jun. 5, 2009**

(51) **LOC (9) Cl.** **02-04**

(52) **U.S. Cl.** **D2/914; D2/958**

(58) **Field of Classification Search** D2/896,
D2/902, 907-909, 914, 916, 917, 946, 955,
D2/958, 969; 36/45, 7.3, 77 R, 50.1, 83,
36/88, 113, 114, 126-130, 22 R, 25 R, 28
See application file for complete search history.

(56) **References Cited**

U.S. PATENT DOCUMENTS

5,548,910	A	*	8/1996	Klingseis	36/135
D376,895	S	*	12/1996	Cook	D2/916
D400,694	S	*	11/1998	Kang	D2/919
D401,050	S	*	11/1998	Greenberg	D2/969
D403,493	S	*	1/1999	McKinley	D2/900
D414,019	S	*	9/1999	Kang	D2/916
D454,425	S	*	3/2002	Boncutter	D2/919

D462,826	S	*	9/2002	Leong et al.	D2/919
D467,407	S	*	12/2002	Berg et al.	D2/916
D485,970	S	*	2/2004	Magro	D2/916
D485,972	S	*	2/2004	Magro	D2/916
D512,821	S	*	12/2005	Lee	D2/958
D548,430	S	*	8/2007	Hulcy	D2/909
D549,934	S	*	9/2007	Horne et al.	D2/951

* cited by examiner

Primary Examiner—Stella M Reid

Assistant Examiner—Rashida C McCoy

(74) *Attorney, Agent, or Firm*—Cantor Colburn LLP

(57) **CLAIM**

We claim, the ornamental design for a cover for cleated shoe, as shown and described.

DESCRIPTION

FIG. 1 is a perspective view of a cover for cleated shoe, showing our new design,

FIG. 2 is a top plan view thereof;

FIG. 3 is a bottom plan view thereof;

FIG. 4 is a side view thereof;

FIG. 5 is an opposite side view thereof;

FIG. 6 is a front view thereof; and,

FIG. 7 is a rear view thereof.

1 Claim, 7 Drawing Sheets

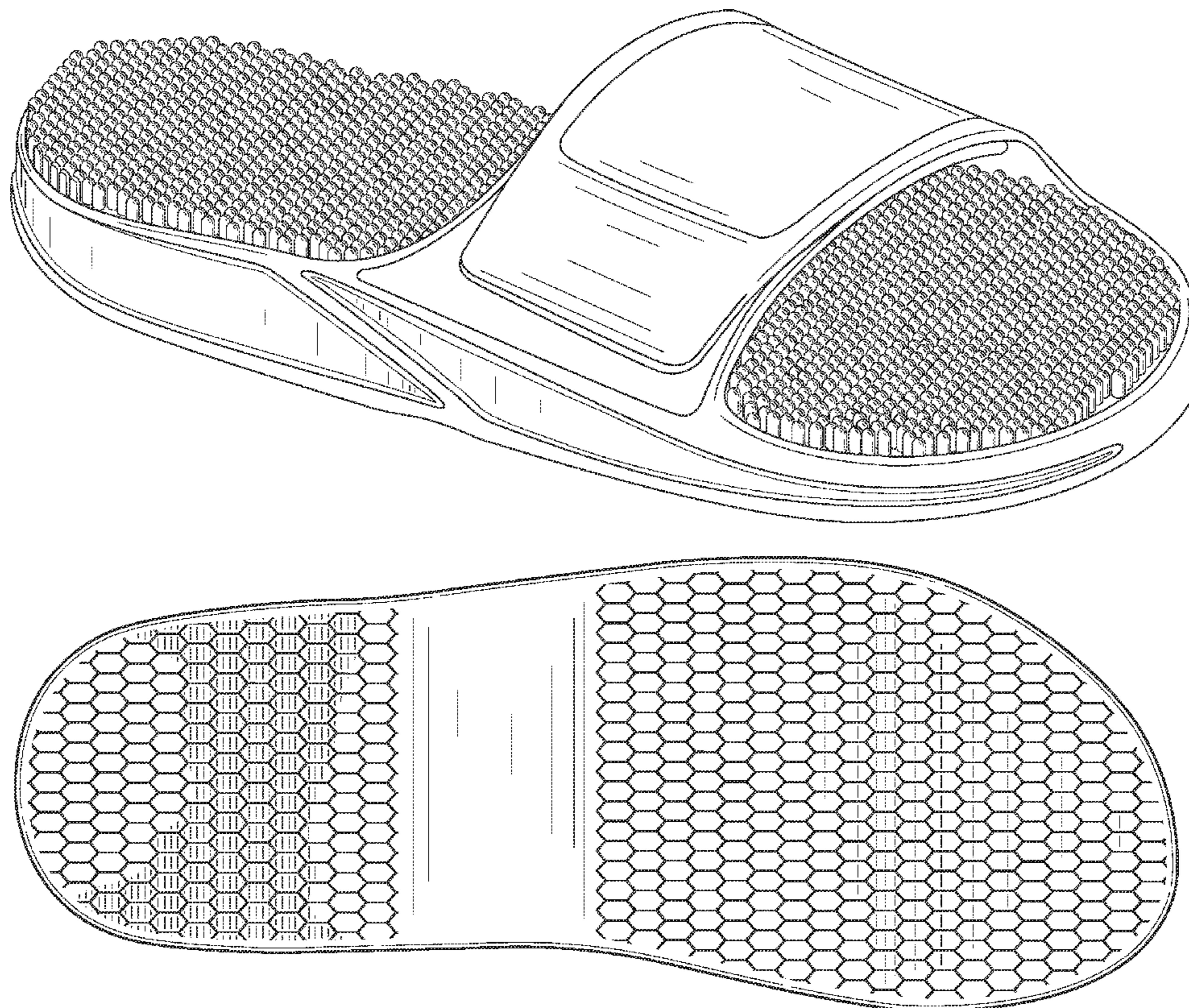

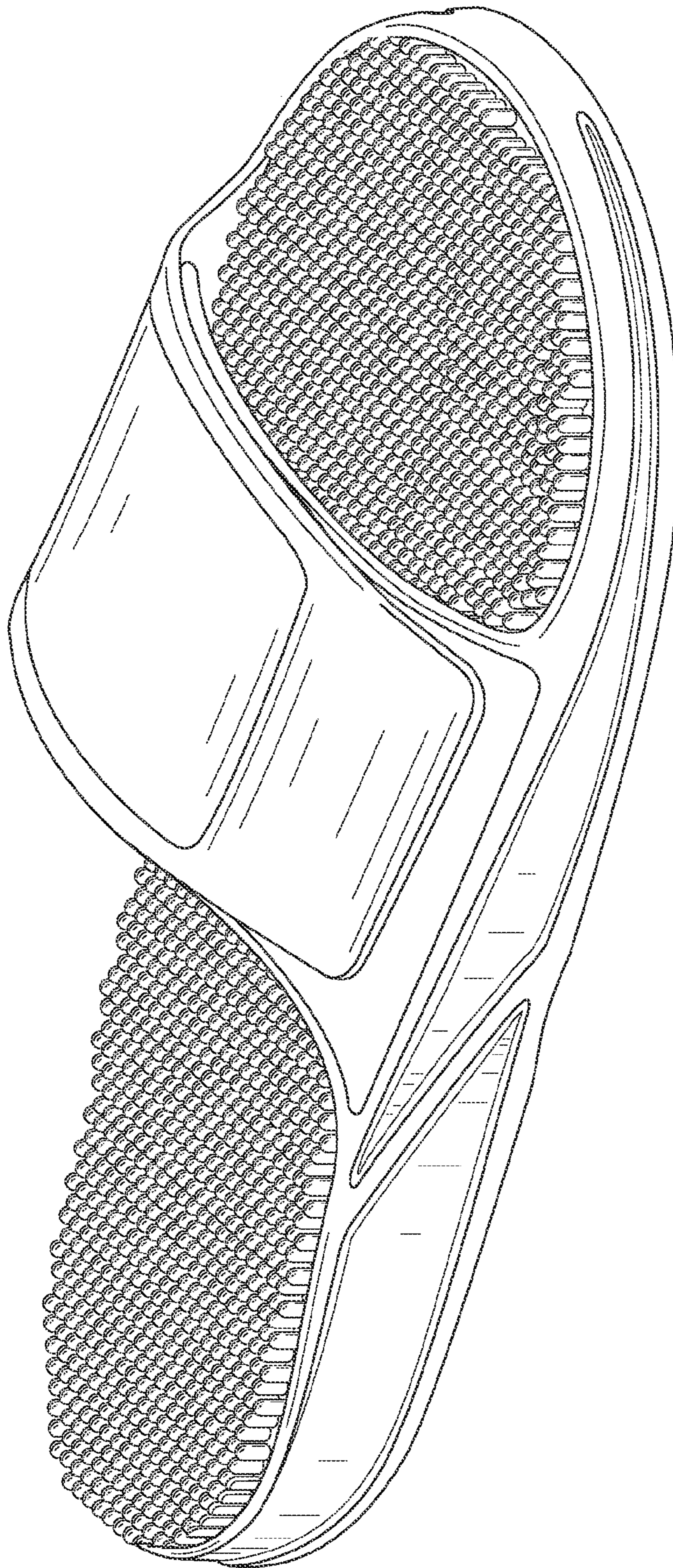

FIG. 1

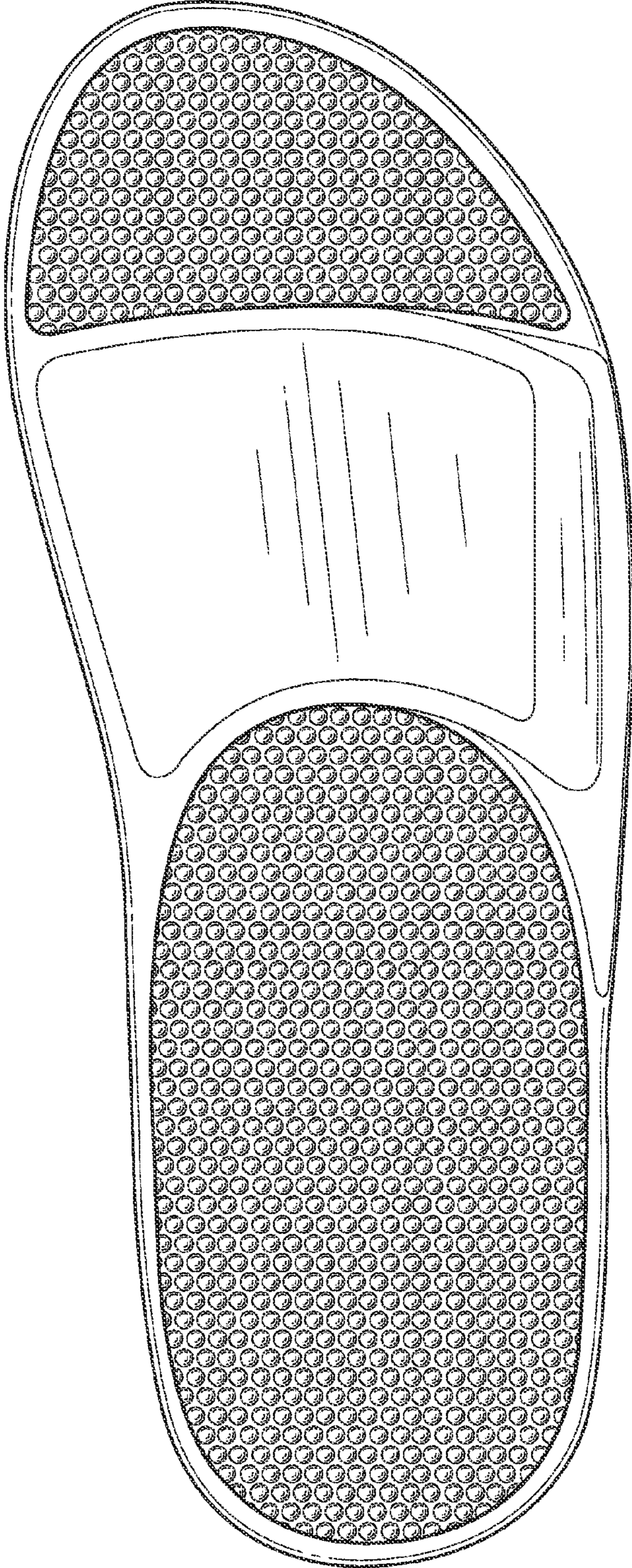

FIG. 2

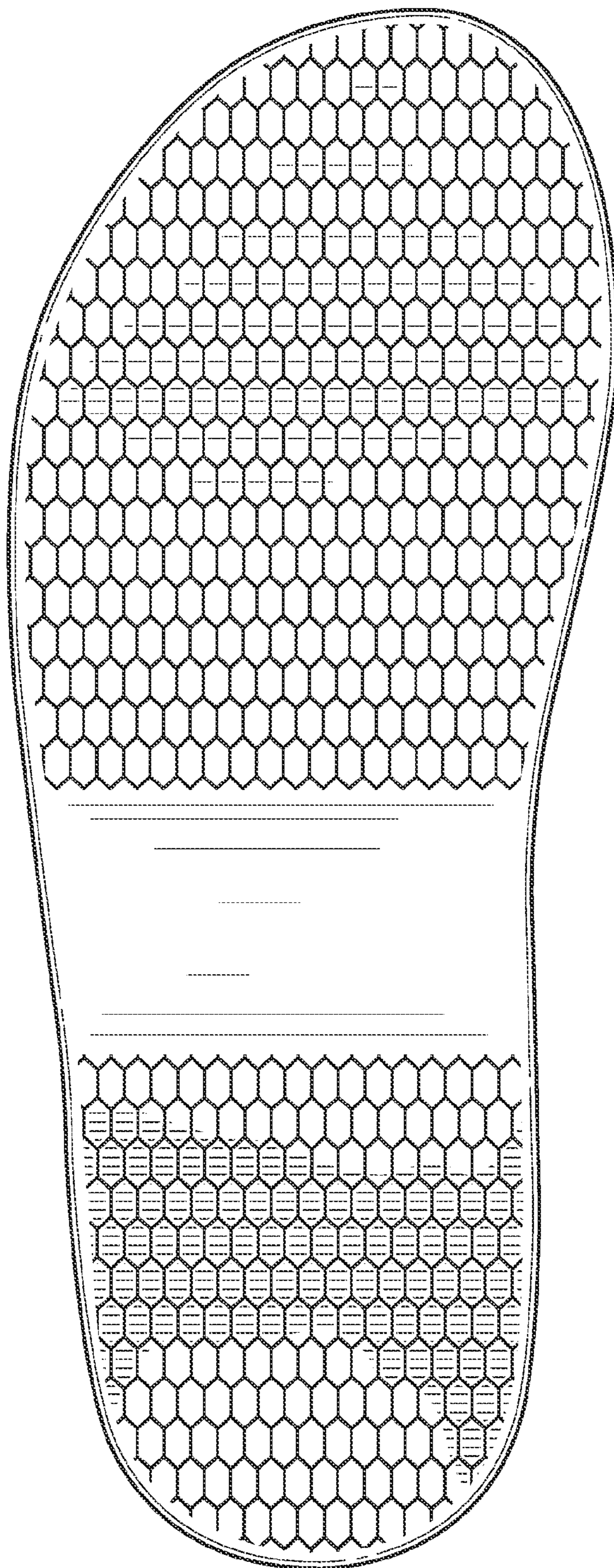

FIG. 3

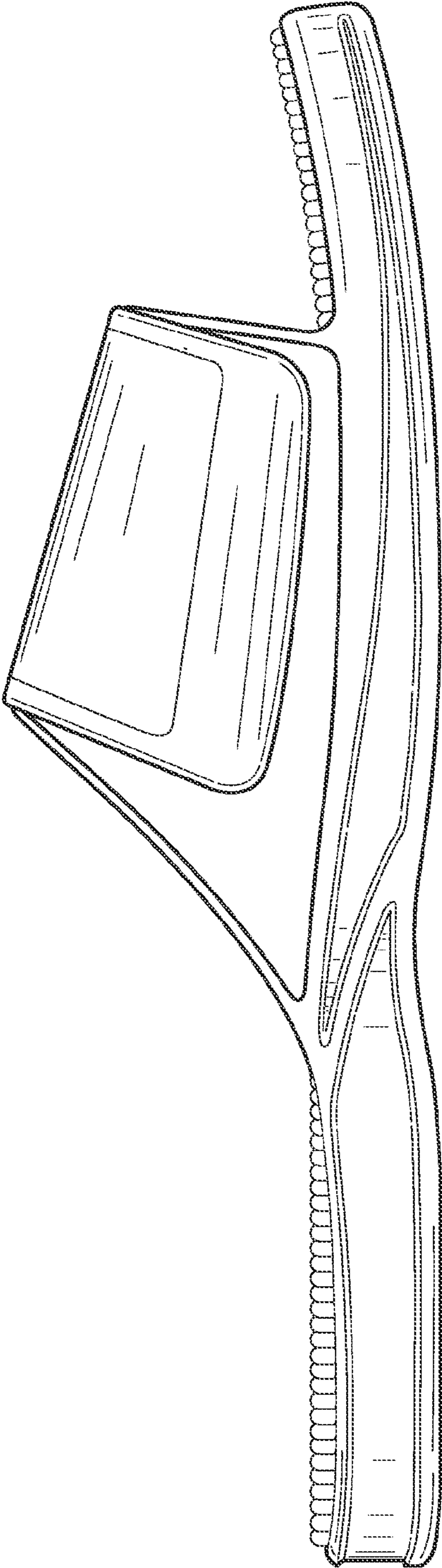

FIG. 4

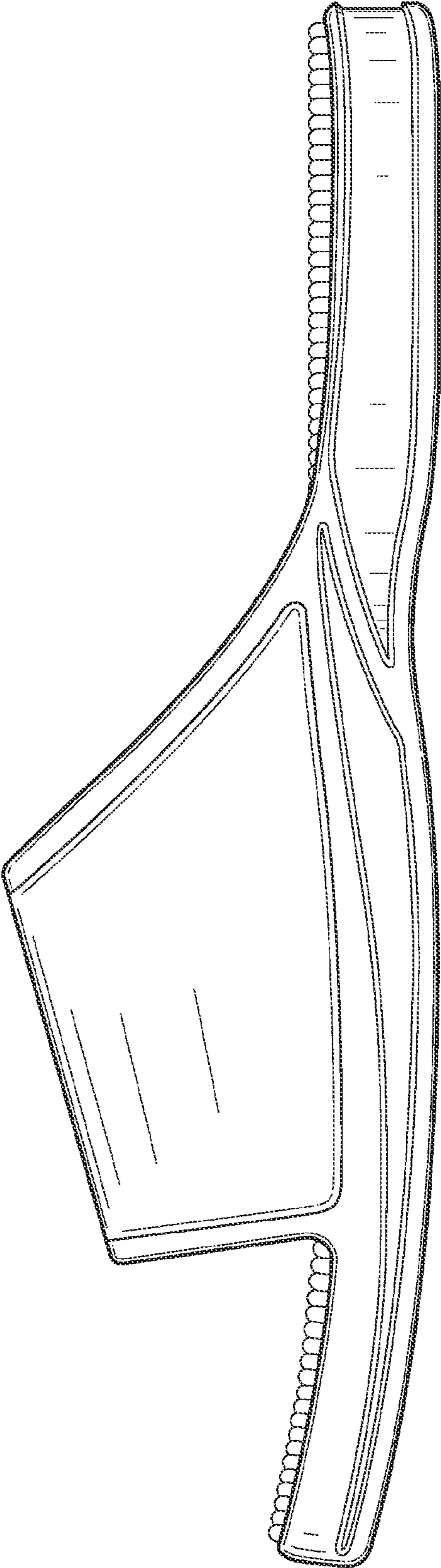

FIG. 5

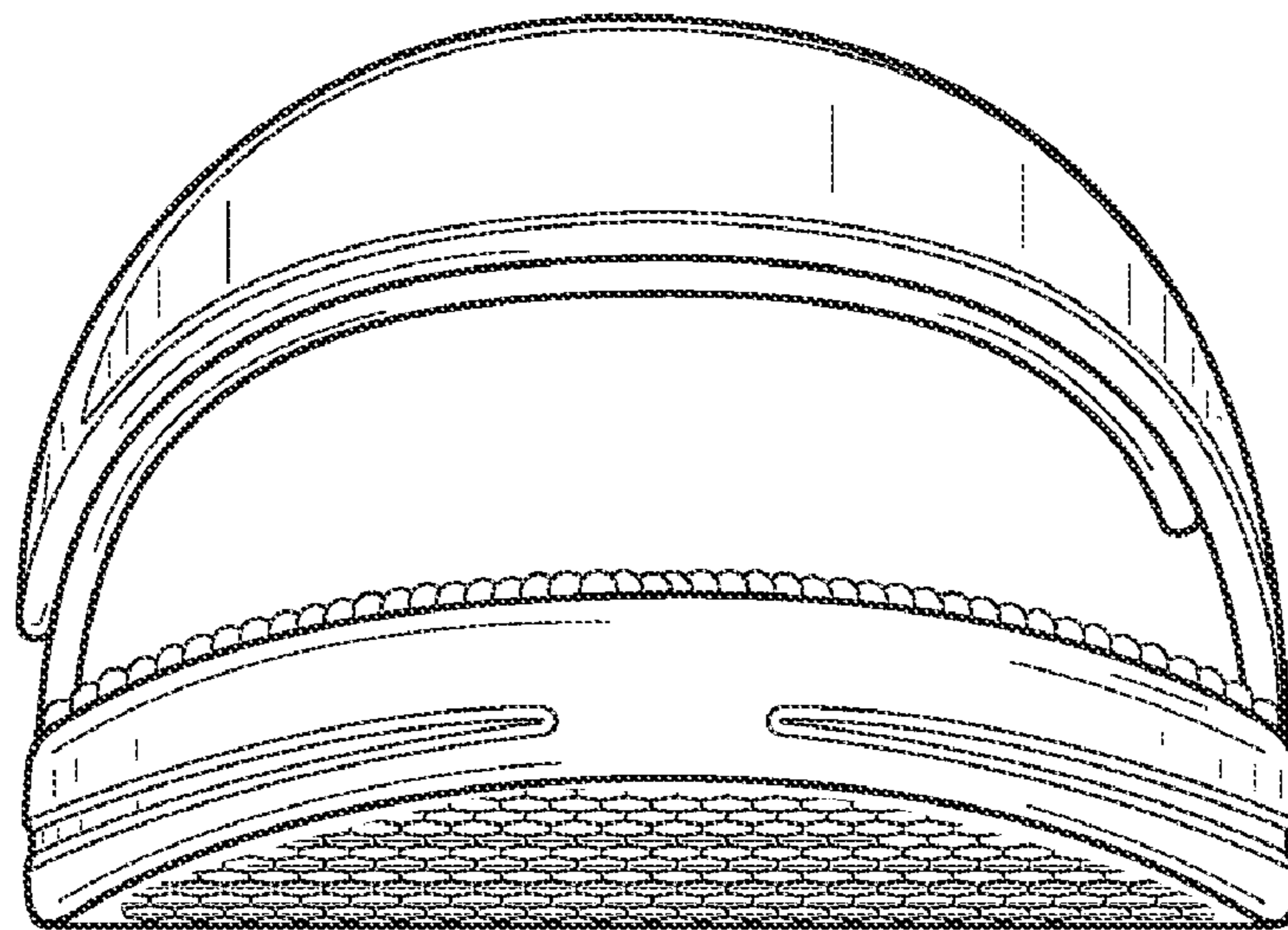

FIG. 6

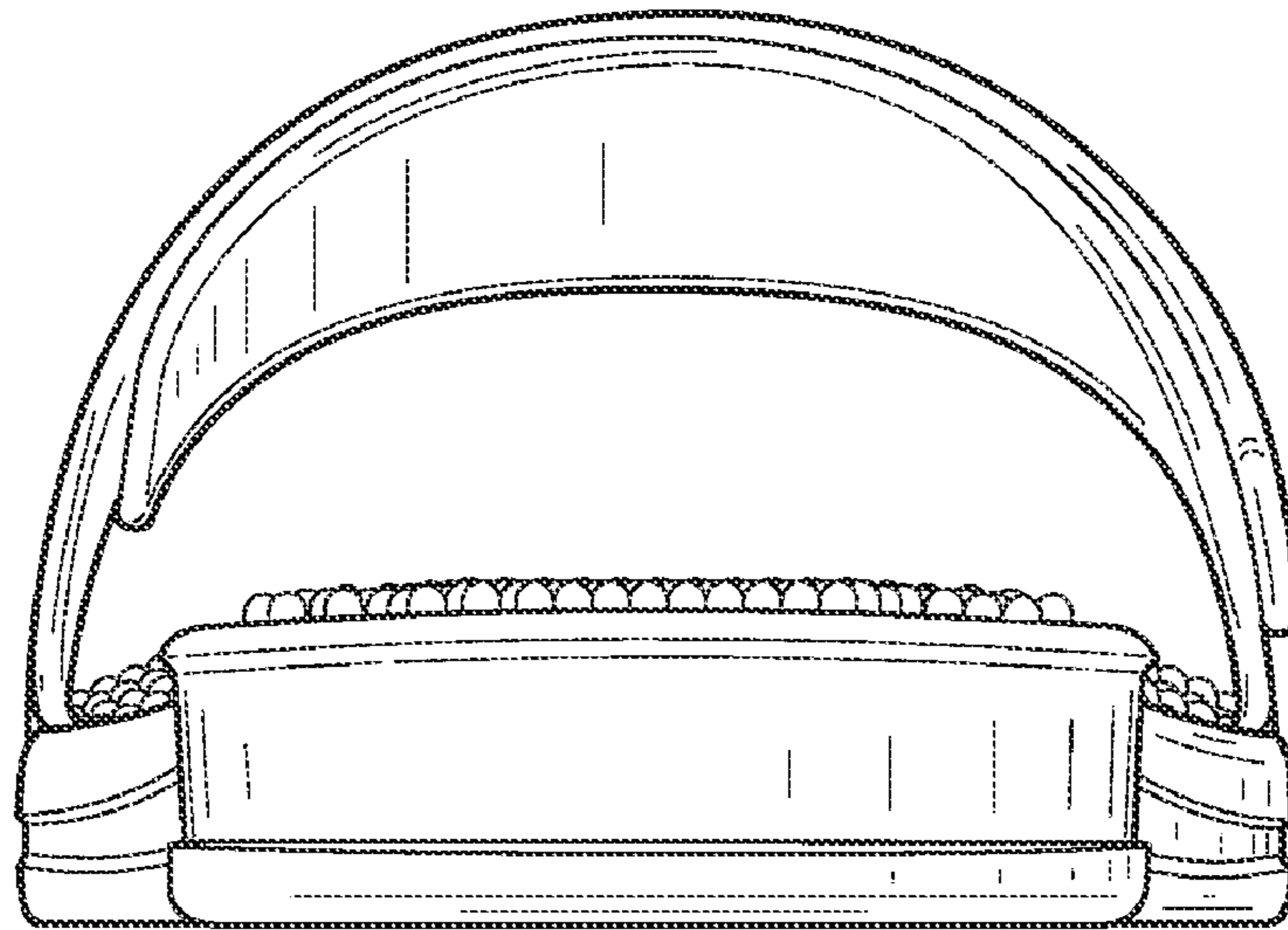

FIG. 7