



US00D614814S

(12) **United States Design Patent**
Lin

(10) **Patent No.:** **US D614,814 S**
(45) **Date of Patent:** **** Apr. 27, 2010**

(54) **COSMETIC CONTAINER**

(75) Inventor: **Shao-Chung Lin**, Taipei Hsien (TW)

(73) Assignee: **Dongguan Mei Guan Cosmetics Co., Ltd.**, Guangdong (CN)

(**) Term: **14 Years**

(21) Appl. No.: **29/334,991**

(22) Filed: **Apr. 7, 2009**

(51) **LOC (9) Cl.** **28-03**

(52) **U.S. Cl.** **D28/83**

(58) **Field of Classification Search** D28/73,
D28/76-78, 83; 220/4.26-4.27; 132/286,
132/287, 293-307, 314-318; 206/581, 823;
D3/205

See application file for complete search history.

(56) **References Cited**

U.S. PATENT DOCUMENTS

4,821,751	A *	4/1989	Chen	132/315
D349,977	S *	8/1994	Shen	D28/78
5,358,100	A *	10/1994	Wolff	132/315
5,878,757	A *	3/1999	Hernandez	132/314
5,941,255	A *	8/1999	Chen	132/315
D479,895	S *	9/2003	Lai	D28/83
D480,180	S *	9/2003	Lai	D28/83

* cited by examiner

Primary Examiner—Jennifer Rivard

(57) **CLAIM**

The ornamental design for a cosmetic container, as shown and described.

DESCRIPTION

FIG. 1 is a front elevational view of a cosmetic container showing my new design;

FIG. 2 is a rear elevational view thereof;

FIG. 3 is a left side view thereof;

FIG. 4 is a right side view thereof;

FIG. 5 is a top plan view thereof;

FIG. 6 is a bottom plan view thereof;

FIG. 7 is a perspective view thereof;

FIG. 8 is a front elevational view of the cosmetic container in an open position;

FIG. 9 is a rear elevational view of the cosmetic container as shown in FIG. 8;

FIG. 10 is a left side view of the cosmetic container as shown in FIG. 8;

FIG. 11 is a right side view of the cosmetic container as shown in FIG. 8;

FIG. 12 is a top plan view of the cosmetic container as shown in FIG. 8;

FIG. 13 is a bottom plan view of the cosmetic container as shown in FIG. 8;

FIG. 14 is a perspective view of the cosmetic container as shown in FIG. 8;

FIG. 15 is another perspective view of the cosmetic container as shown in FIG. 8;

FIG. 16 is another perspective view of the cosmetic container as shown in FIG. 8;

FIG. 17 is a perspective view of the cosmetic container in an open position with some parts detached from the container;

FIG. 18 is a bottom perspective view of the cosmetic container as shown in FIG. 8;

FIG. 19 is a perspective view of a compact removed from the cosmetic container; and,

FIG. 20 is another perspective view of the compact as shown in FIG. 19.

The compact is shown separately for convenience of illustration.

1 Claim, 10 Drawing Sheets

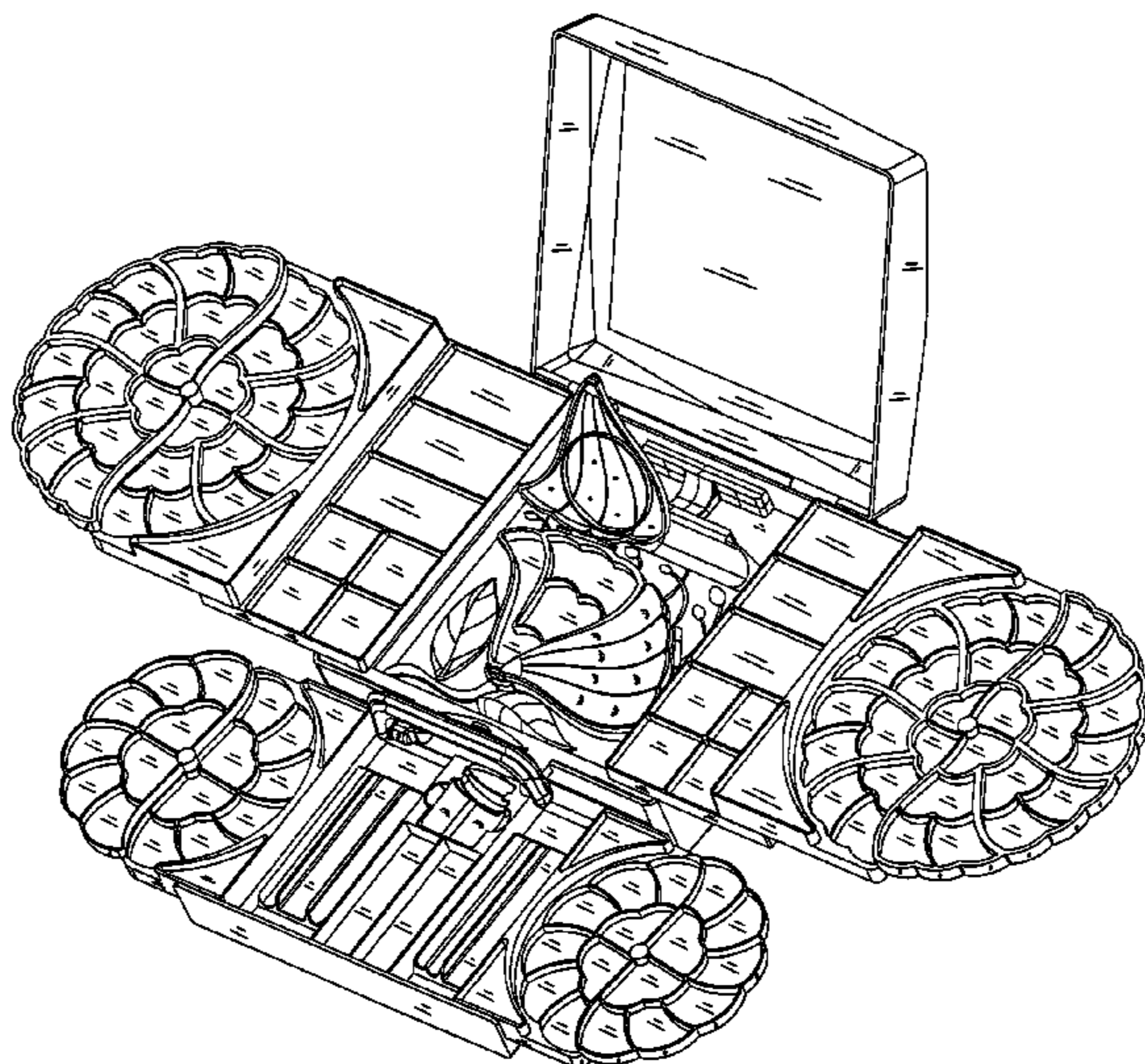

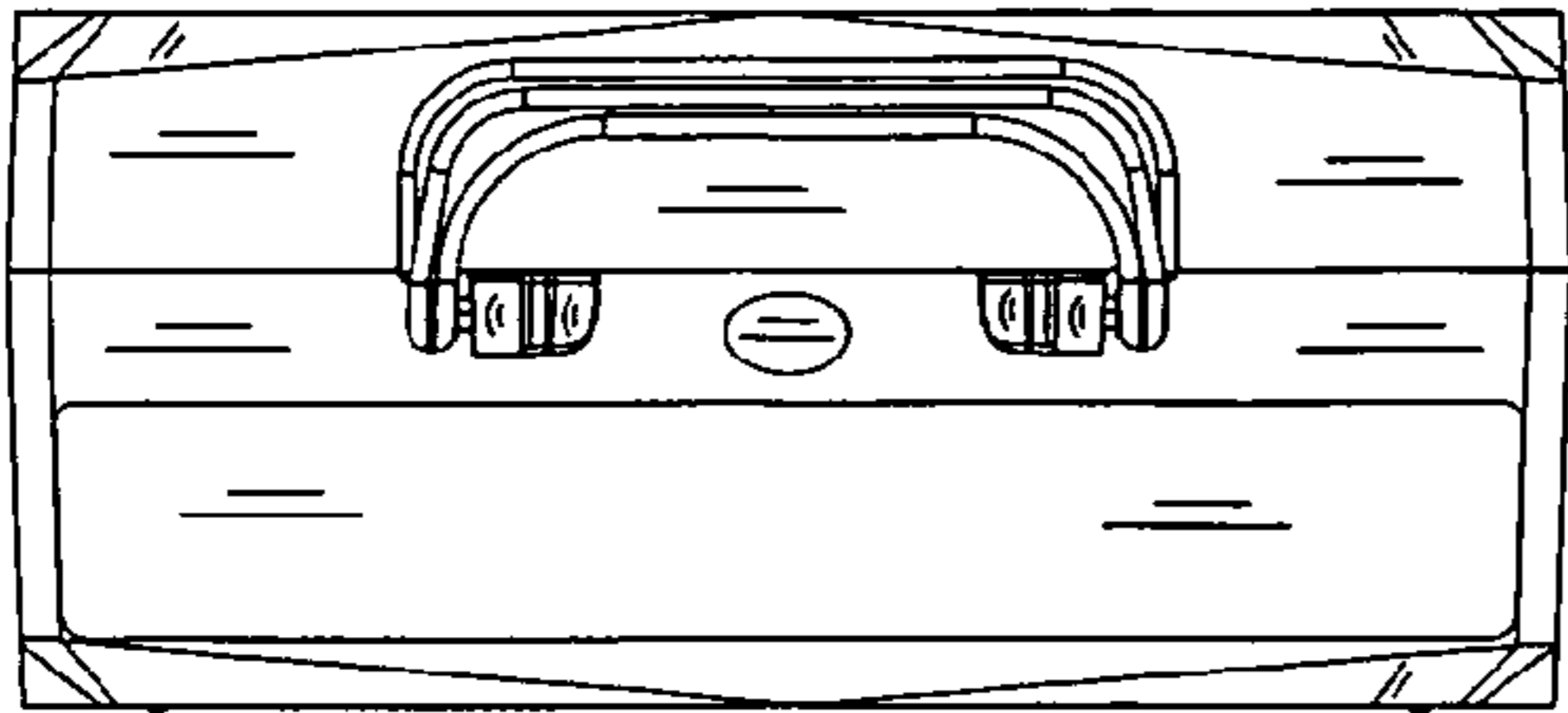

FIG. 1

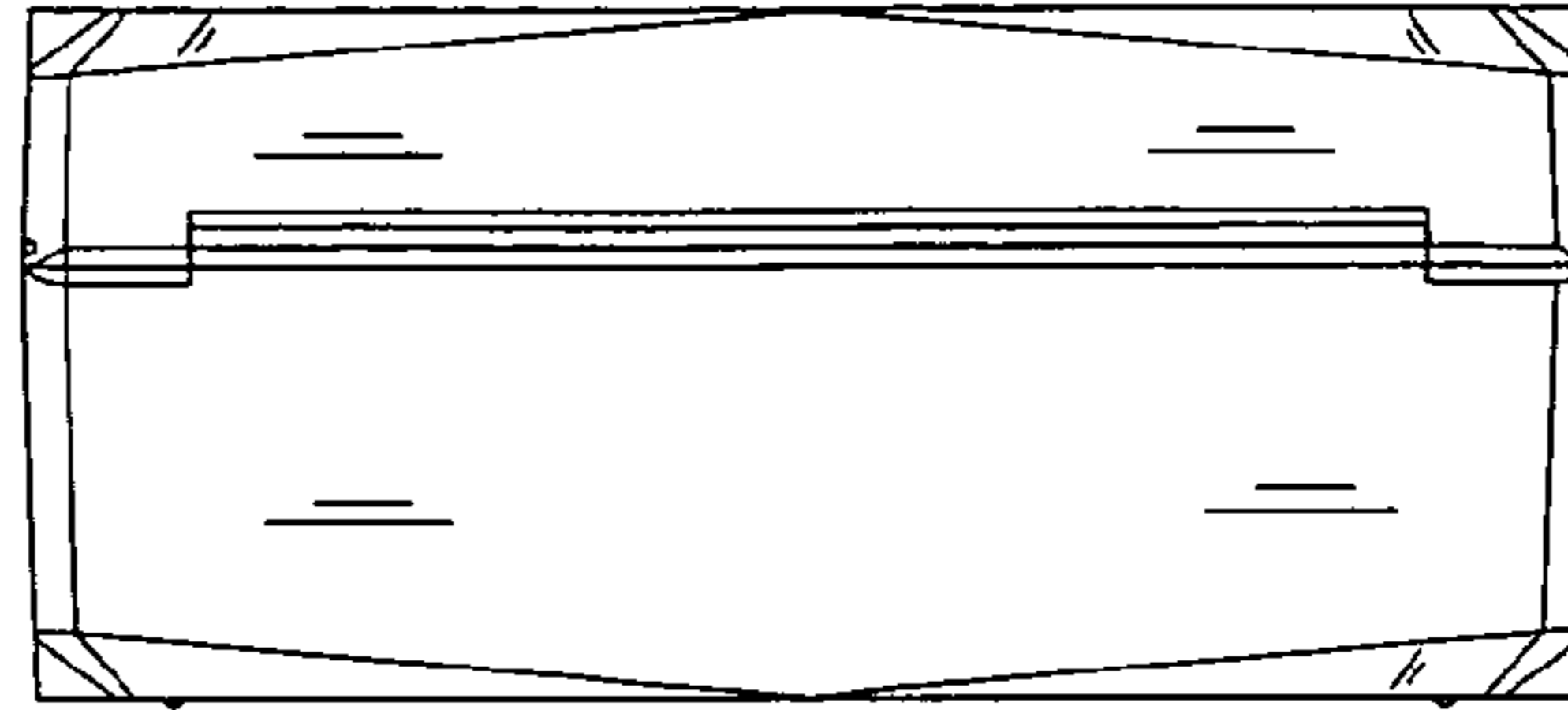

FIG. 2

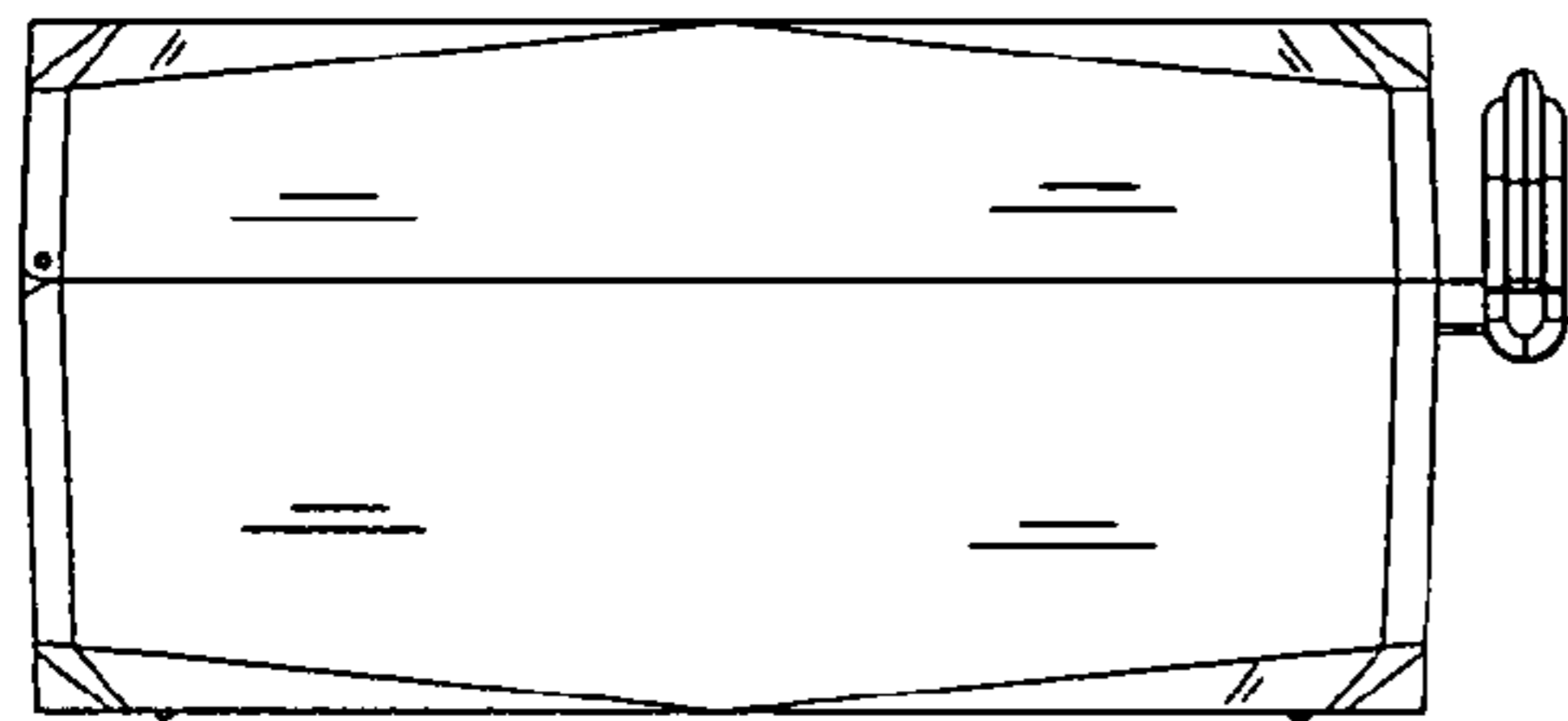

FIG. 3

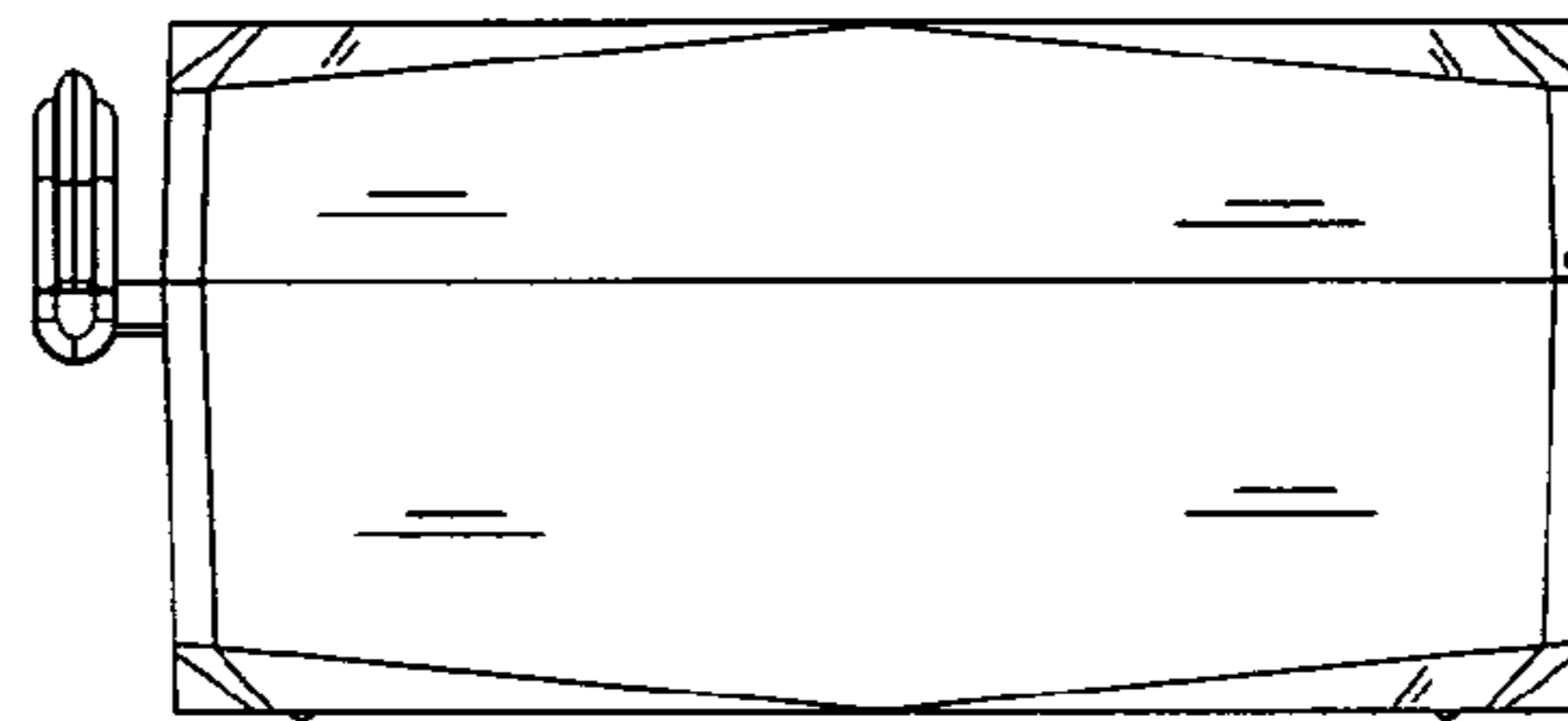

FIG. 4

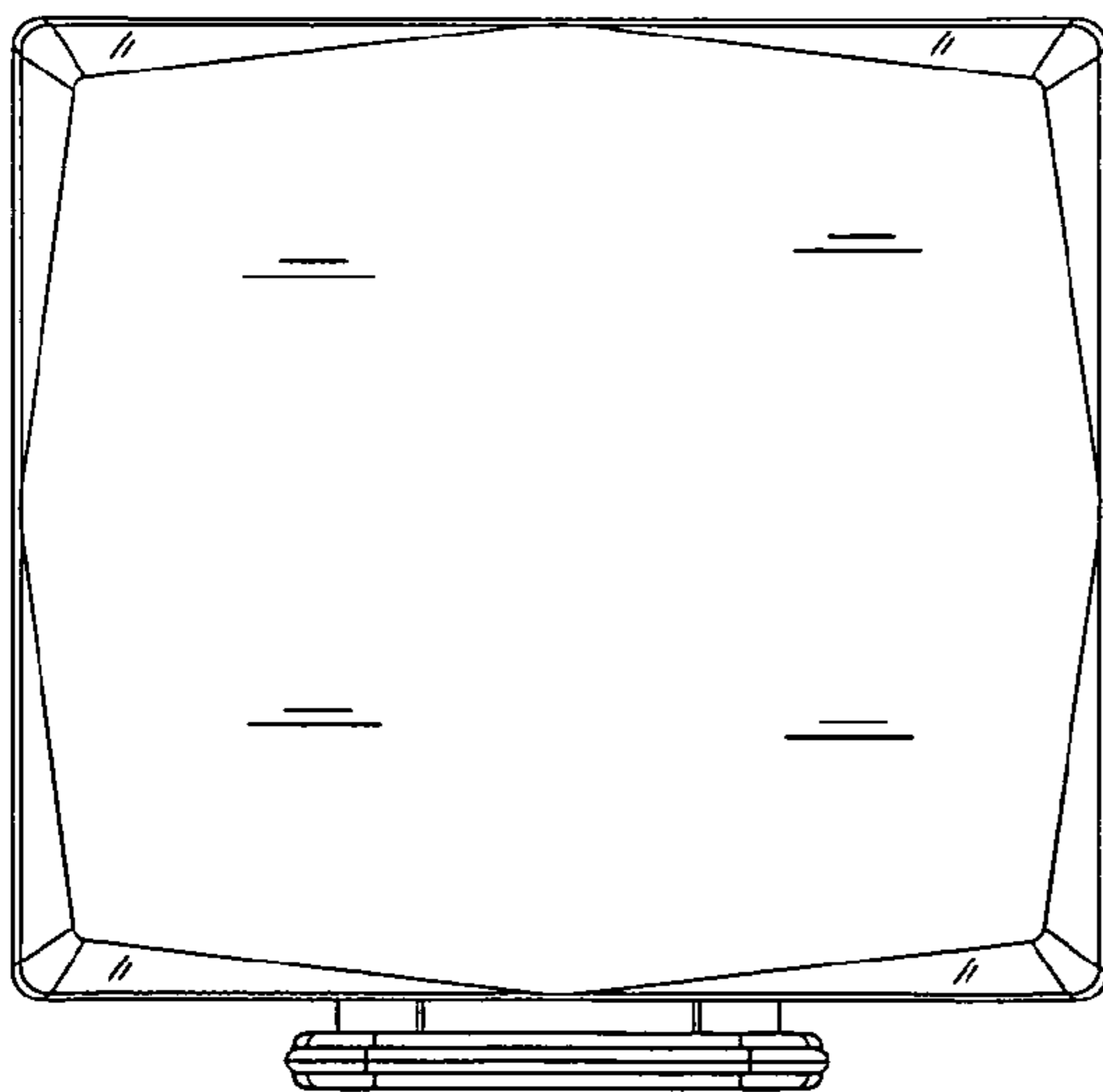

FIG. 5

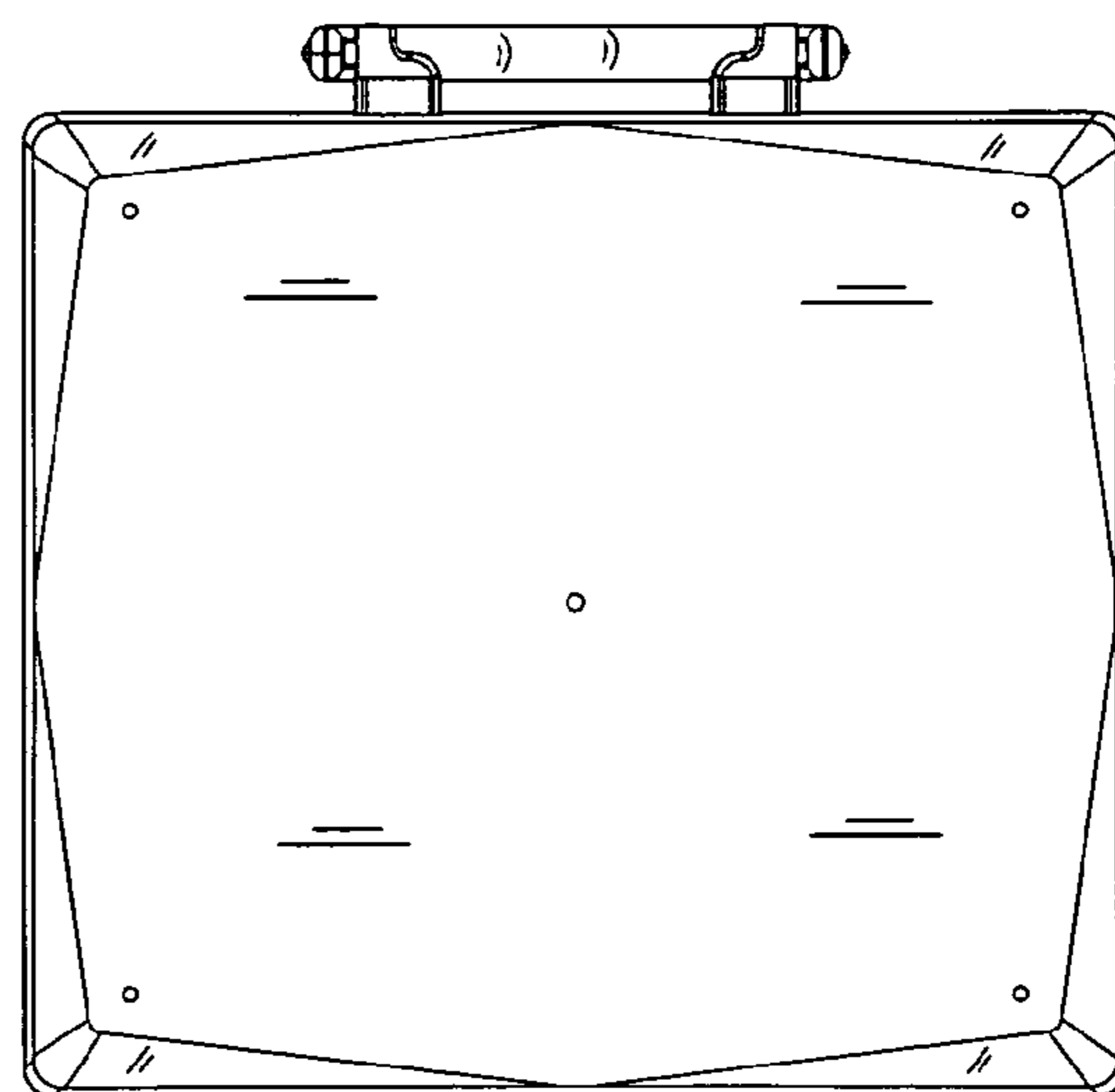

FIG. 6

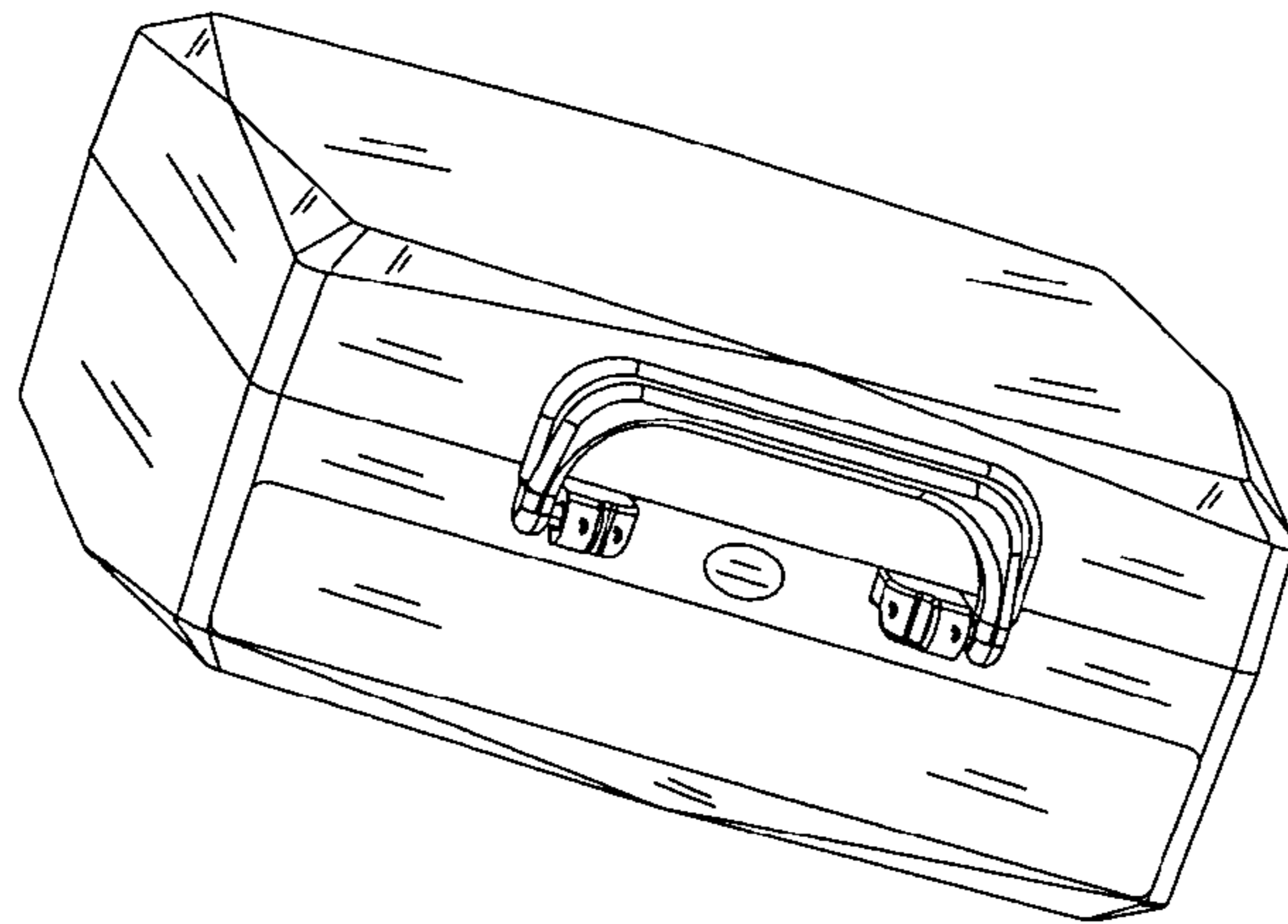

FIG. 7

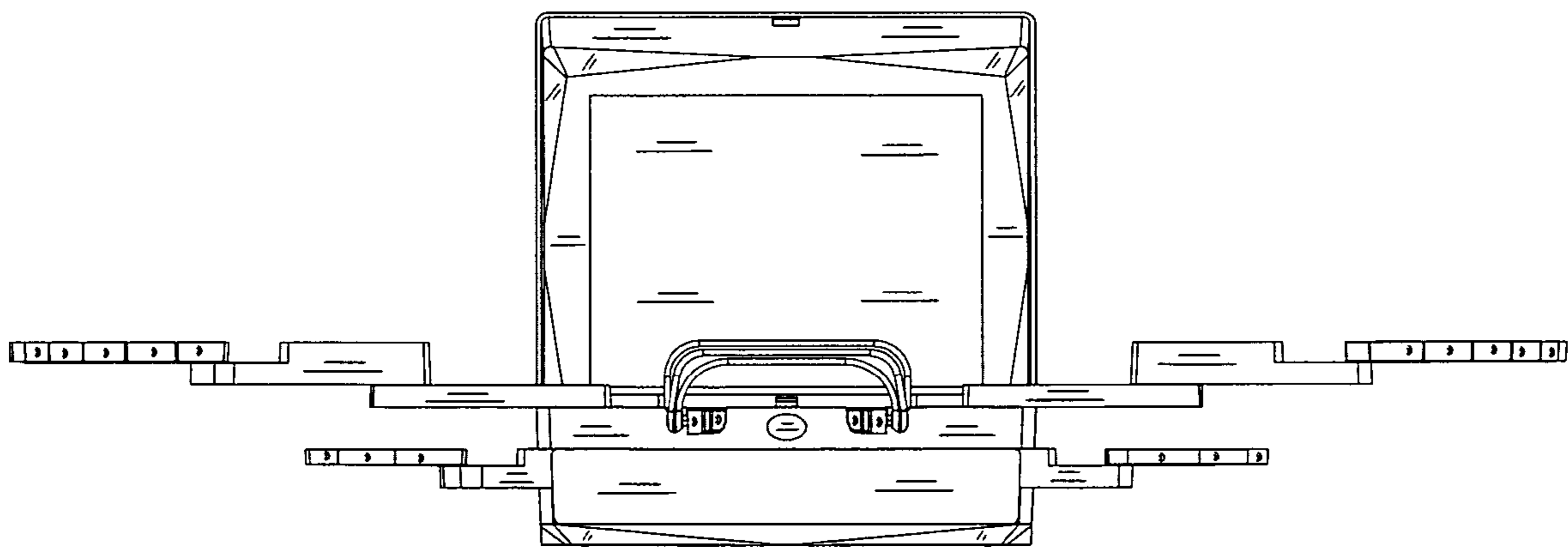

FIG. 8

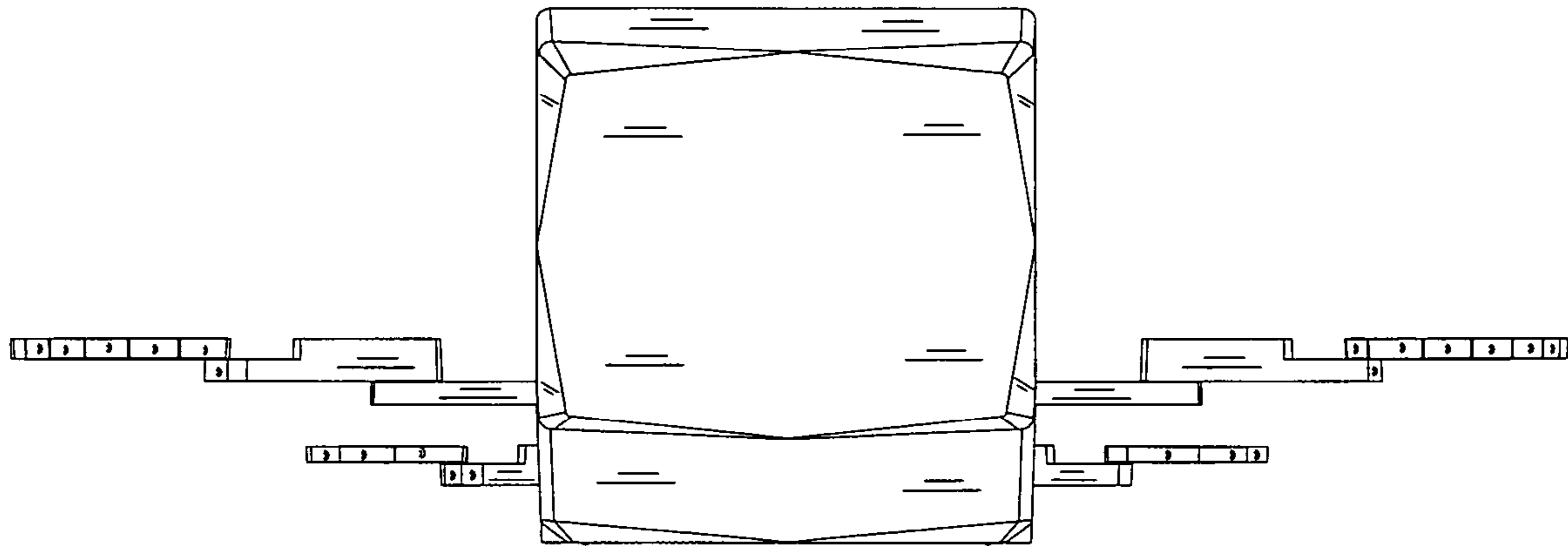

FIG. 9

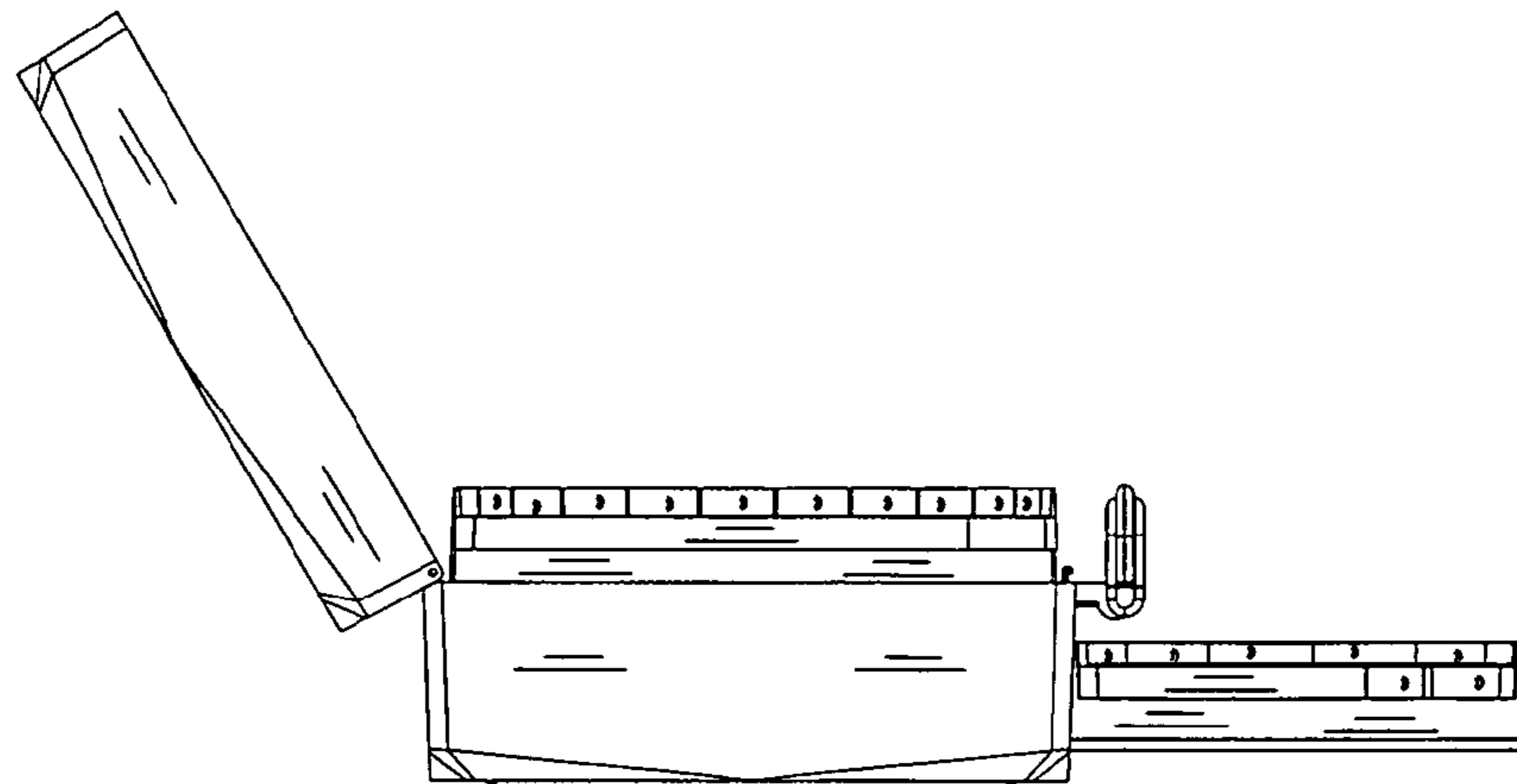

FIG. 10

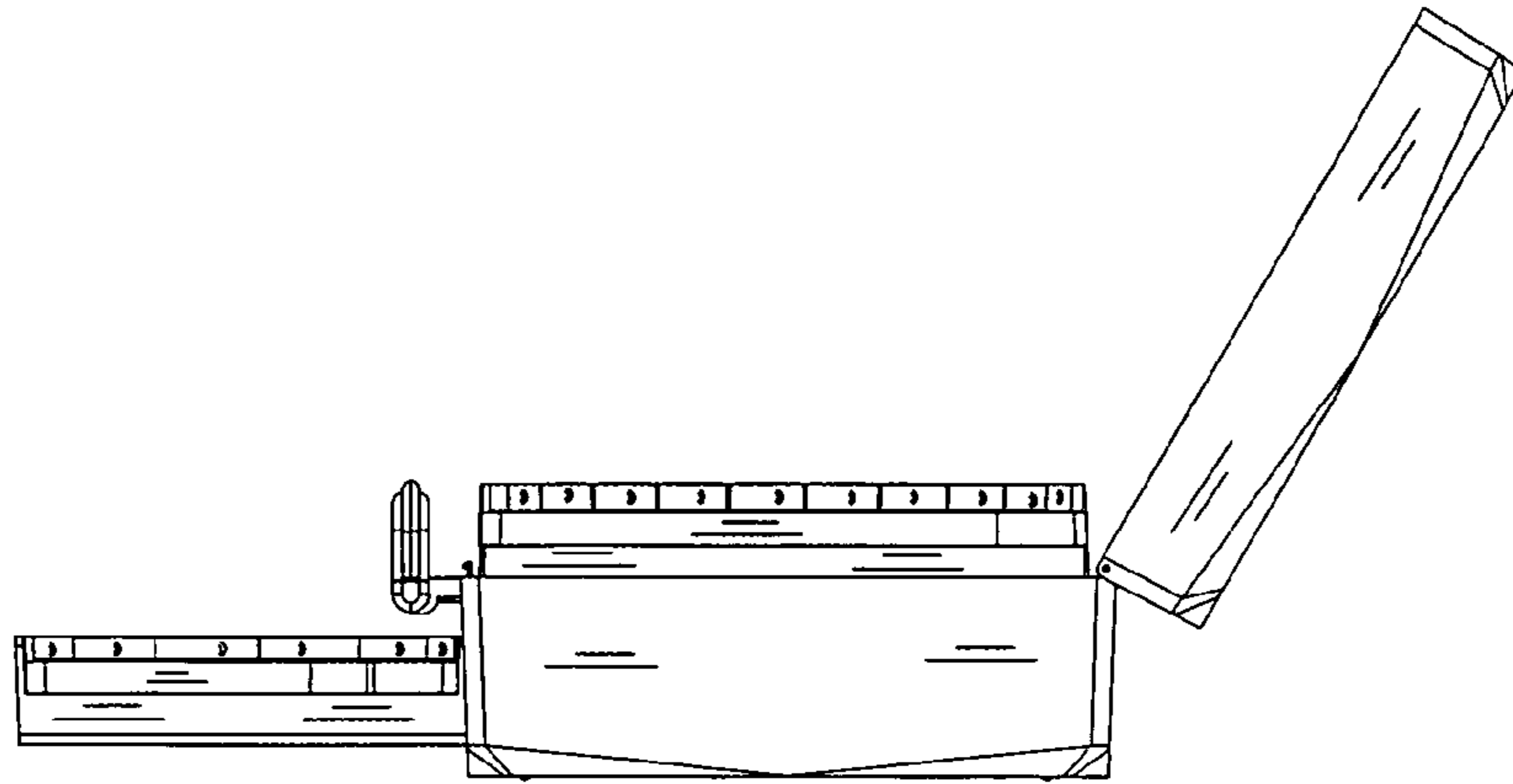

FIG. 11

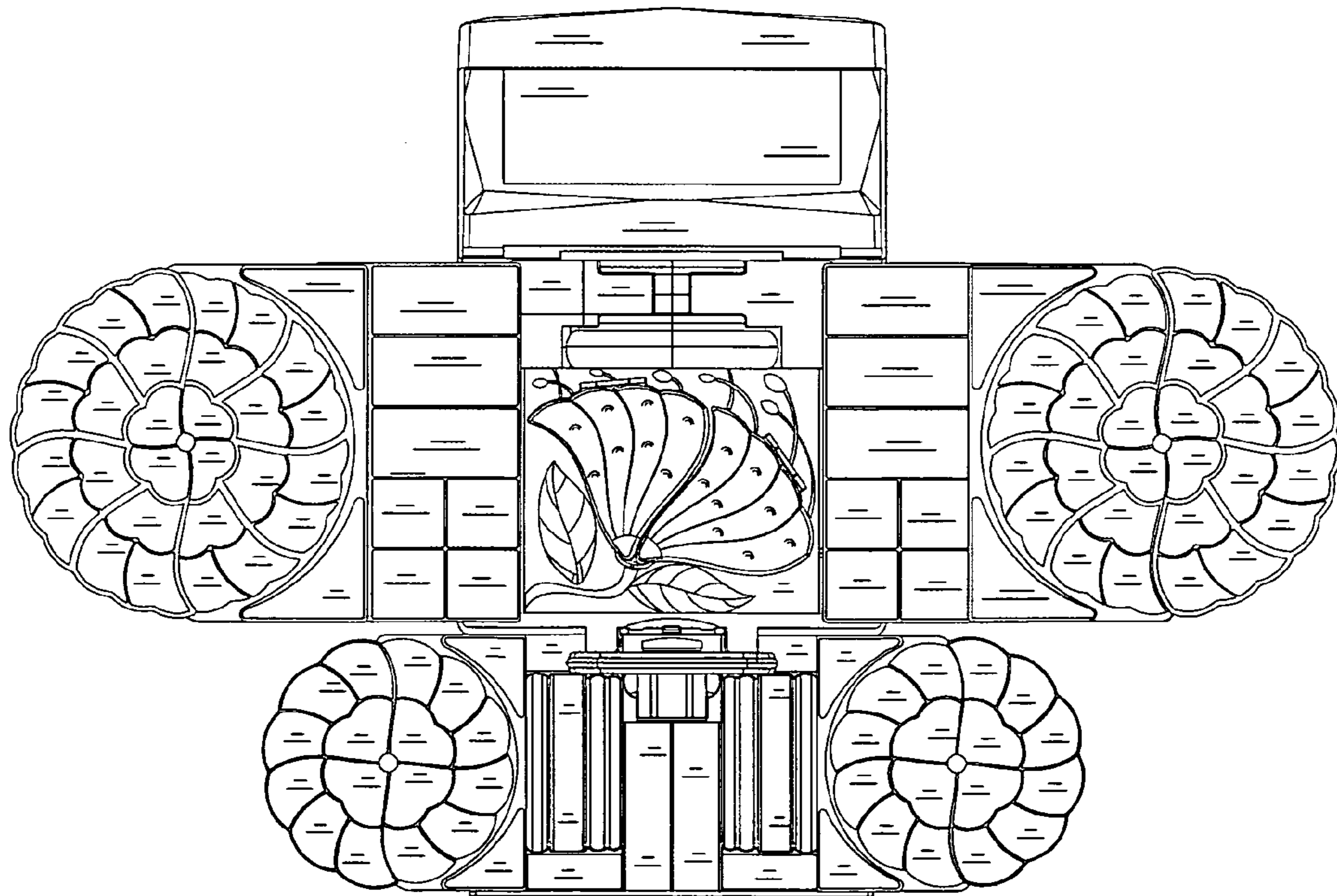

FIG. 12

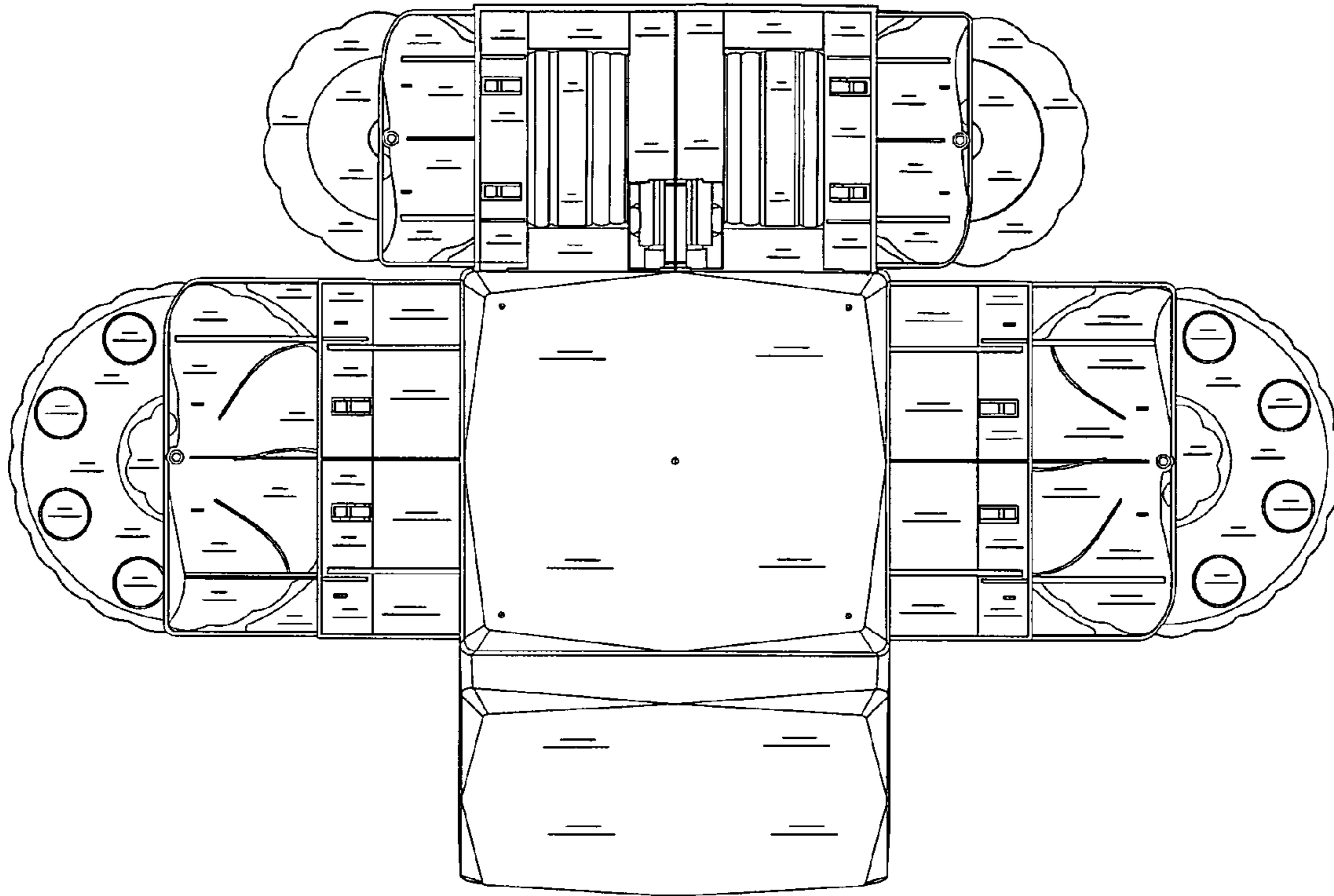

FIG. 13

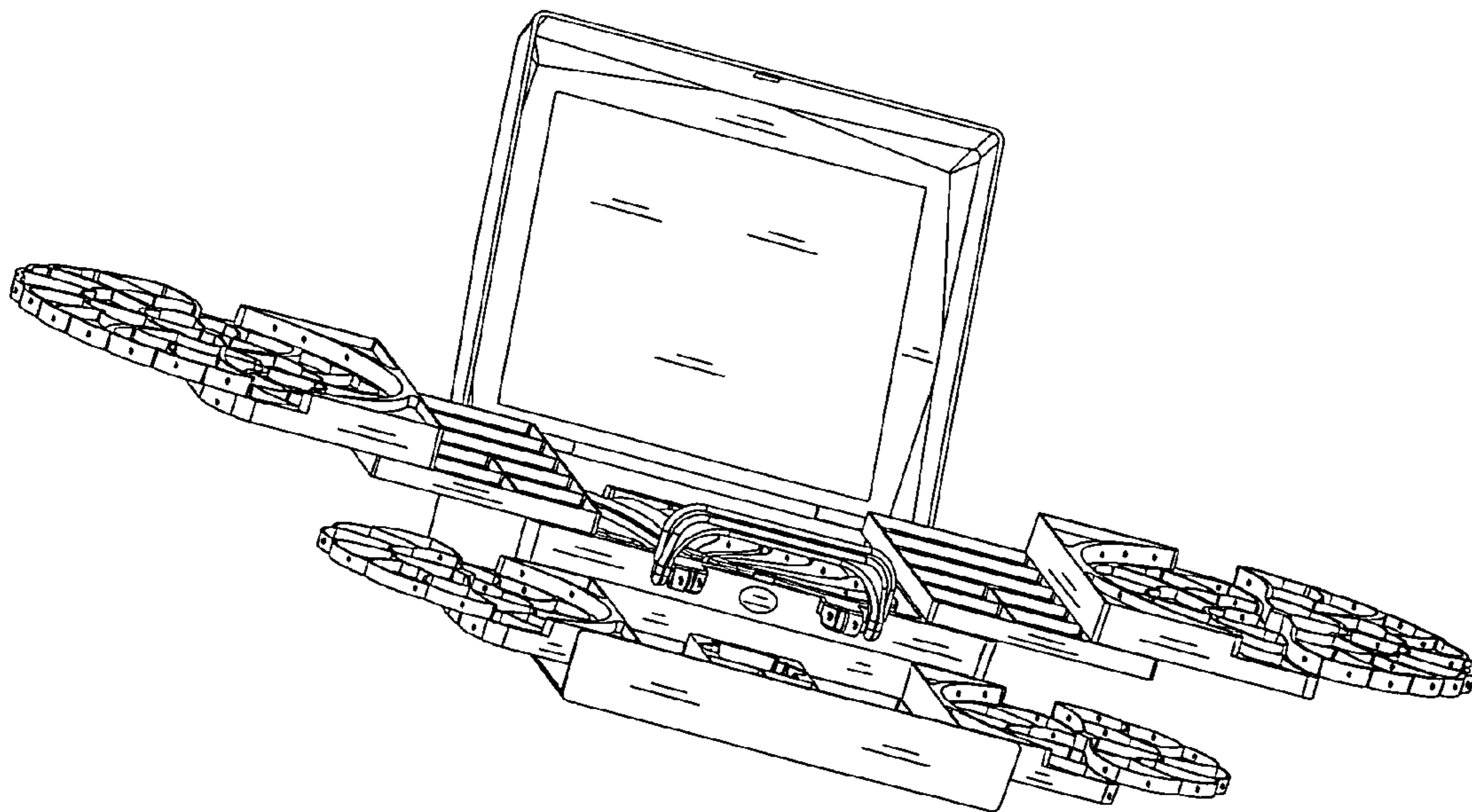

FIG. 14

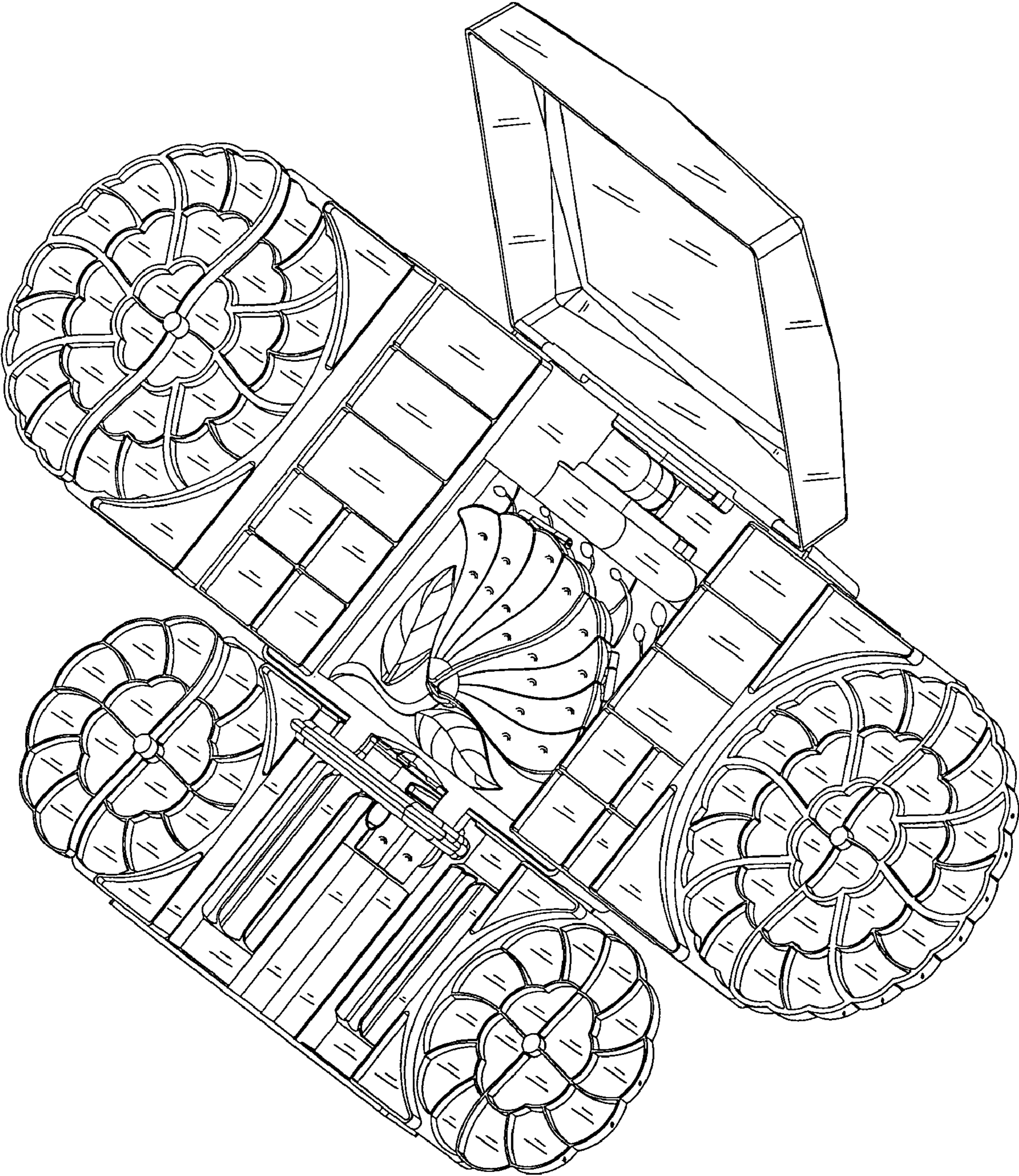

FIG. 15

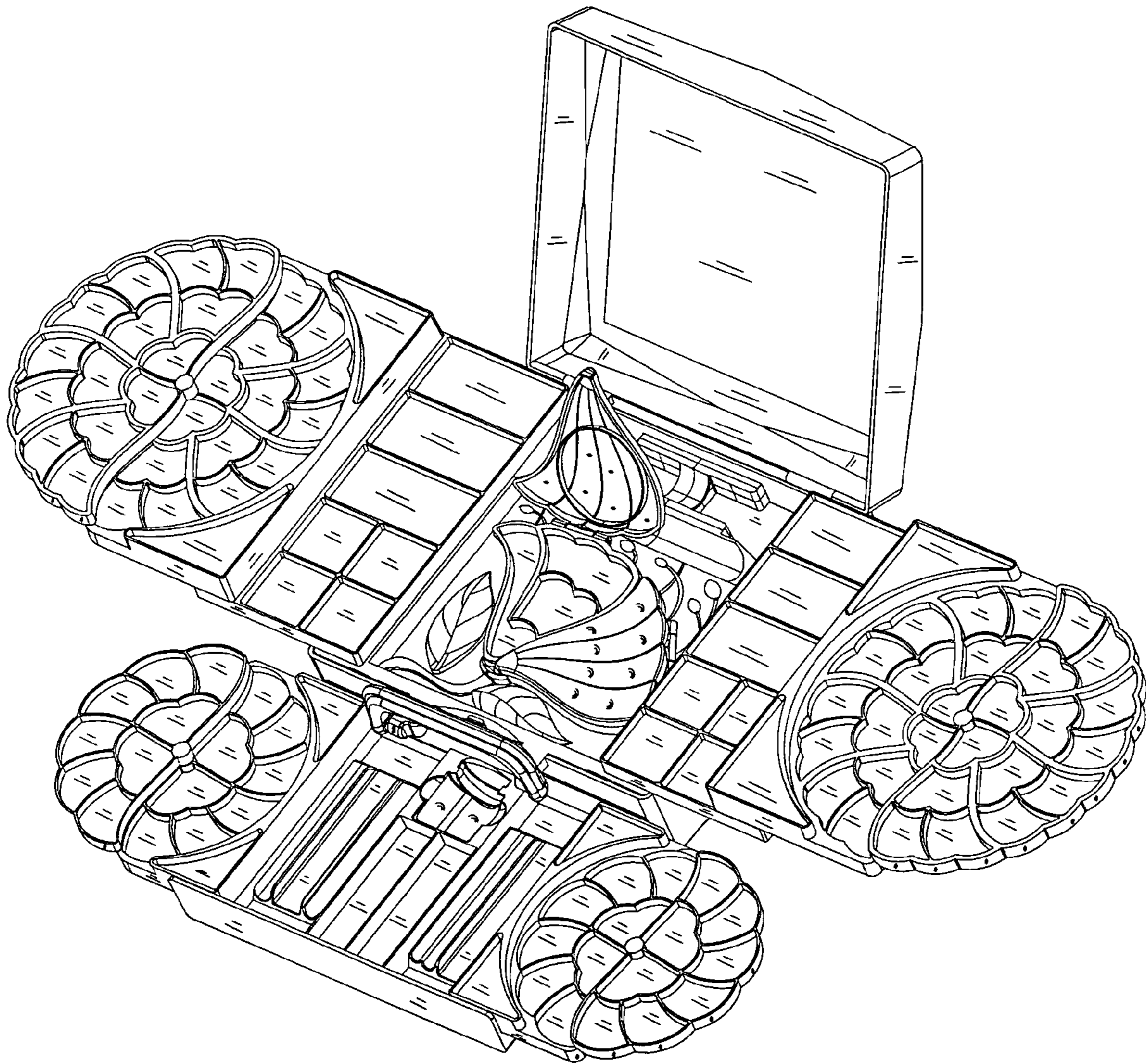

FIG. 16

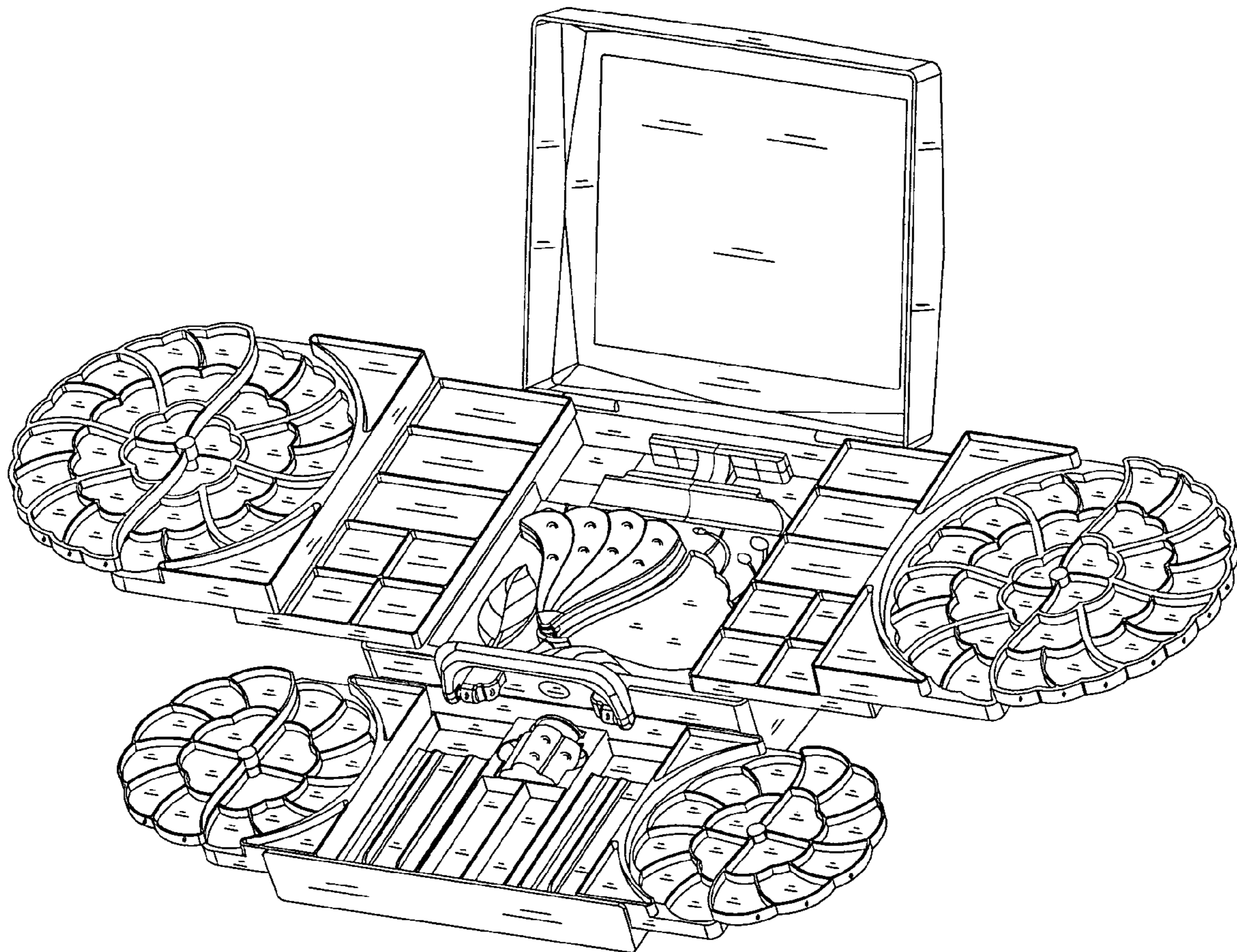

FIG. 17

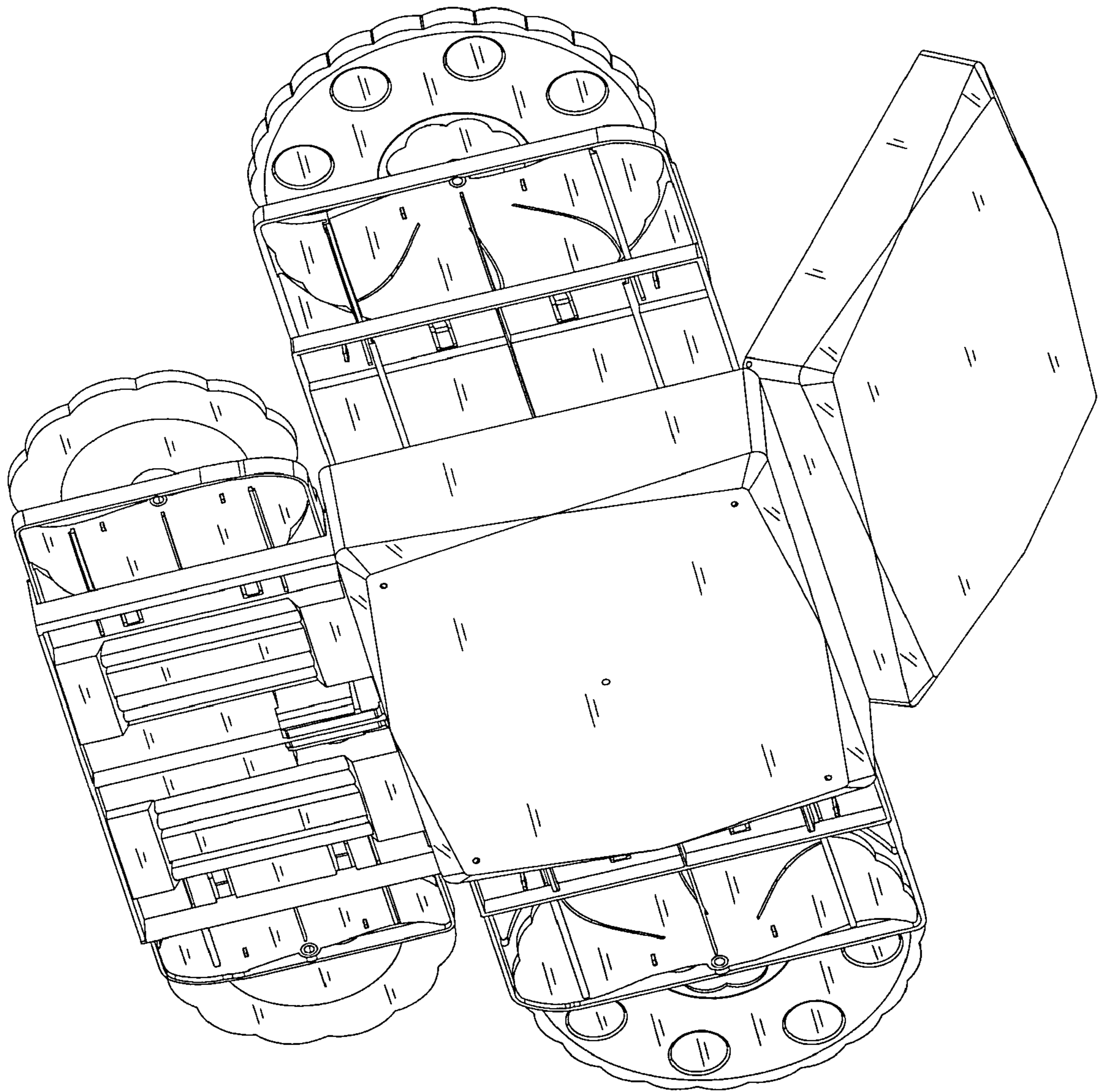

FIG. 18

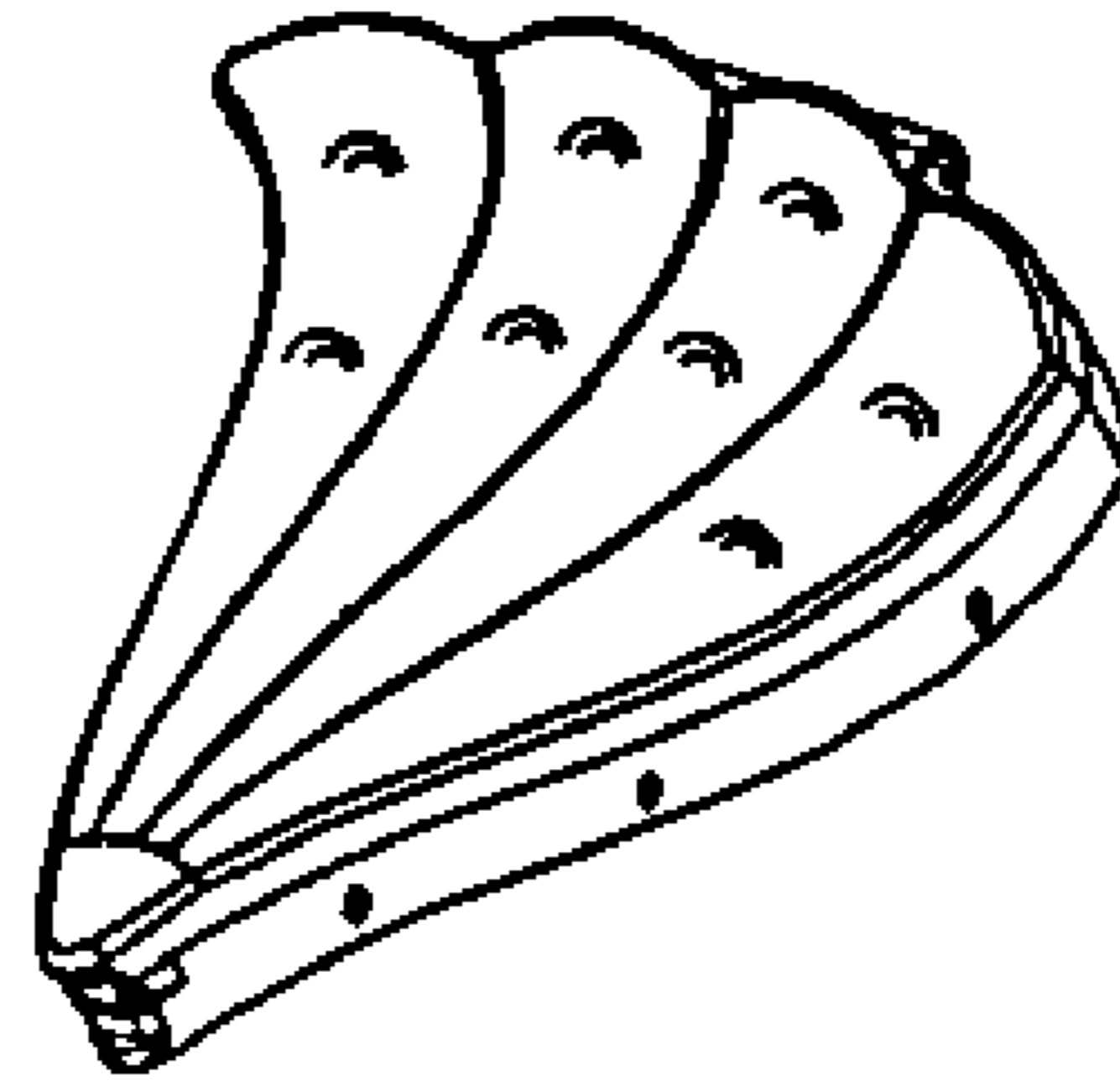

FIG. 19

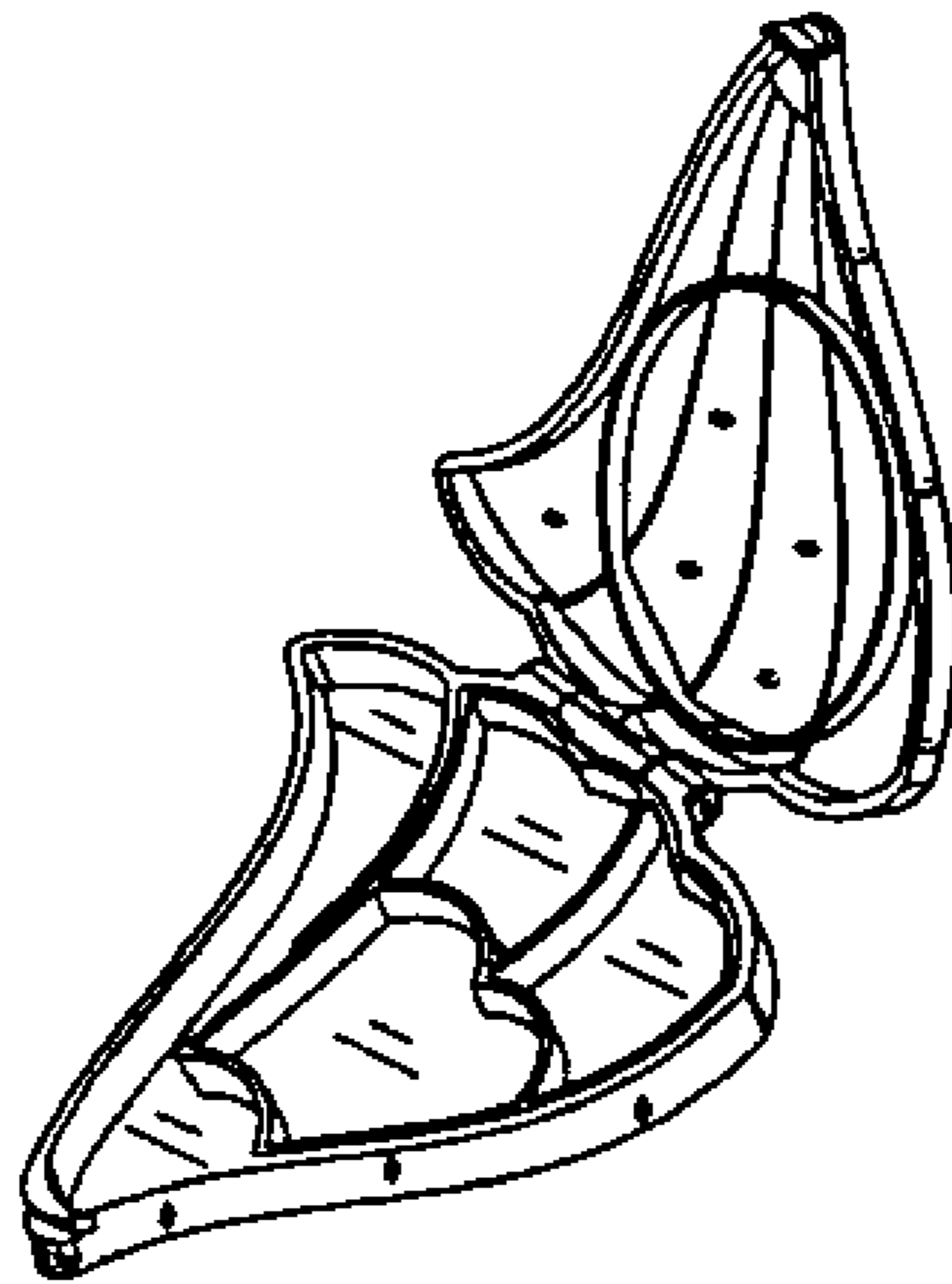

FIG. 20