



US00D614684S

(12) **United States Design Patent**
Inoue et al.

(10) **Patent No.:** **US D614,684 S**
(45) **Date of Patent:** **** Apr. 27, 2010**

(54) **PROJECTOR**

(75) Inventors: **Saeko Inoue**, Matsumoto (JP); **Isao Sakamaki**, Matsumoto (JP); **Genta Kawabe**, Matsumoto (JP); **Kunihisa Nakamura**, Iida (JP); **Hideki Takasuka**, Matsumoto (JP)

(73) Assignee: **Seiko Epson Corporation**, Tokyo (JP)

(**) Term: **14 Years**

(21) Appl. No.: **29/338,047**

(22) Filed: **Jun. 3, 2009**

(30) **Foreign Application Priority Data**

Jan. 28, 2009 (JP) 2009-001593

(51) **LOC (9) Cl.** **16-02**

(52) **U.S. Cl.** **D16/230; D16/225**

(58) **Field of Classification Search** D16/205,
D16/208, 221, 225, 230-231, 234; D21/514;
353/115, 119, 122

See application file for complete search history.

(56) **References Cited**

U.S. PATENT DOCUMENTS

D470,525 S * 2/2003 Nakayama et al. D16/231
D474,799 S * 5/2003 Kawasaki et al. D16/230
D475,729 S * 6/2003 Shiota et al. D16/230

6,793,346 B2 * 9/2004 Nakano et al. 353/119
D504,453 S * 4/2005 Junsu et al. D16/231
7,156,526 B2 * 1/2007 Tanaka 353/119
D574,875 S * 8/2008 Sakamaki et al. D16/230
D591,784 S 5/2009 Inoue et al.
D597,581 S * 8/2009 Sakamaki et al. D16/230

* cited by examiner

Primary Examiner—Ian Simmons

Assistant Examiner—Wan Laymon

(74) *Attorney, Agent, or Firm*—Oliff & Berridge, PLC

(57) **CLAIM**

The ornamental design for a projector, as shown and described.

DESCRIPTION

FIG. 1 is a front perspective view of a projector;
FIG. 2 is a front view thereof;
FIG. 3 is a rear view thereof;
FIG. 4 is a left-side view thereof;
FIG. 5 is a right-side view thereof;
FIG. 6 is a top view thereof;
FIG. 7 is a bottom view thereof; and,
FIG. 8 is another front perspective view thereof showing a lens cover in a closed position.

1 Claim, 6 Drawing Sheets

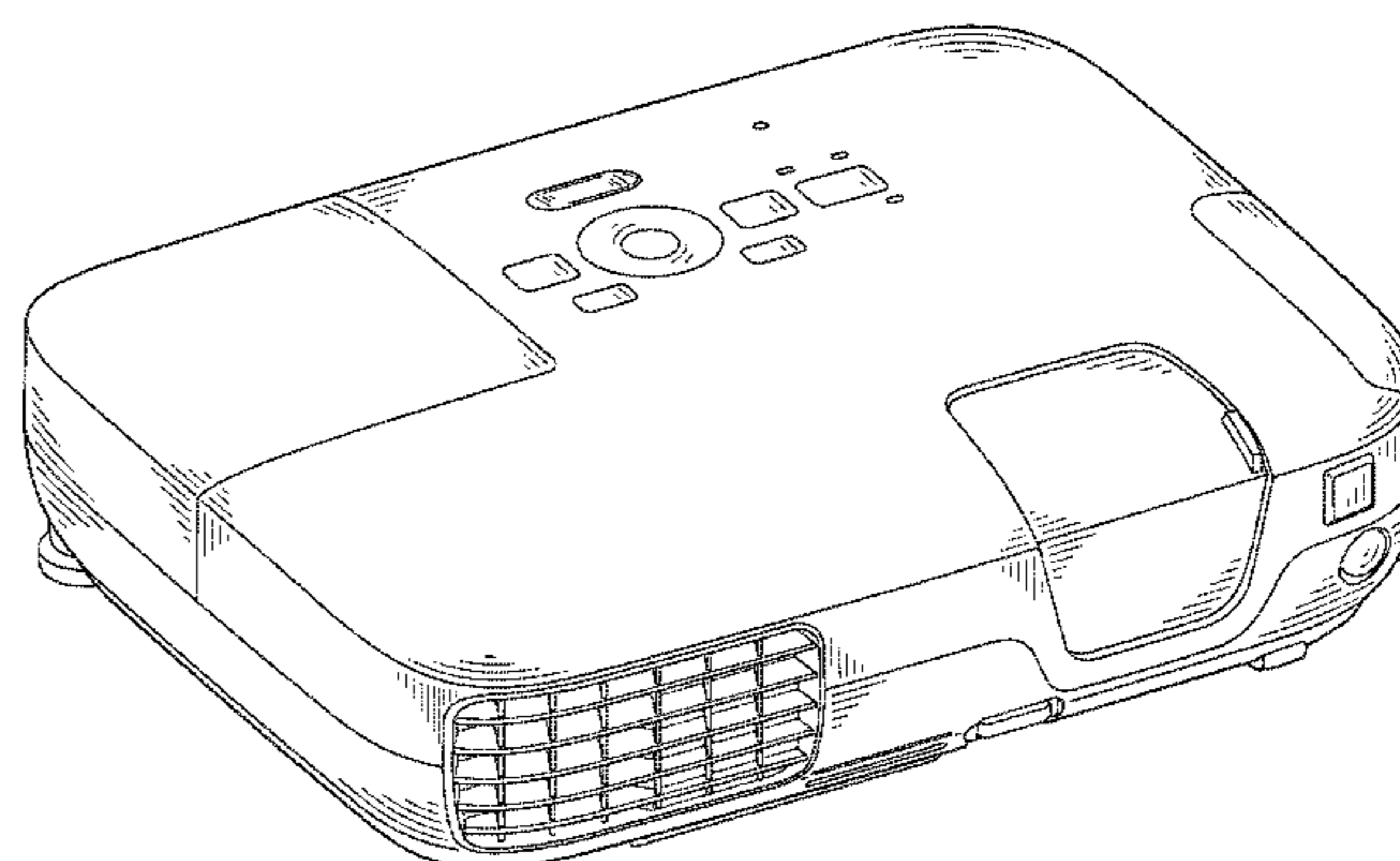
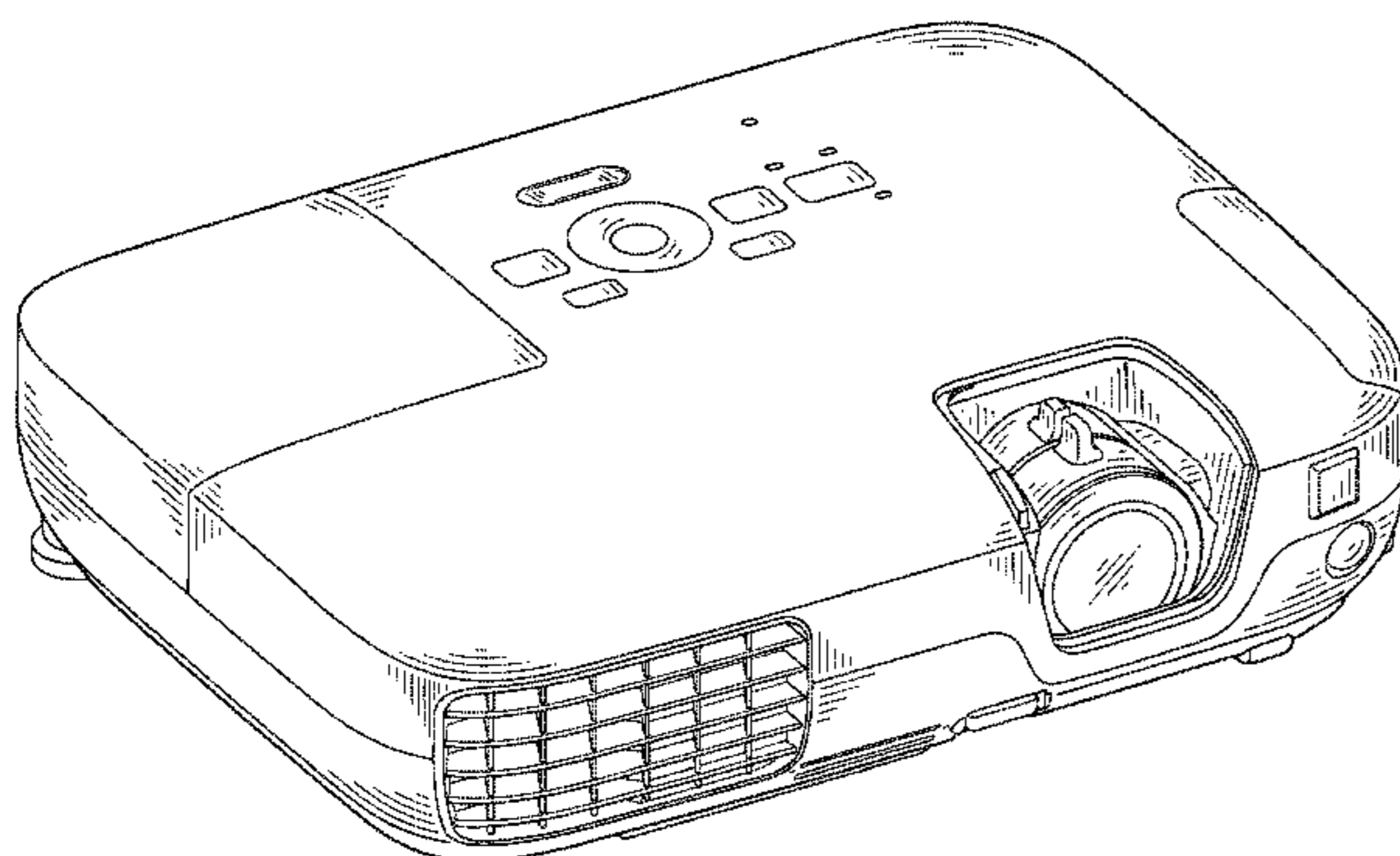

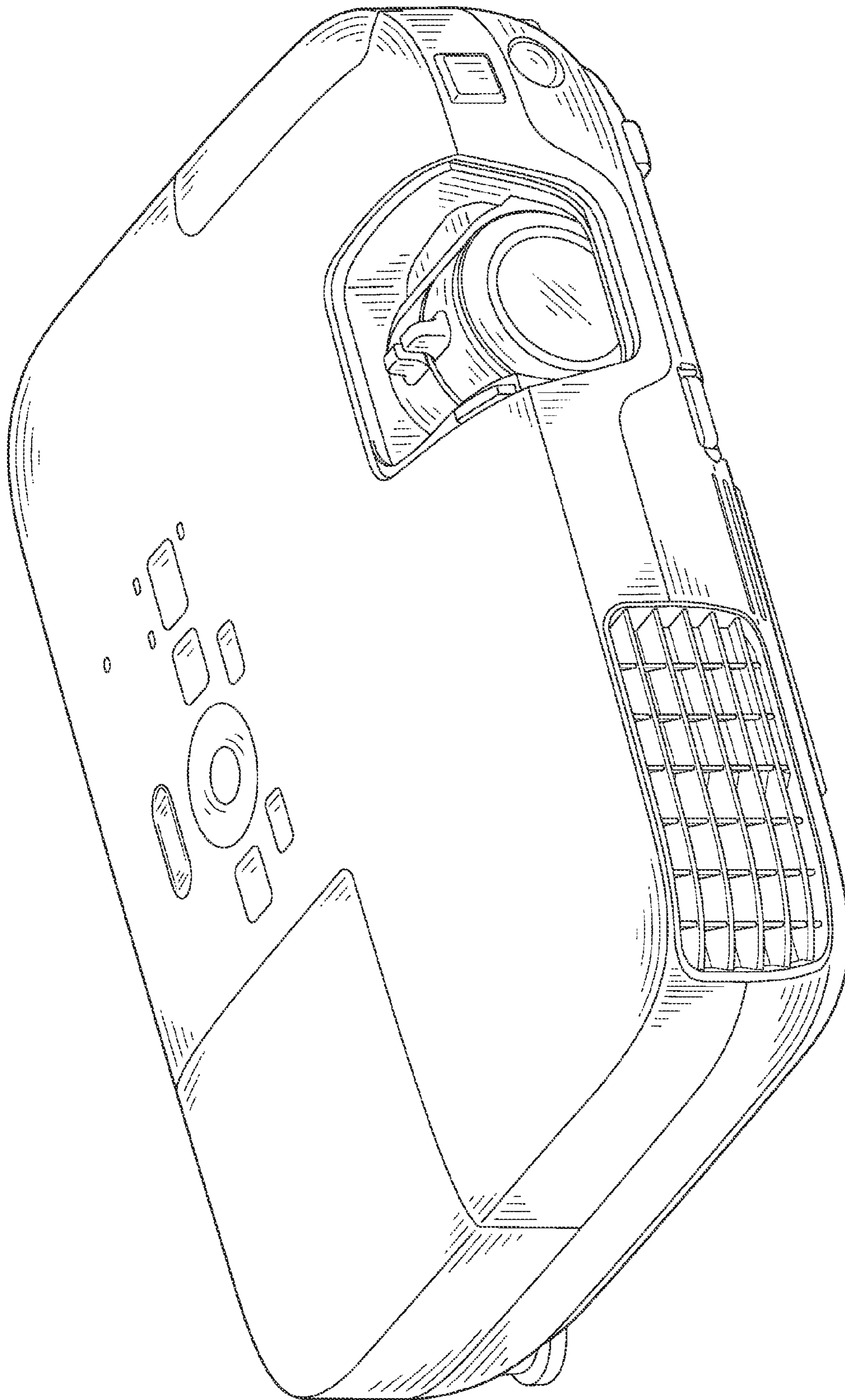

FIG. 1

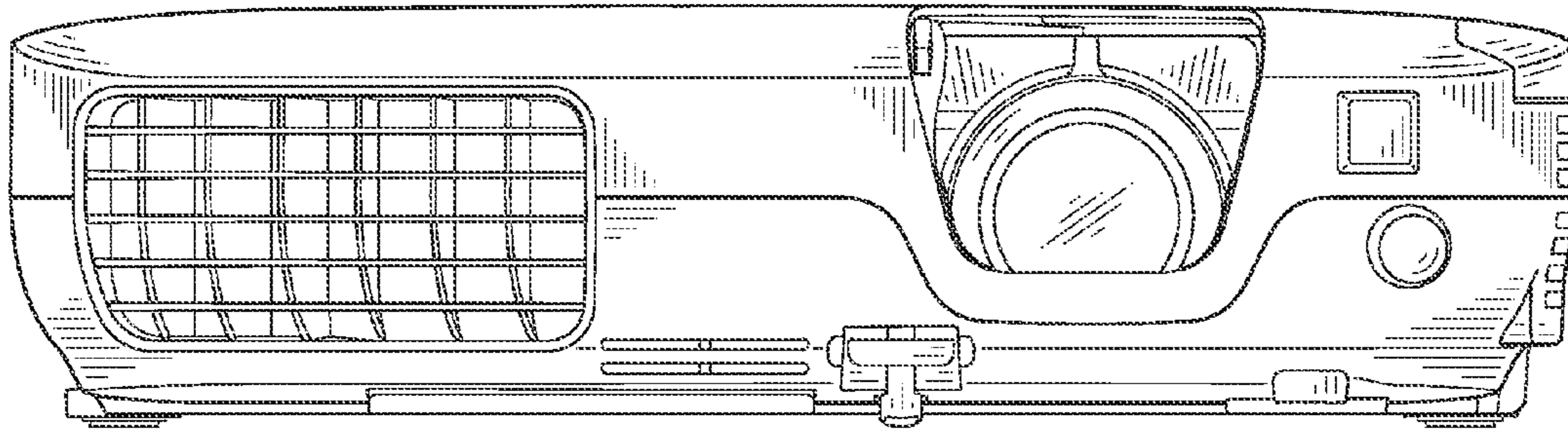

FIG. 2

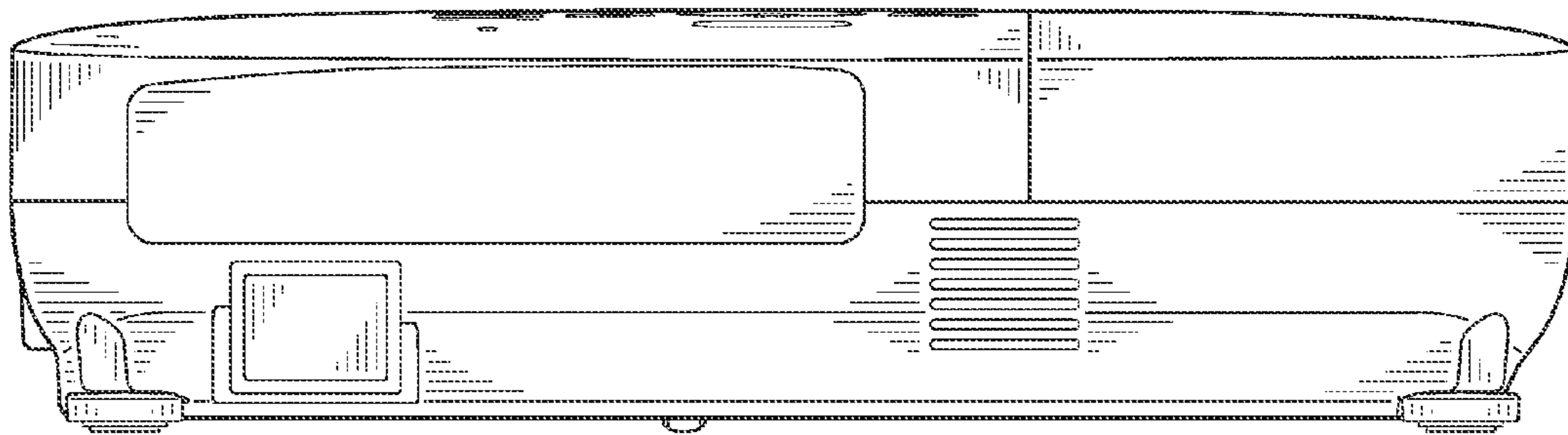

FIG. 3

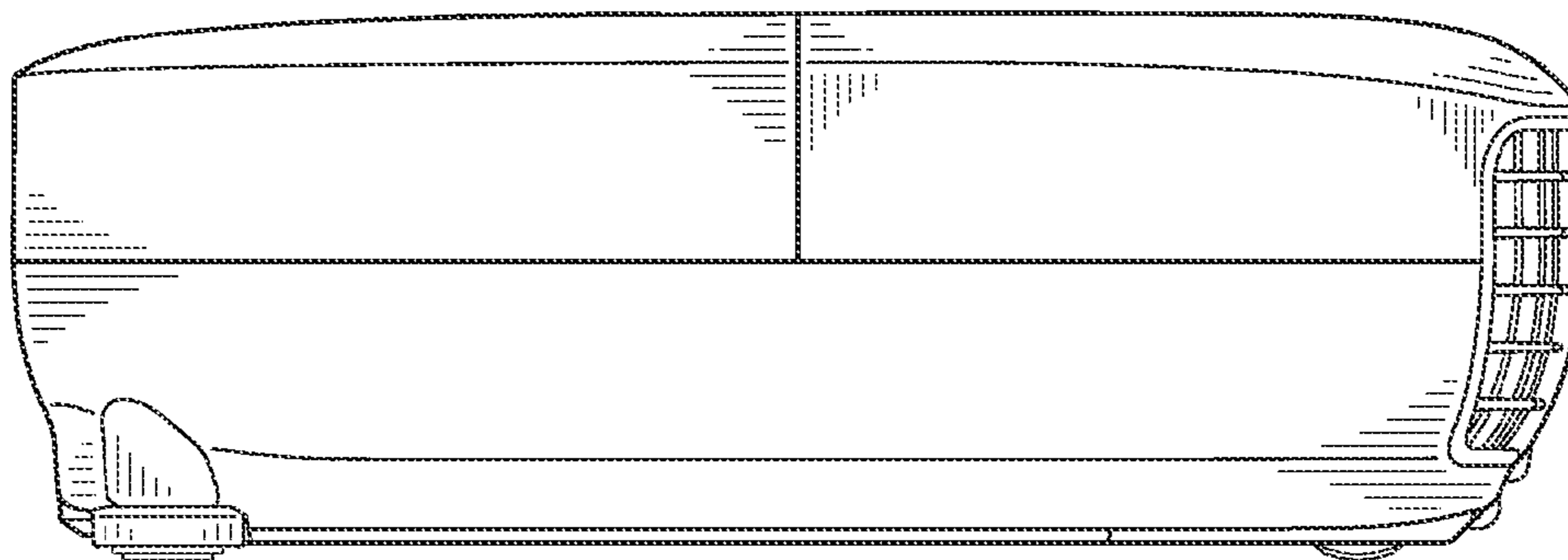

FIG. 4

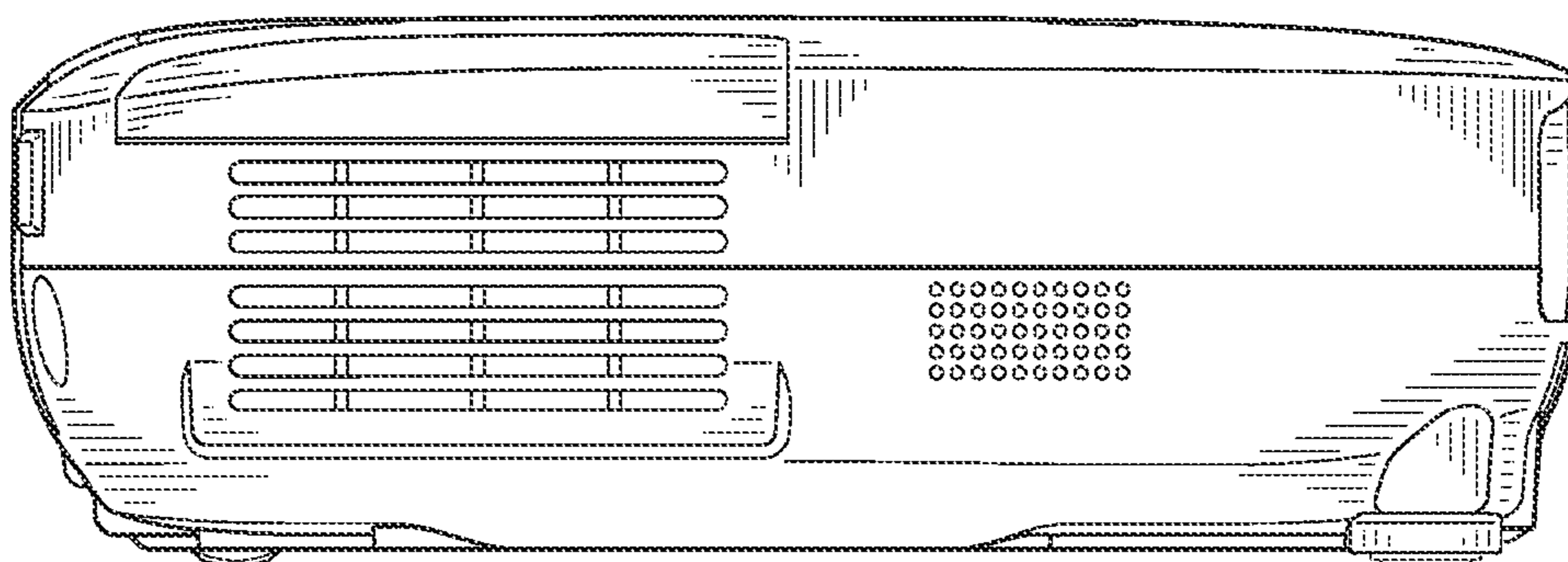

FIG. 5

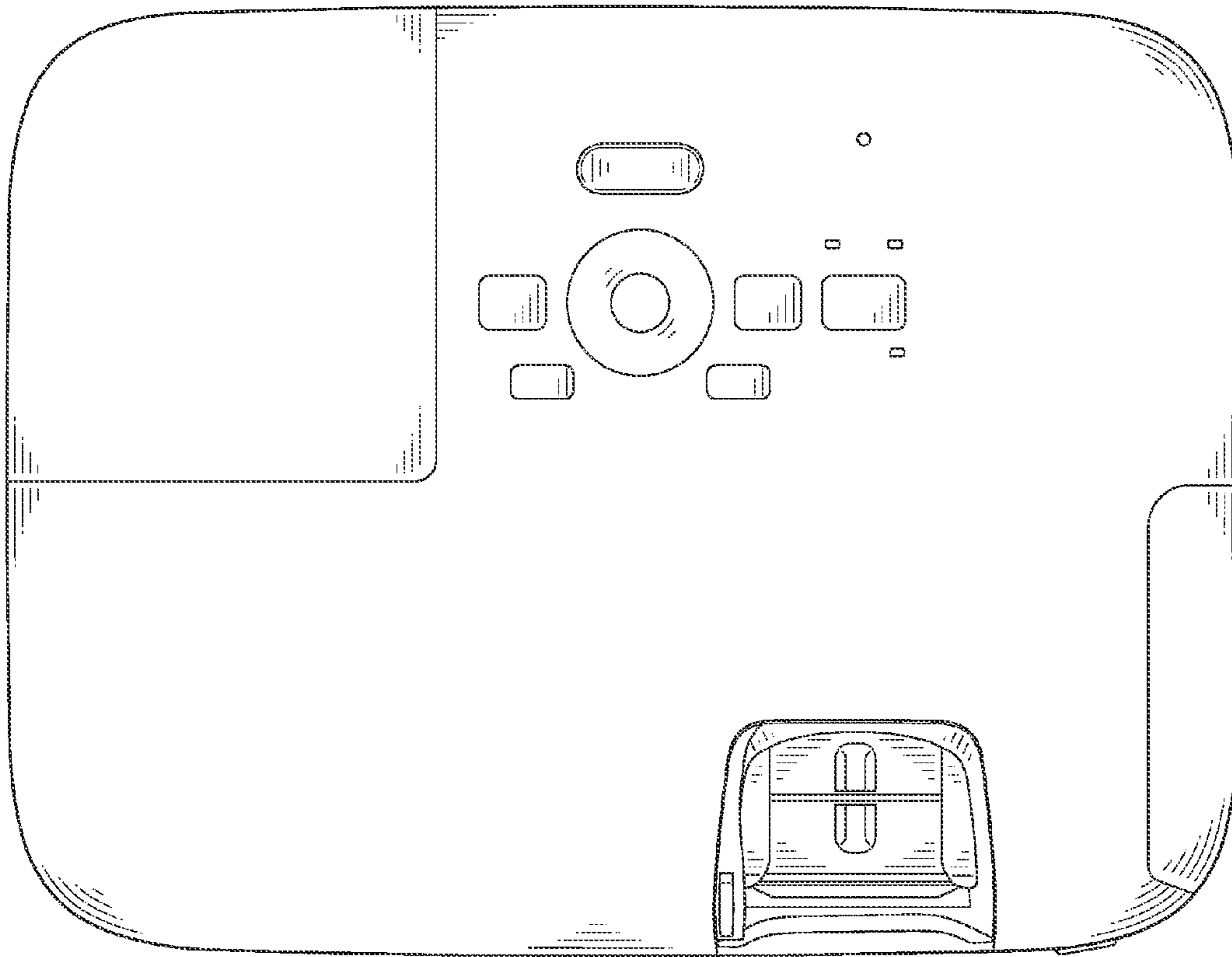

FIG. 6

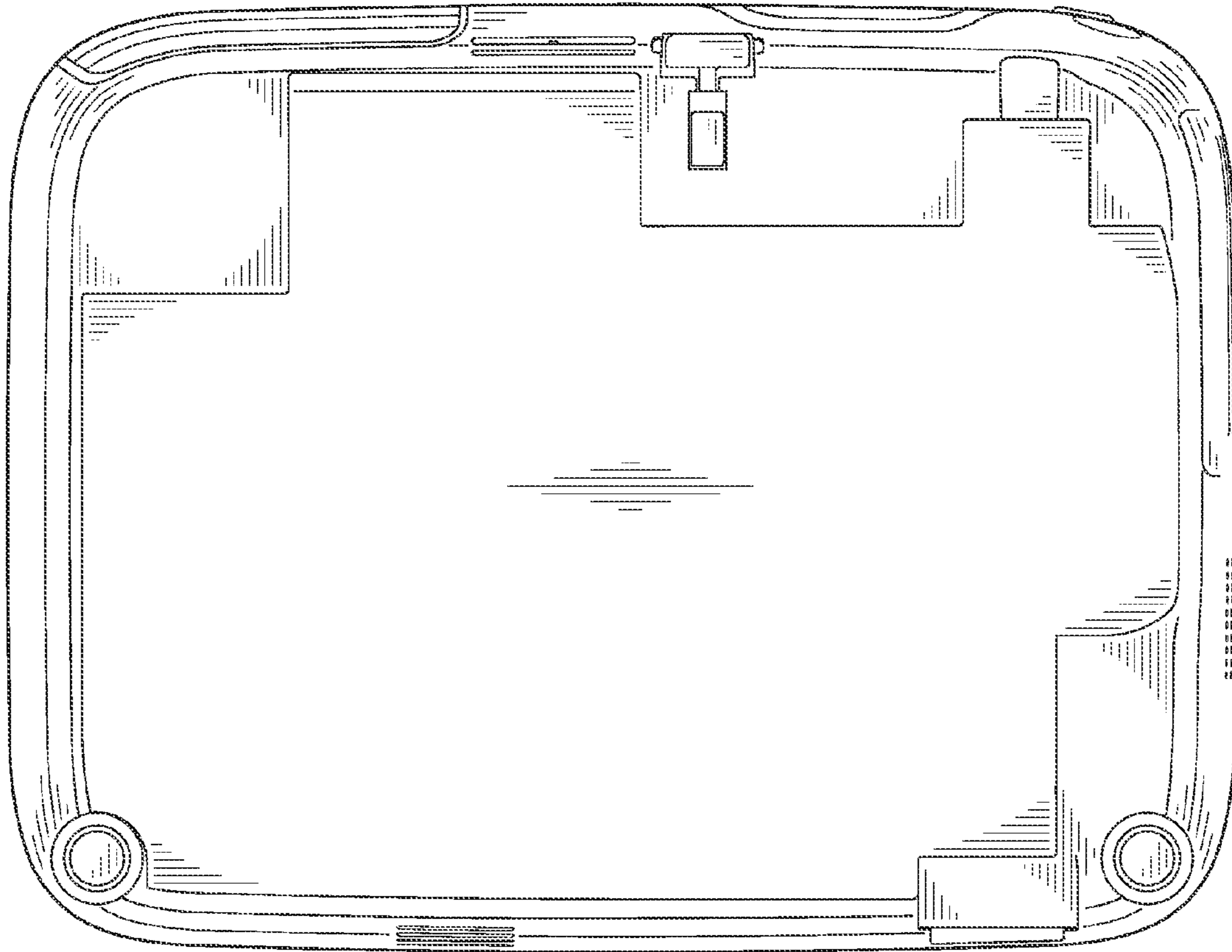

FIG. 7

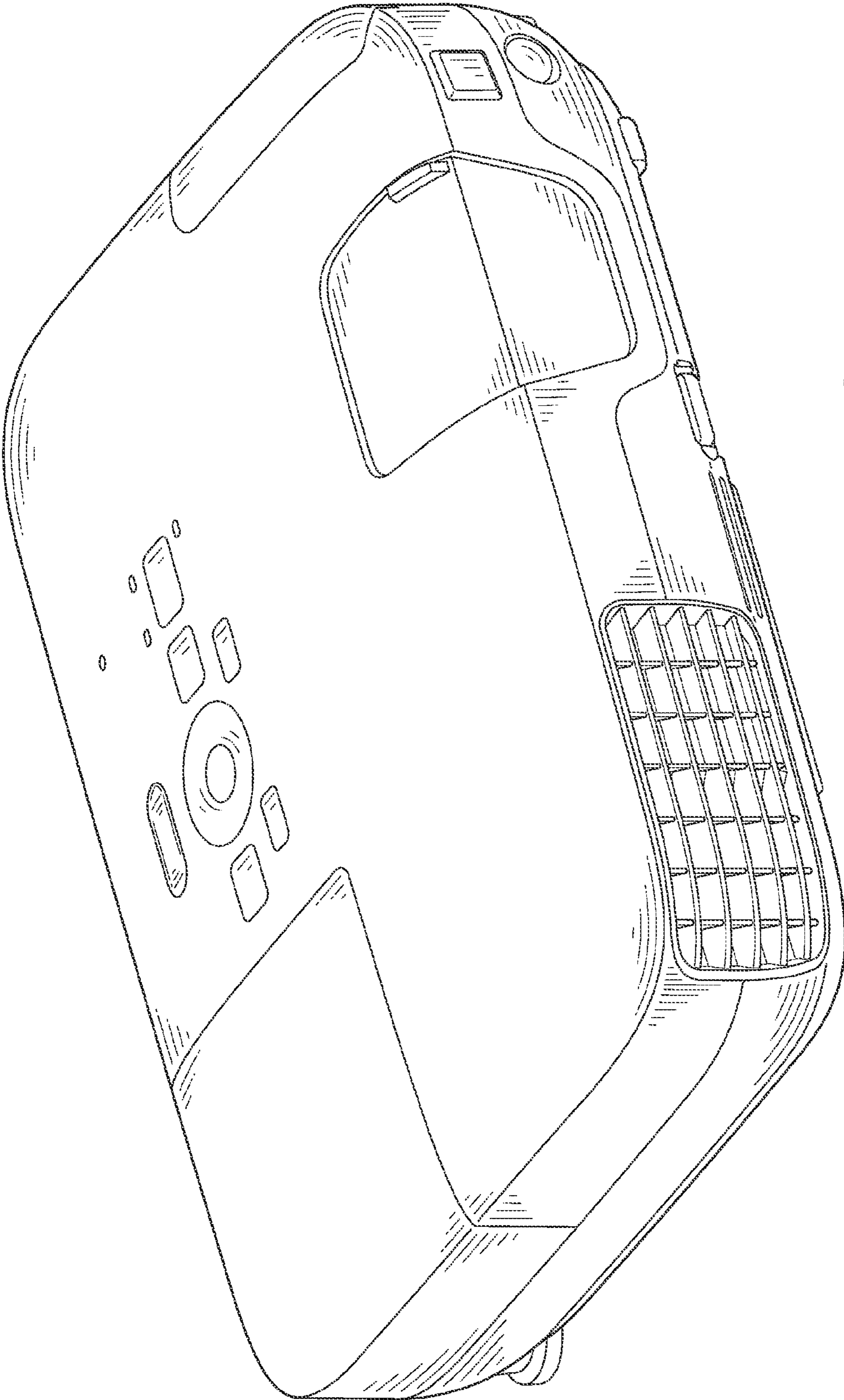

FIG. 8