



US00D614609S

(12) **United States Design Patent**
Arpe et al.

(10) **Patent No.:** **US D614,609 S**
(45) **Date of Patent:** **** Apr. 27, 2010**

(54) **MICROPHONE**

(75) Inventors: **Michael Arpe**, Kiel (DE); **Rene Crain**,
Xanten (DE)

(73) Assignee: **Sennheiser Electronic GmbH & Co.**
KG, Wedemark (DE)

(**) Term: **14 Years**

(21) Appl. No.: **29/332,851**

(22) Filed: **Feb. 26, 2009**

(30) **Foreign Application Priority Data**

Sep. 1, 2008 (EM) 000995188

(51) **LOC (9) Cl.** **14-01**

(52) **U.S. Cl.** **D14/225; D14/228**

(58) **Field of Classification Search** D14/219,
D14/220, 225, 221, 229, 228, 497, 217; 379/
420.01-420.04; 181/129, 130; 455/569.1;
D13/107, 108; 320/110, 113

See application file for complete search history.

(56) **References Cited**

U.S. PATENT DOCUMENTS

D462,947 S *	9/2002	Kung	D14/228
D498,232 S *	11/2004	Ruhrig	D14/228
D525,193 S *	7/2006	Vu	D13/108
D530,705 S *	10/2006	Shen	D14/225
D532,746 S *	11/2006	Meyers et al.	D13/108
D535,612 S *	1/2007	Chien	D13/107
D549,646 S *	8/2007	Sade et al.	D13/108
D551,617 S *	9/2007	Houghton	D13/108
D557,690 S *	12/2007	Lee	D14/228
D579,445 S *	10/2008	Lee	D14/228

D585,434 S *	1/2009	Ganley et al.	D14/228
D589,032 S *	3/2009	Lee	D14/228
D593,998 S *	6/2009	Bentley et al.	D14/224

* cited by examiner

Primary Examiner—Paula Greene

(74) *Attorney, Agent, or Firm*—Townsend and Townsend and
Crew LLP

(57) **CLAIM**

The ornamental design for a microphone, as shown and
described.

DESCRIPTION

FIG. 1 is a right side view of a microphone according to my
new design;

FIG. 2 is a bottom plan view thereof;

FIG. 3 is a left side view thereof;

FIG. 4 is a top plan view thereof;

FIG. 5 is a rear view thereof;

FIG. 6 is a front view thereof;

FIG. 7 is a three-dimensional perspective view thereof;

FIG. 8 is a three-dimensional right side view thereof;

FIG. 9 is a three-dimensional left side view thereof;

FIG. 10 is a three-dimensional bottom plan view thereof;

FIG. 11 is a three-dimensional top plan view thereof;

FIG. 12 is a three-dimensional rear view thereof; and,

FIG. 13 is a three-dimensional front view thereof.

The broken lines shown in the drawings form no part of the
claimed design.

1 Claim, 8 Drawing Sheets

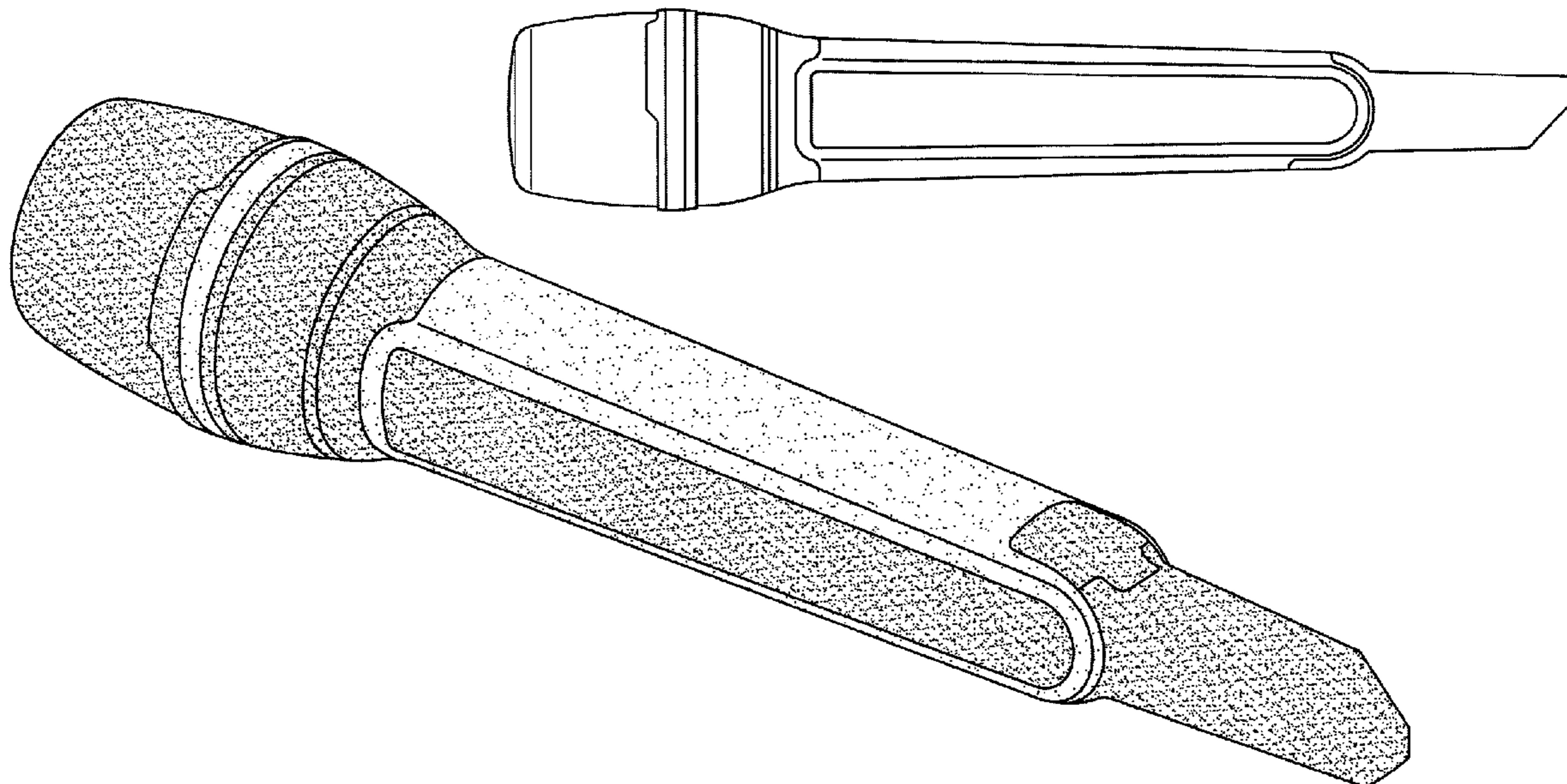

FIG. 1

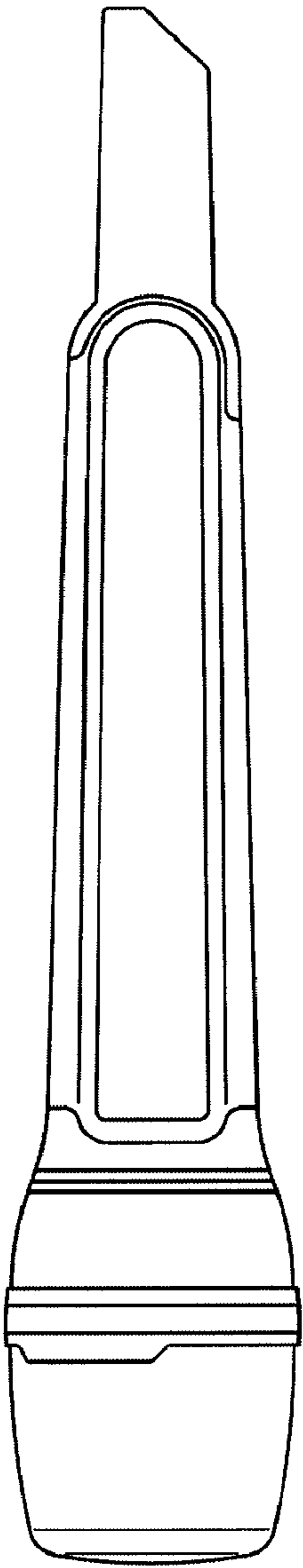

FIG. 2

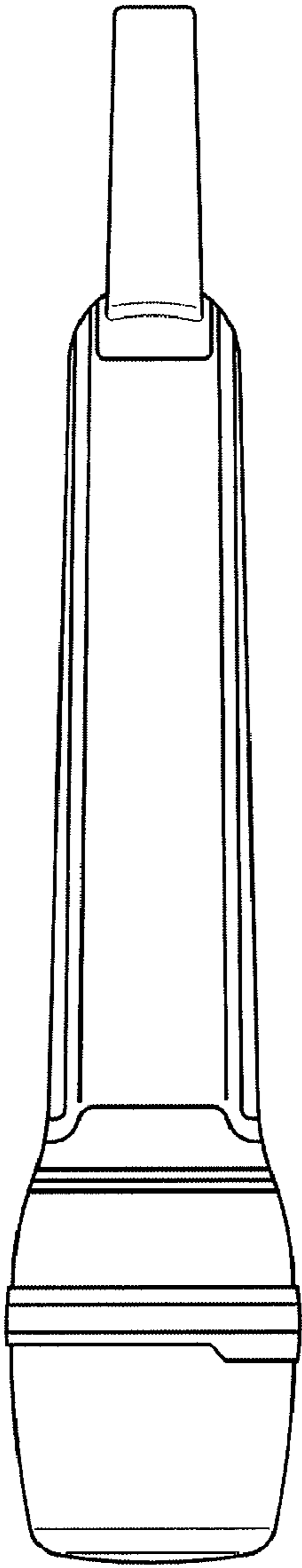

FIG. 3

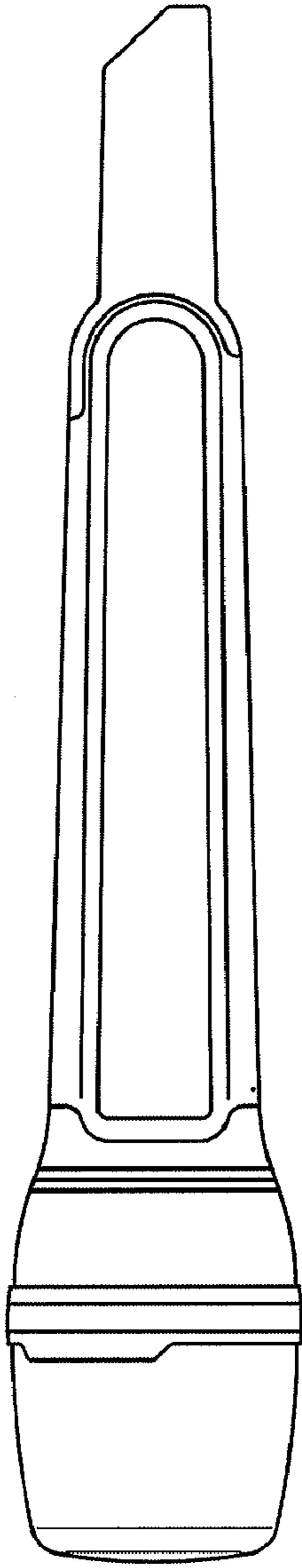
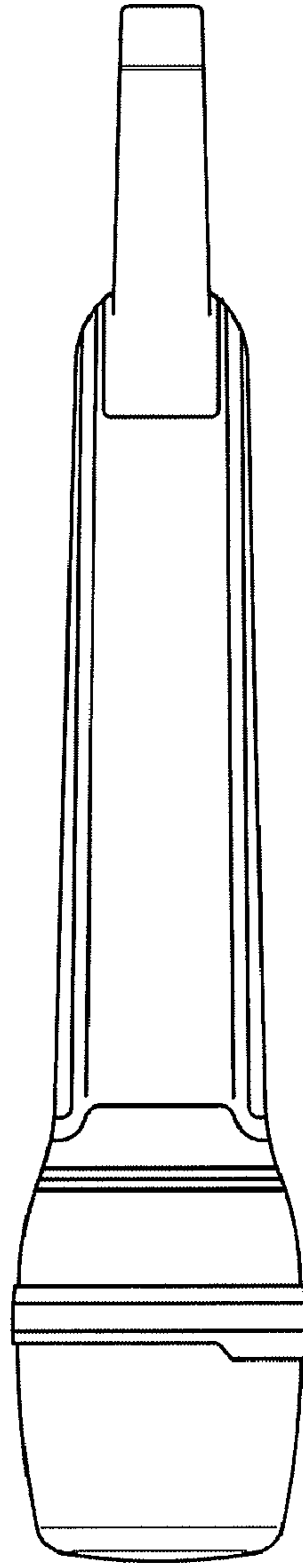

FIG. 4



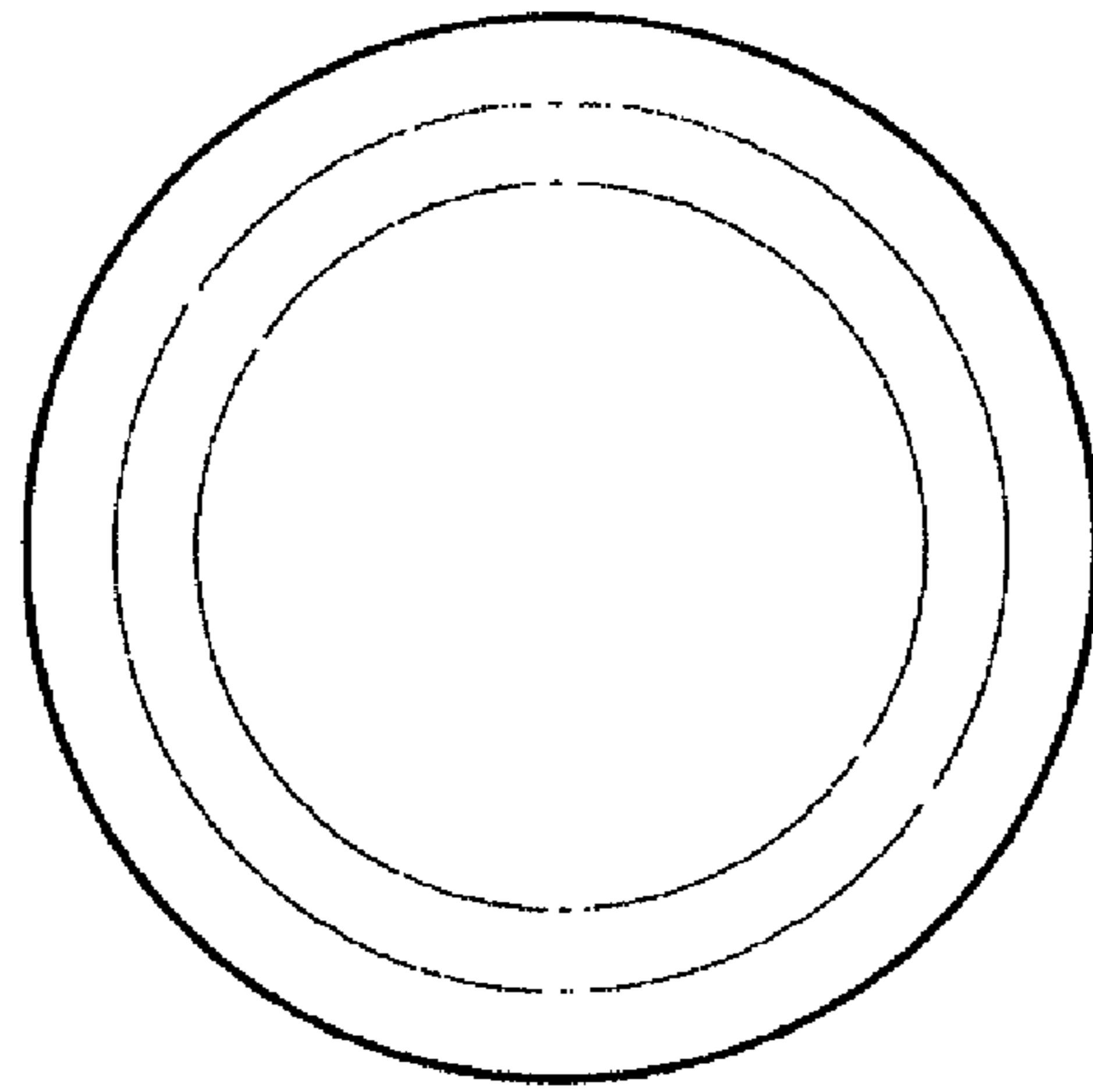

FIG. 6

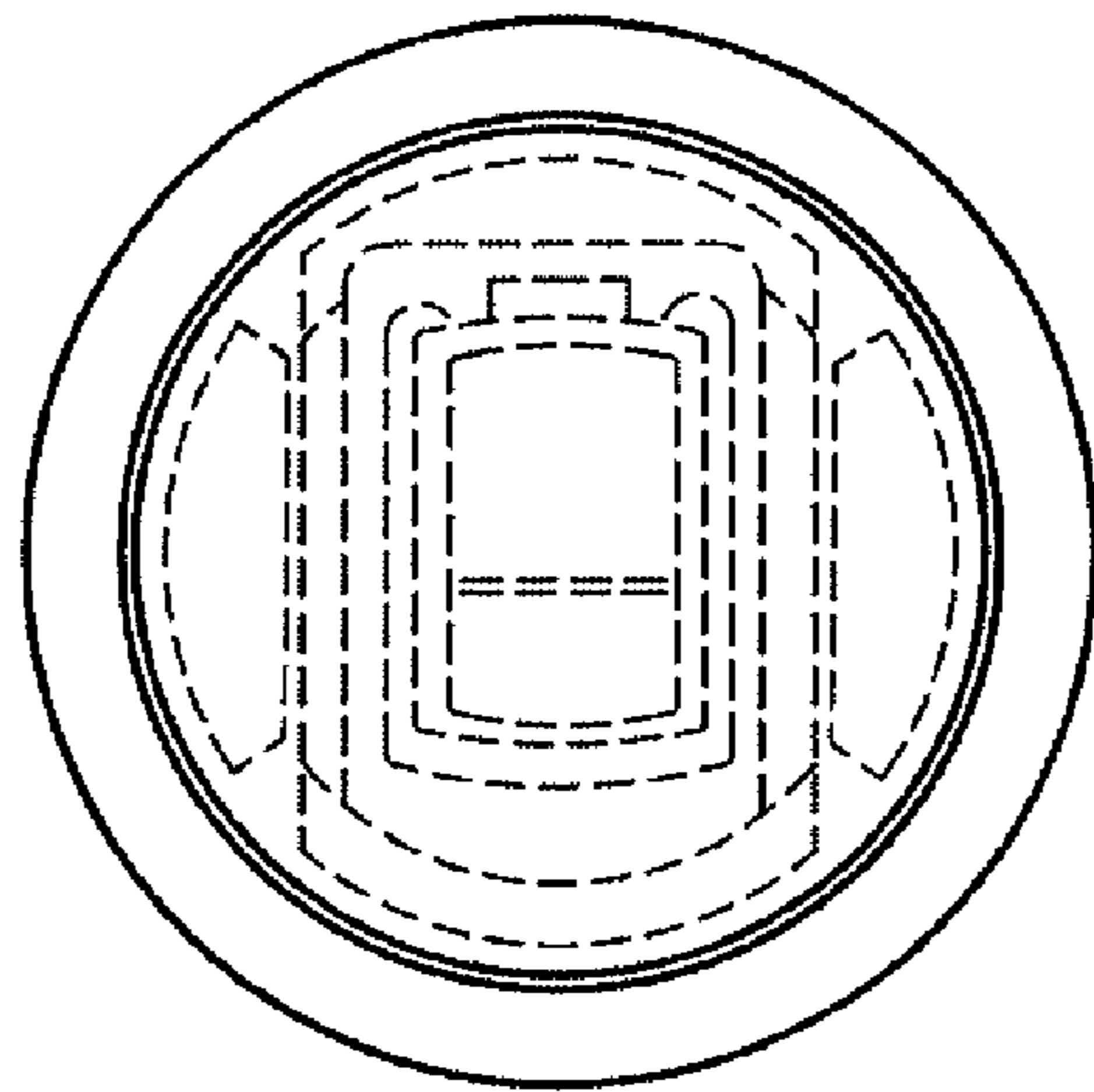

FIG. 5

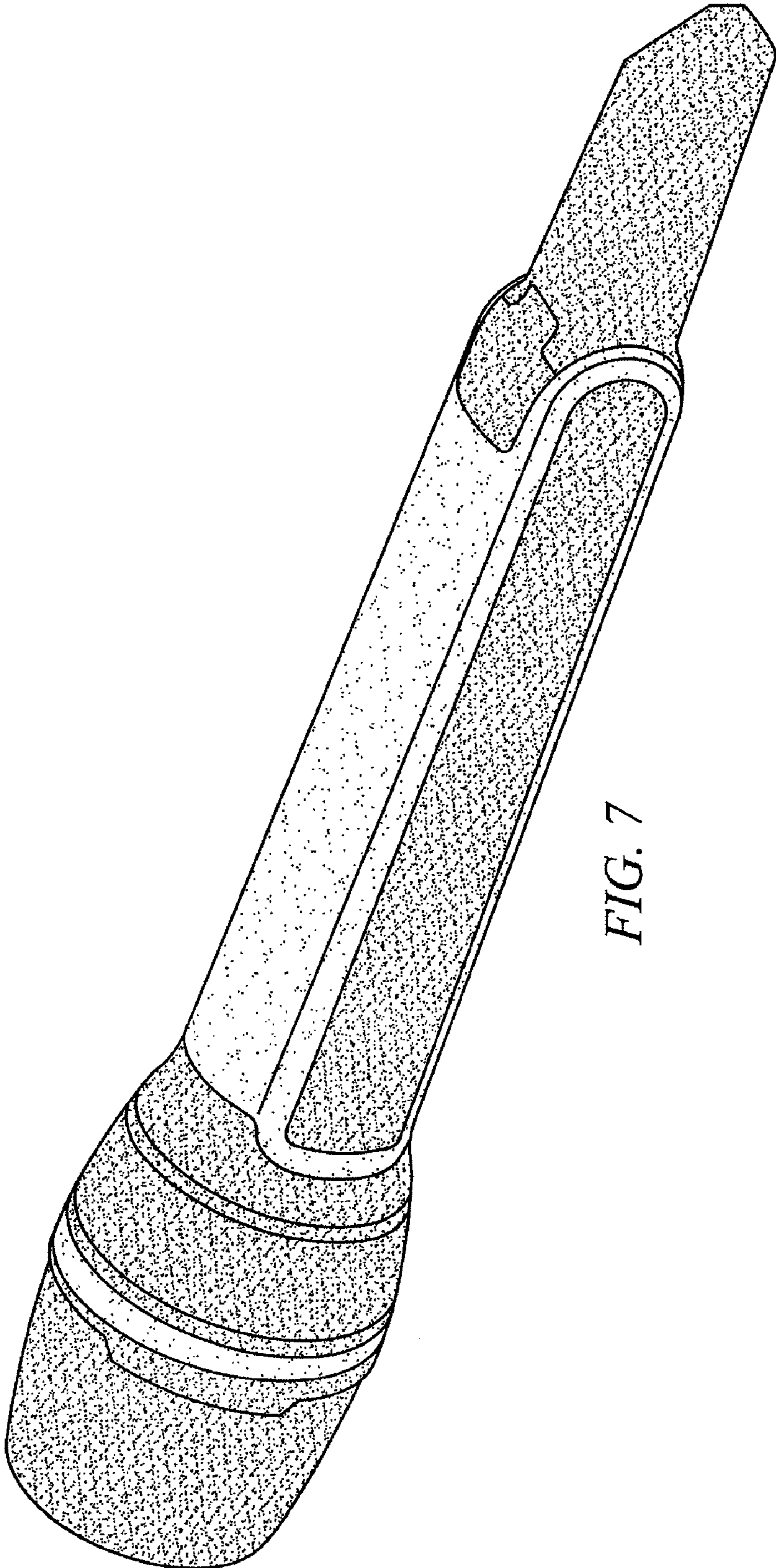

FIG. 7

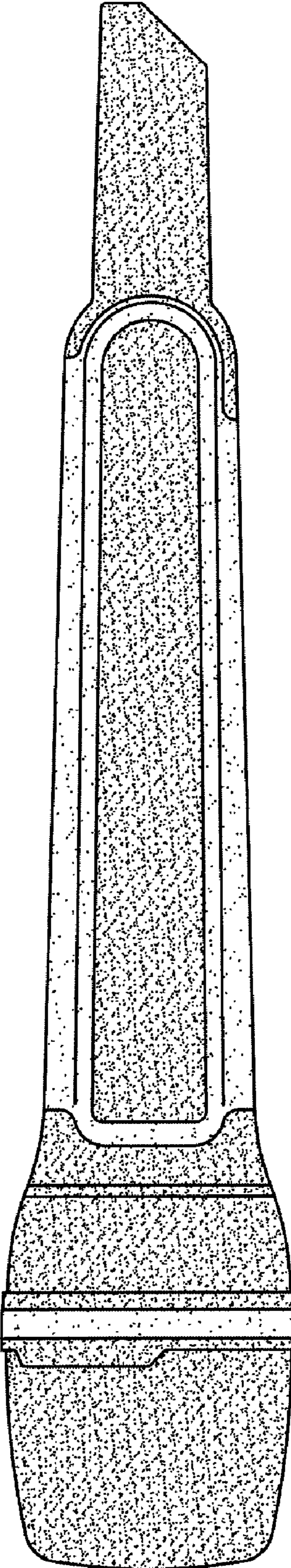

FIG. 8

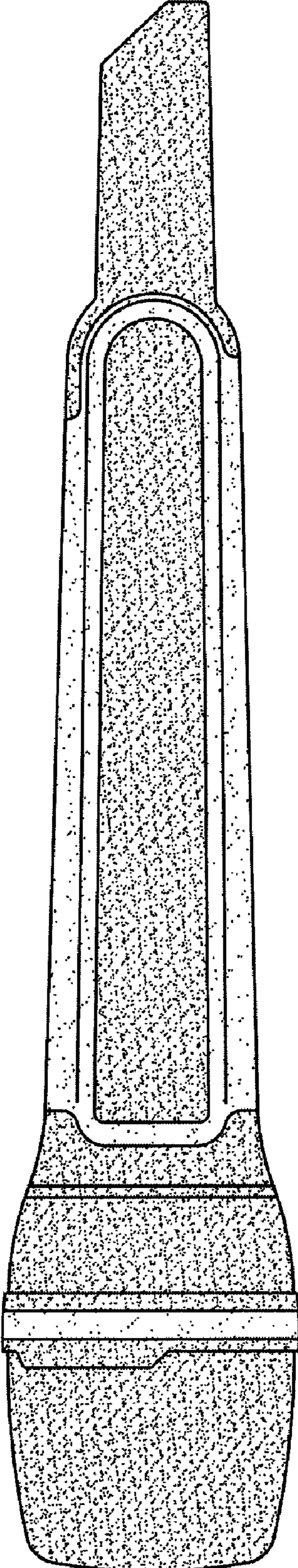

FIG. 9

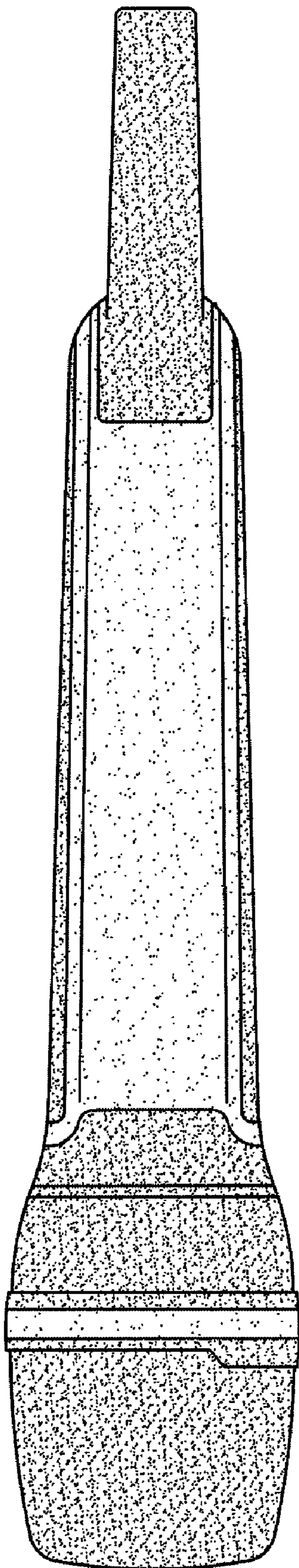

FIG. 10

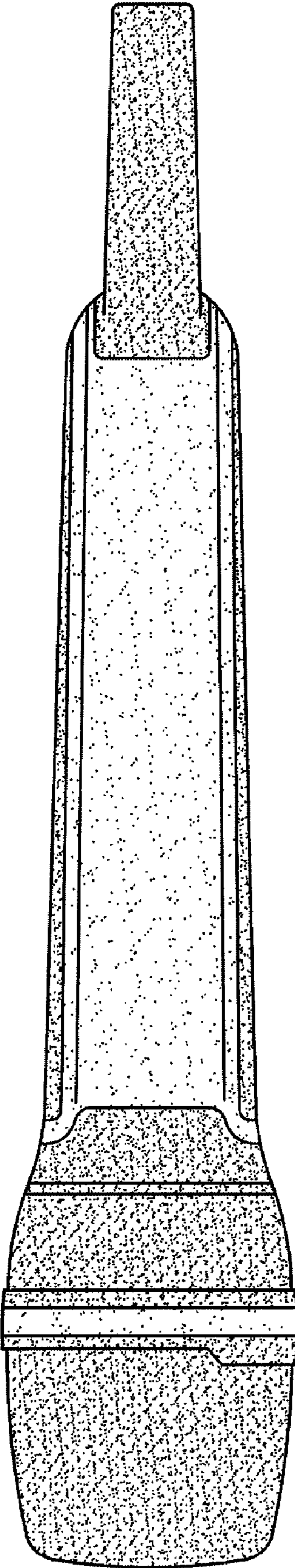

FIG. 11

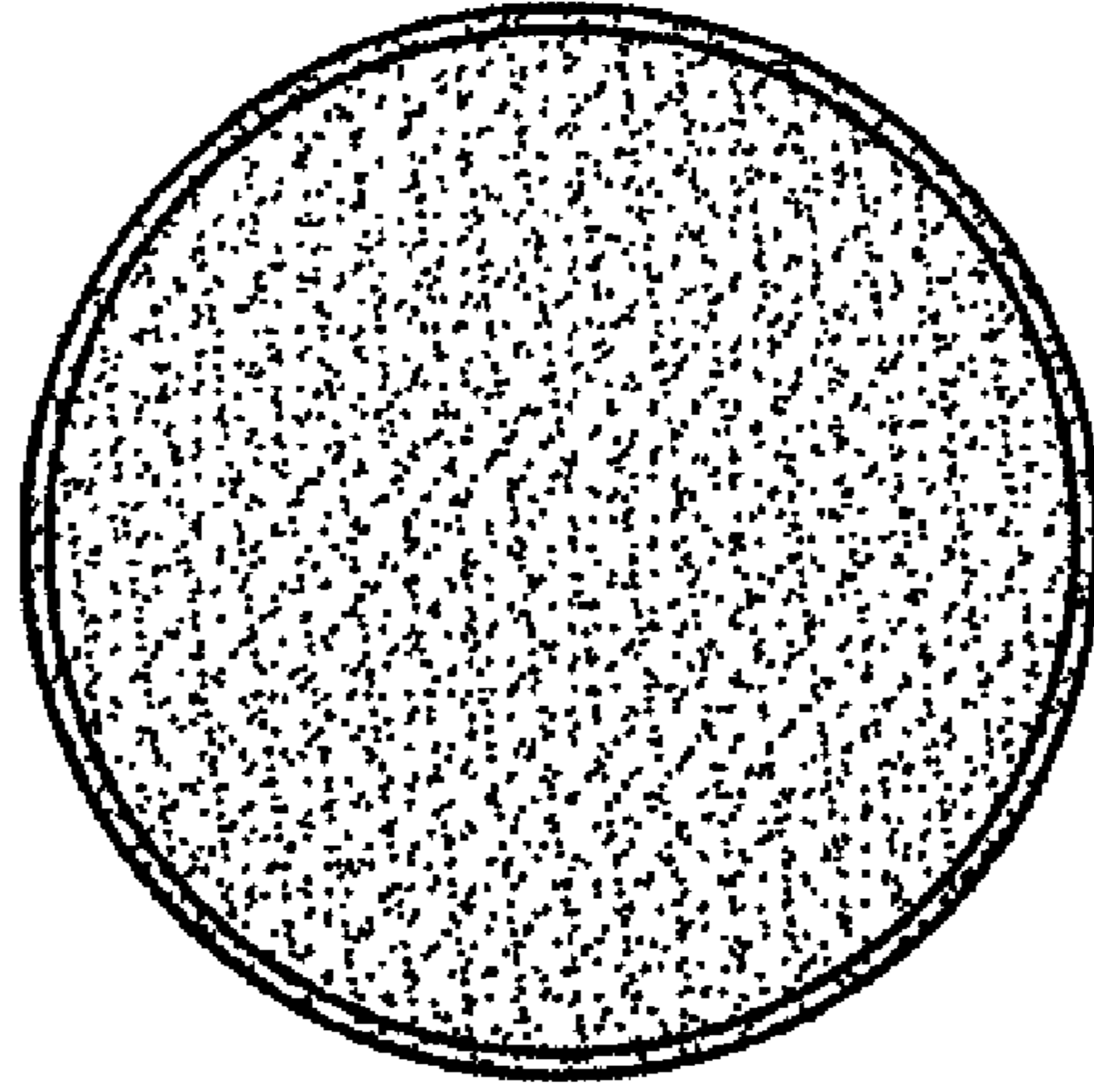

FIG. 13

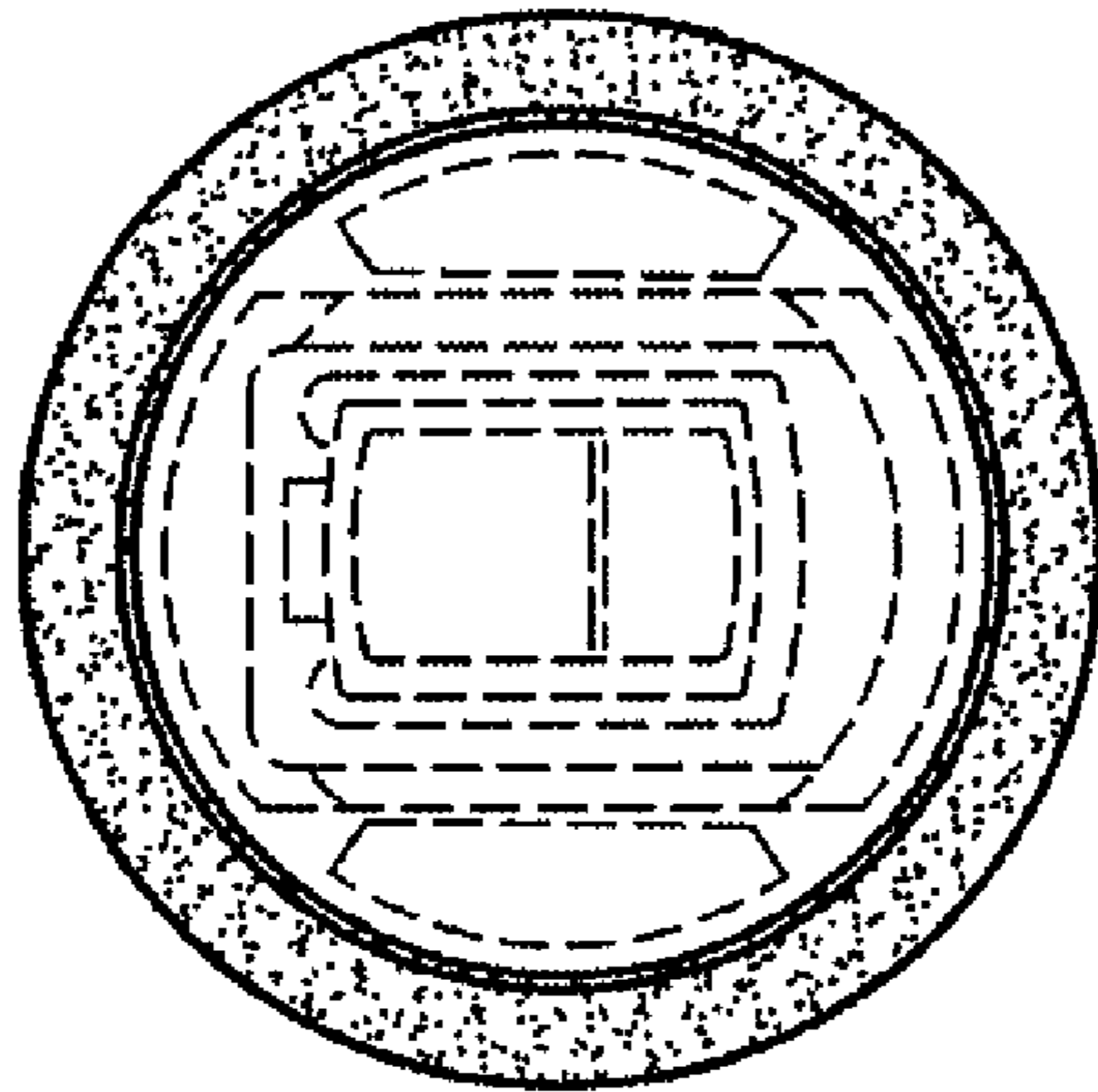

FIG. 12