



US00D614433S

(12) **United States Design Patent**
Leavens

(10) **Patent No.:** **US D614,433 S**
(45) **Date of Patent:** **** Apr. 27, 2010**

(54) **BARBEQUE**

(75) Inventor: **Benjamin John Leavens**, Woollahra (AU)

(73) Assignee: **Shriro Australia Pty Limited**, New South Wales (AU)

(**) Term: **14 Years**

(21) Appl. No.: **29/324,011**

(22) Filed: **Sep. 4, 2008**

(30) **Foreign Application Priority Data**

Mar. 10, 2008 (AU) 11159/2008
Mar. 10, 2008 (AU) 11160/2008
Mar. 10, 2008 (AU) 11161/2008

(51) **LOC (9) Cl.** **07-02**

(52) **U.S. Cl.** **D7/334**

(58) **Field of Classification Search** D7/332,
D7/334-337, 402-406; 126/25 R, 9 R, 37 R,
126/41 R, 40, 42, 50, 9 A, 9 B, 299 C, 98,
126/201, 43-44, 48, 38

See application file for complete search history.

(56) **References Cited**

U.S. PATENT DOCUMENTS

D483,983 S * 12/2003 Harrod et al. D7/334

D501,116 S * 1/2005 Zhang D7/334
D546,116 S * 7/2007 Tseng D7/334
D546,616 S * 7/2007 Tseng D7/334
D560,417 S * 1/2008 Ho et al. D7/334
D566,456 S * 4/2008 Profitt D7/334
D569,168 S * 5/2008 Pai D7/334
D586,609 S * 2/2009 Chau D7/334

* cited by examiner

Primary Examiner—Ruth McInroy

(74) *Attorney, Agent, or Firm*—Patterson, Thunte, Skaar & Christensen, P.A.

(57) **CLAIM**

The ornamental design for a barbecue, as shown and described.

DESCRIPTION

FIG. 1 is a front perspective view of a barbecue showing my new design;

FIG. 2 is a front elevation view thereof;

FIG. 3 is a right side elevation view thereof;

FIG. 4 is a top plan view thereof;

FIG. 5 is a rear elevation view thereof; and,

FIG. 6 is a left side elevation view thereof.

The details shown in broken lines in FIG. 6 form no part of the claimed design.

1 Claim, 3 Drawing Sheets

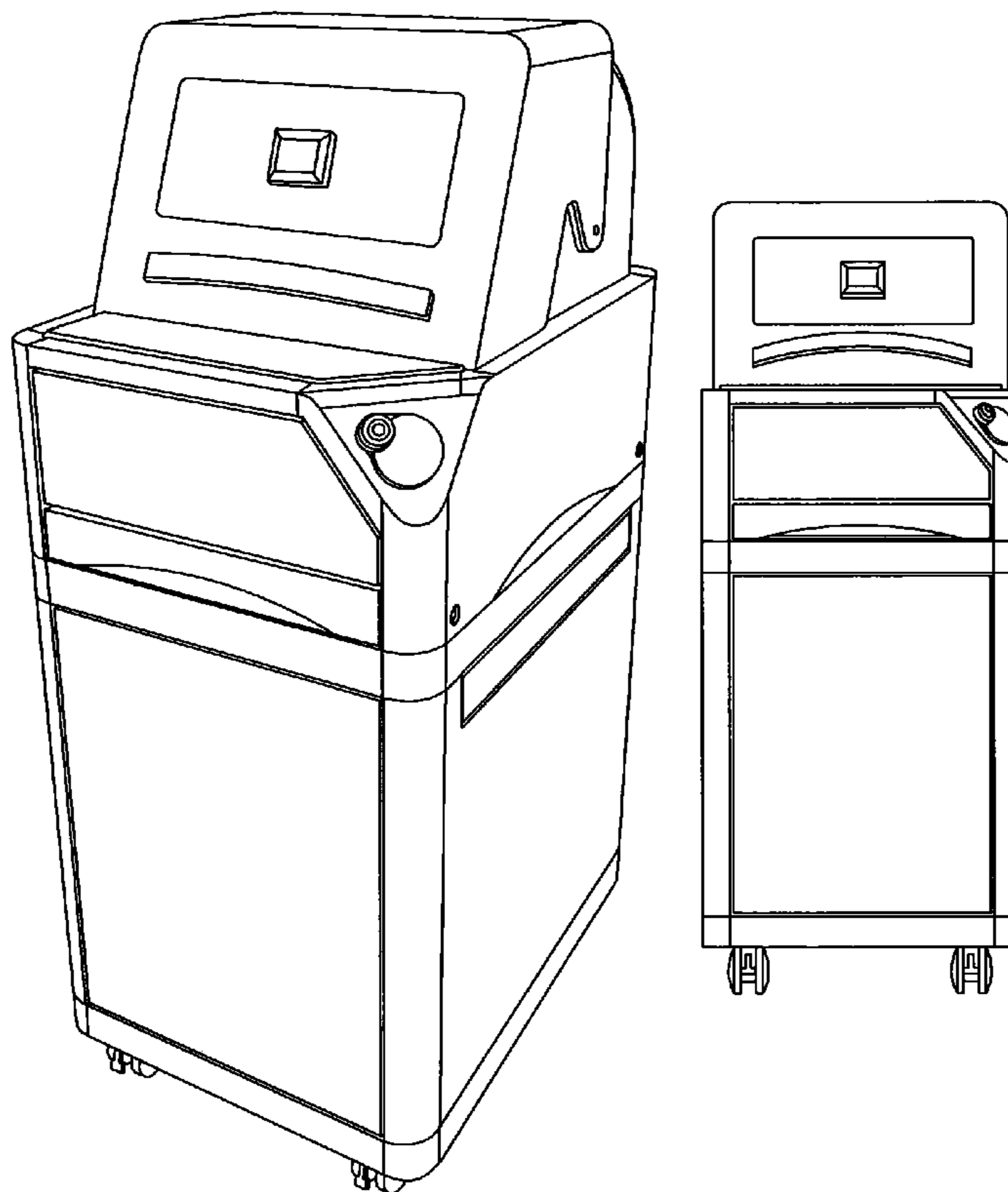

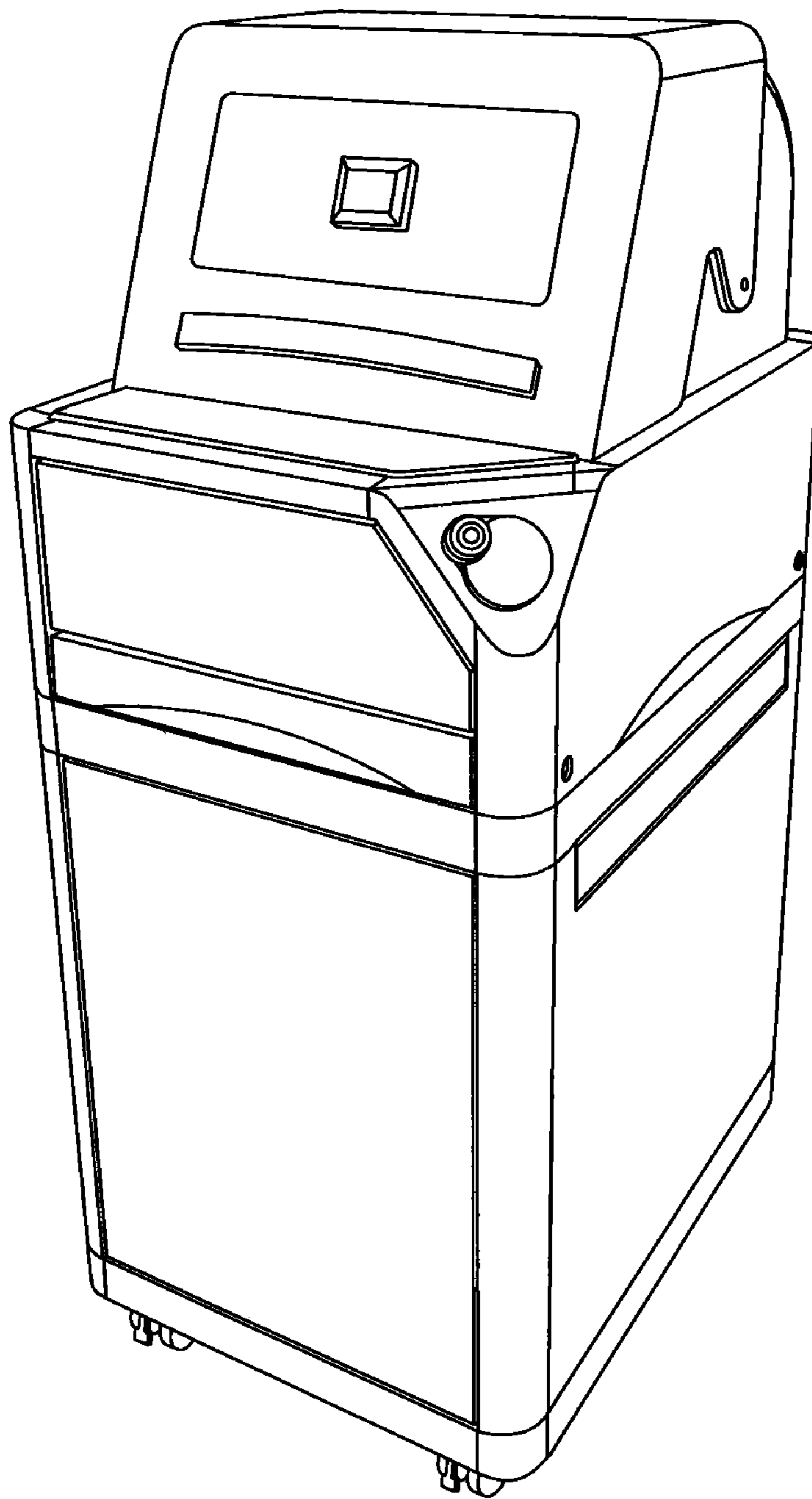

Fig. 1

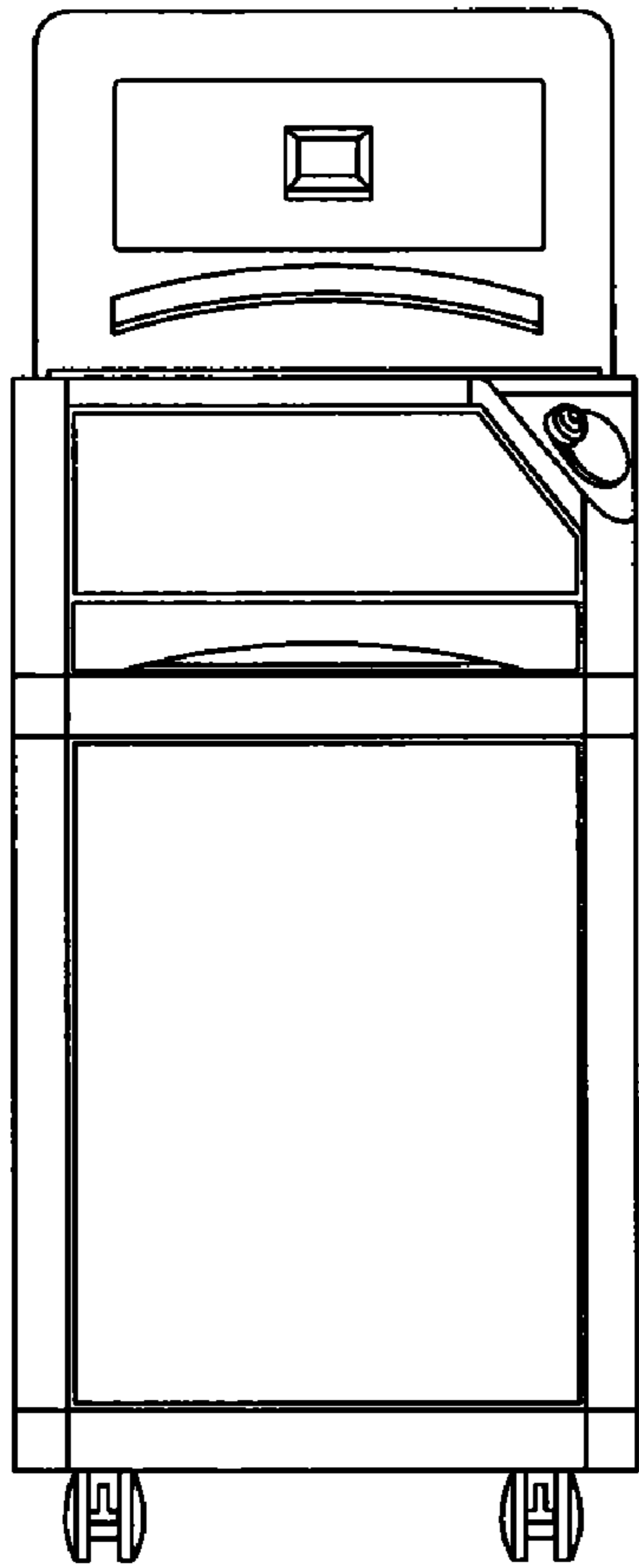

Fig. 2

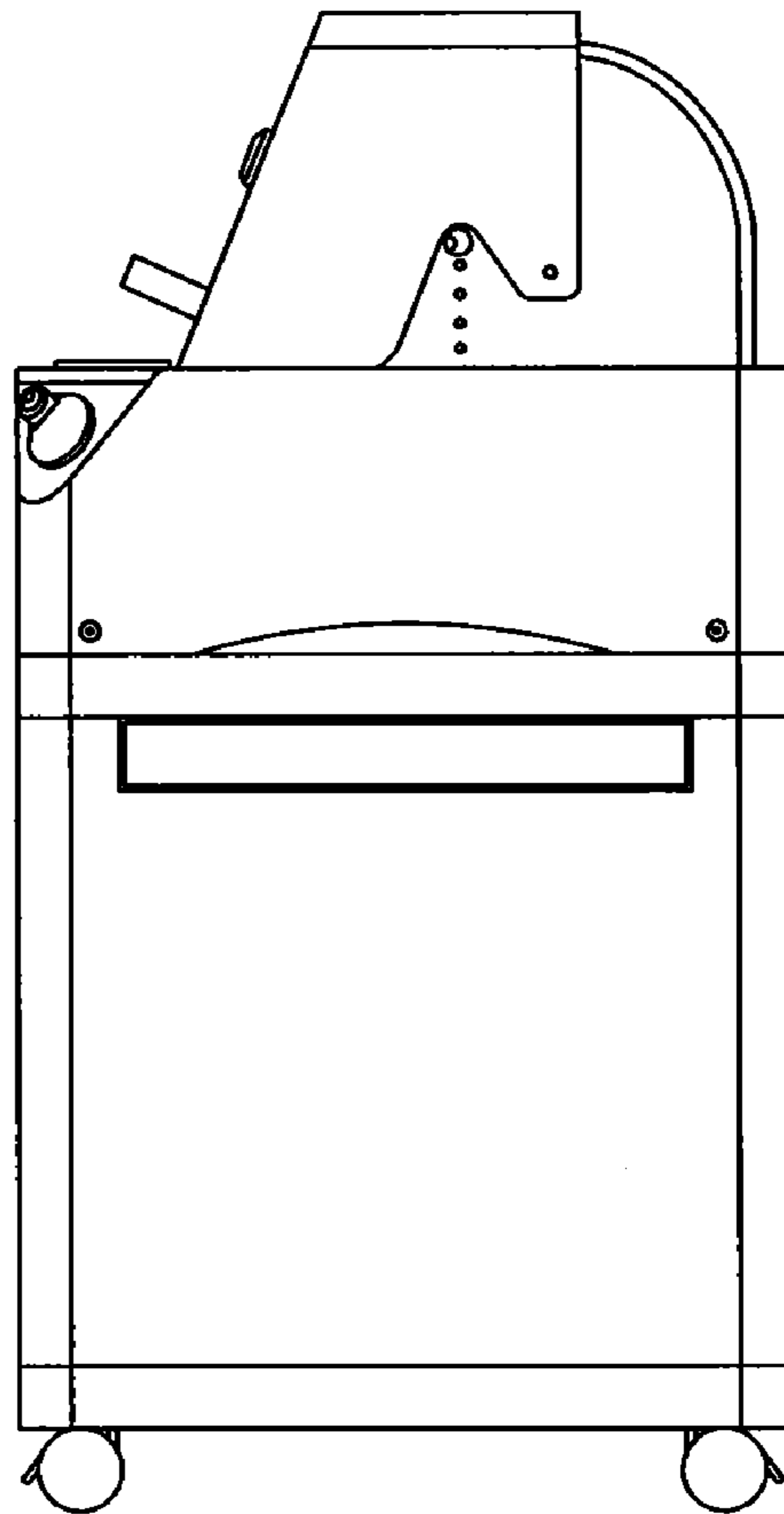

Fig. 3

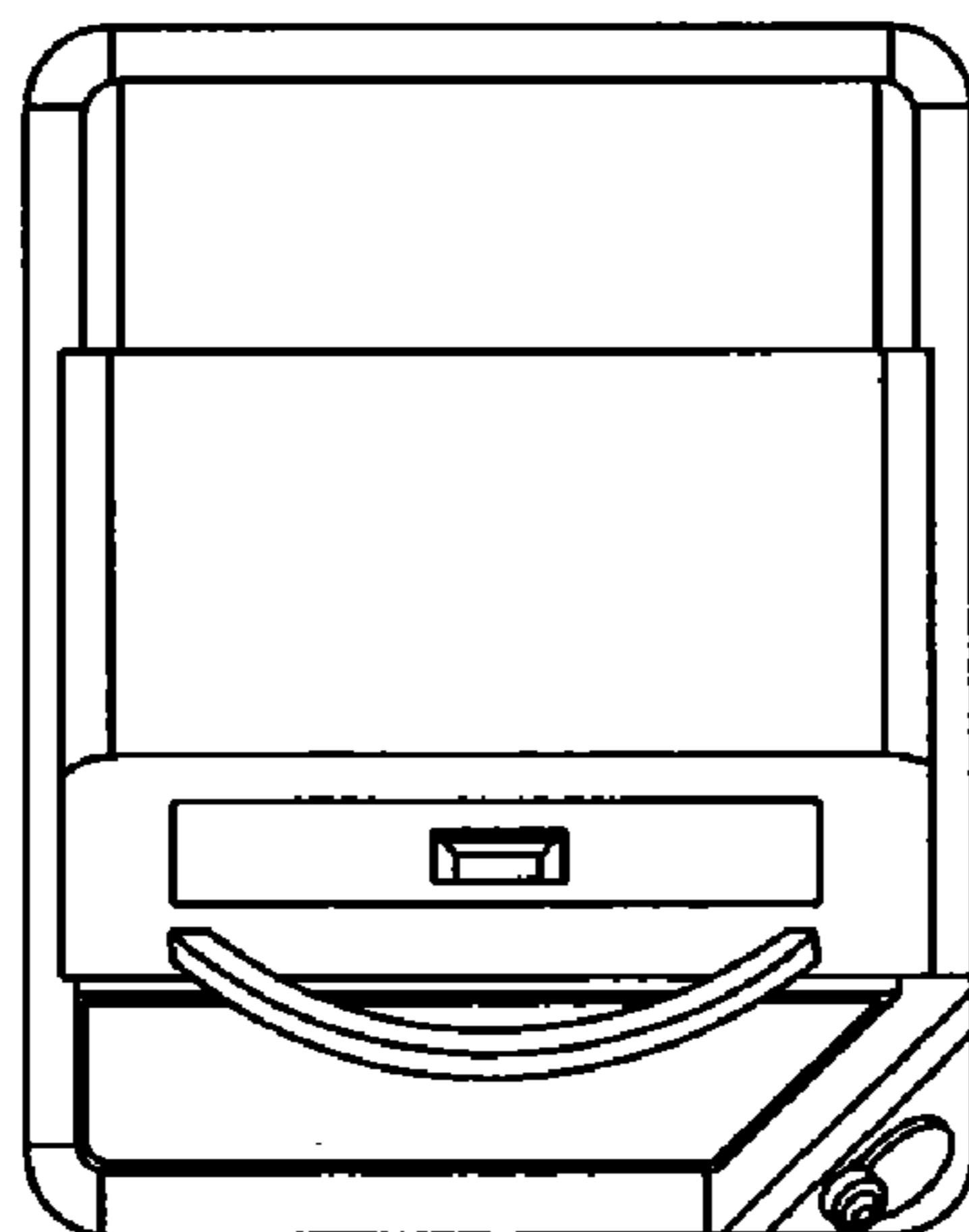

Fig. 4

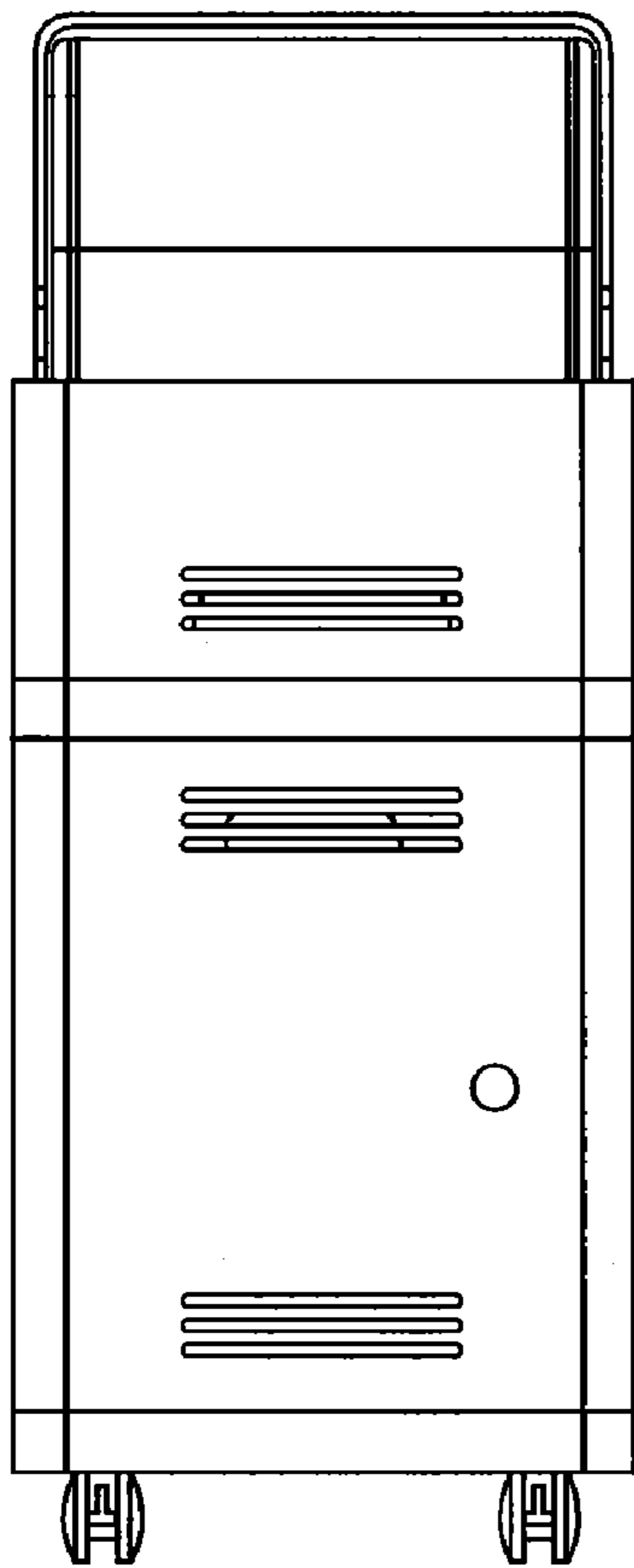

Fig. 5

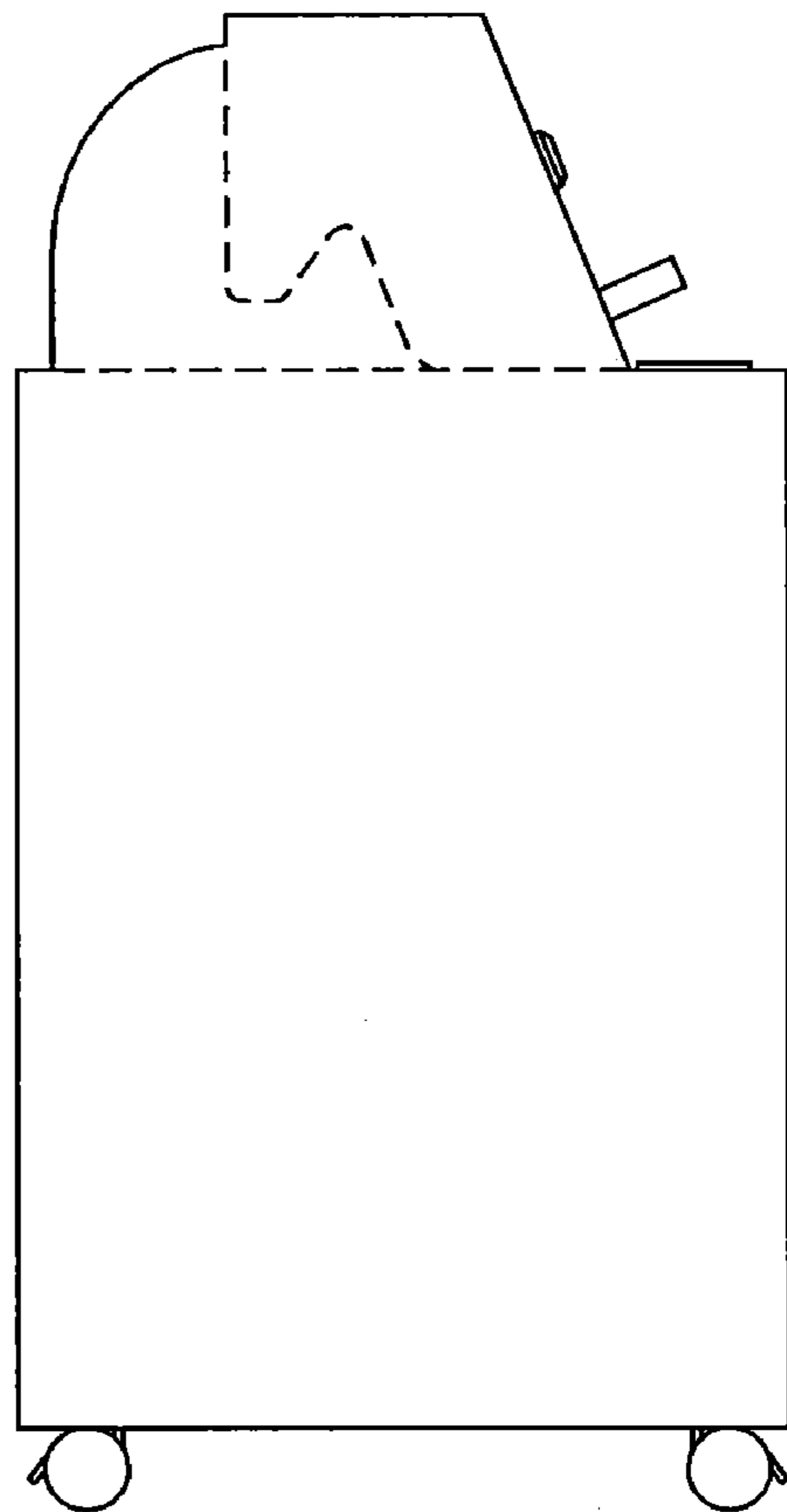

Fig. 6