



US00D614380S

(12) **United States Design Patent**
Lam et al.

(10) **Patent No.:** **US D614,380 S**

(45) **Date of Patent:** **** Apr. 27, 2010**

(54) **FIVE-PANEL FITTED HAT**

(76) Inventors: **Sam Lam**, 32 W. Linda Vista Ave.,
Alhambra, CA (US) 91801; **Vicky**
Hoang, 4700 Ivar Ave., Rosemead, CA
(US) 91770

(**) Term: **14 Years**

(21) Appl. No.: **29/337,549**

(22) Filed: **May 26, 2009**

(51) **LOC (9) Cl.** **02-03**

(52) **U.S. Cl.** **D2/882**

(58) **Field of Classification Search** D2/865,
D2/866, 878, 879, 880, 881, 882, 884, 886,
D2/888, 893; 2/171, 171.4, 171.5, 183, 184,
2/175.1, 195.1, 195.2, 195.3, 195.7, 209.12,
2/209.13, 209.3, 209.7

See application file for complete search history.

(56) **References Cited**

U.S. PATENT DOCUMENTS

D142,162	S *	8/1945	Dannenberg	D2/865
2,447,850	A *	8/1948	Feldman	2/195.2
D160,404	S *	10/1950	Levine	D2/866
D162,965	S *	4/1951	Krieger	D2/872
2,869,137	A *	1/1959	Scherz	2/195.4
2,908,012	A *	10/1959	Feldman	43/57.1
3,268,911	A *	8/1966	Cox	2/416
4,023,212	A *	5/1977	Huffman	2/195.2
D349,183	S *	8/1994	Harbison	D2/870
5,351,343	A *	10/1994	Harbison	2/423
D396,546	S *	8/1998	Marrs	D2/881
5,956,759	A *	9/1999	Benedict	2/7
D416,665	S *	11/1999	Jones	D2/874
D417,770	S *	12/1999	Greenwood	D2/882
D425,688	S *	5/2000	Richlin	D2/865
D427,751	S *	7/2000	Richlin	D2/866
6,502,246	B1 *	1/2003	Porter	2/195.3
D469,947	S *	2/2003	Park	D2/882

6,546,563	B2 *	4/2003	Young	2/181
6,560,785	B1 *	5/2003	Taguchi	2/171.1
D480,539	S *	10/2003	Yan	D2/882
D491,714	S *	6/2004	Upcott	D2/875
D517,285	S *	3/2006	Williams, Jr.	D2/872
7,047,571	B1 *	5/2006	Kelly	2/209.13
2002/0095715	A1 *	7/2002	Hong	2/209.11

OTHER PUBLICATIONS

Diamond Supply Co. 5-Panel Caps, as shown on www.individualsole.com, posted Jul. 18, 2008 (2 pages).*

Kangol X Staple Pigeon Sunhat, as shown on http://stapledesign.com, posted Sep. 16, 2009 (6 pages).*

Supreme s/s 2009 5 Panel Cap, as shown on www.SwaggerDap.com, posted May 12, 2009 (13 pages). Refer to pp. 1-3.*

* cited by examiner

Primary Examiner—Elizabeth A Albert

Assistant Examiner—Karen E Eldridge Powers

(57) **CLAIM**

The ornamental design for a five-panel fitted hat, as shown and described.

DESCRIPTION

FIG. 1 is a top, front and right-side perspective view of a five-panel fitted hat embodying our new design;

FIG. 2 is a front elevational view thereof;

FIG. 3 is a rear elevational view thereof;

FIG. 4 is a right-side elevational view thereof; the left-side elevational view being a mirror image;

FIG. 5 is a top plan view thereof; and,

FIG. 6 is a bottom plan view thereof.

The stippled pattern shown intermittently on the surfaces of the claimed design represents the texture of fabric and is understood to be applied to the entire surface of the claimed design upon which the stippling occurs.

1 Claim, 2 Drawing Sheets

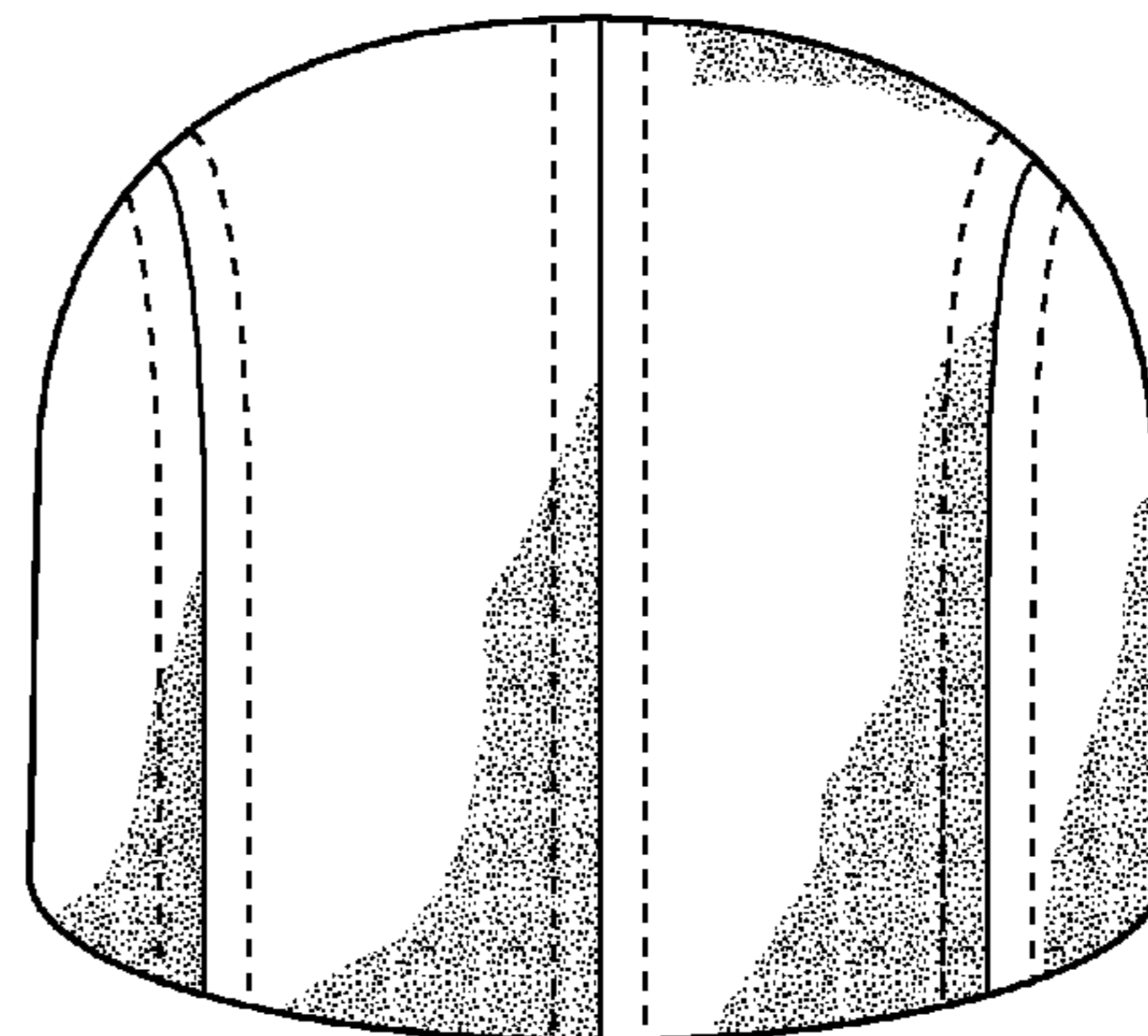
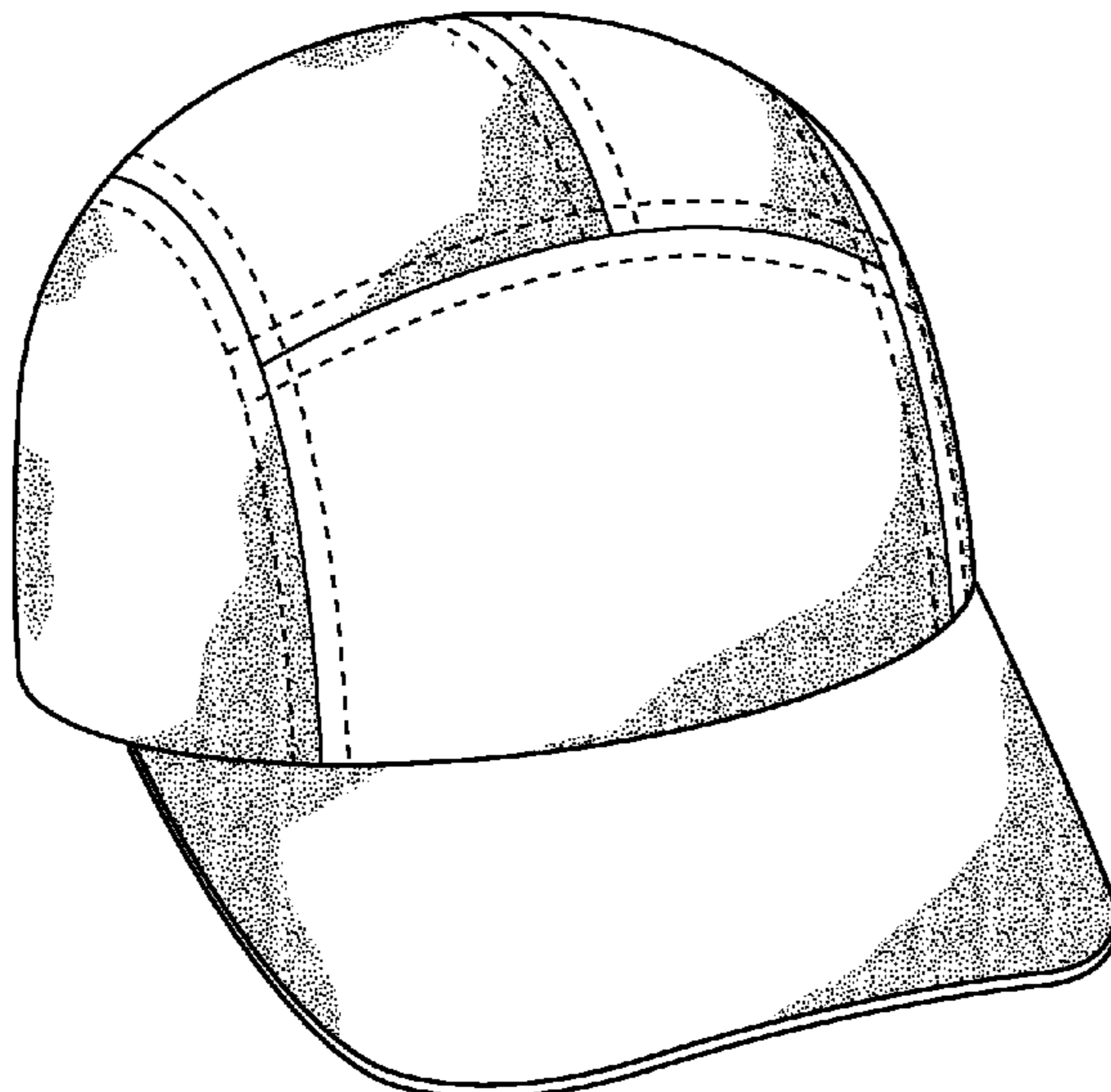

FIG. 1

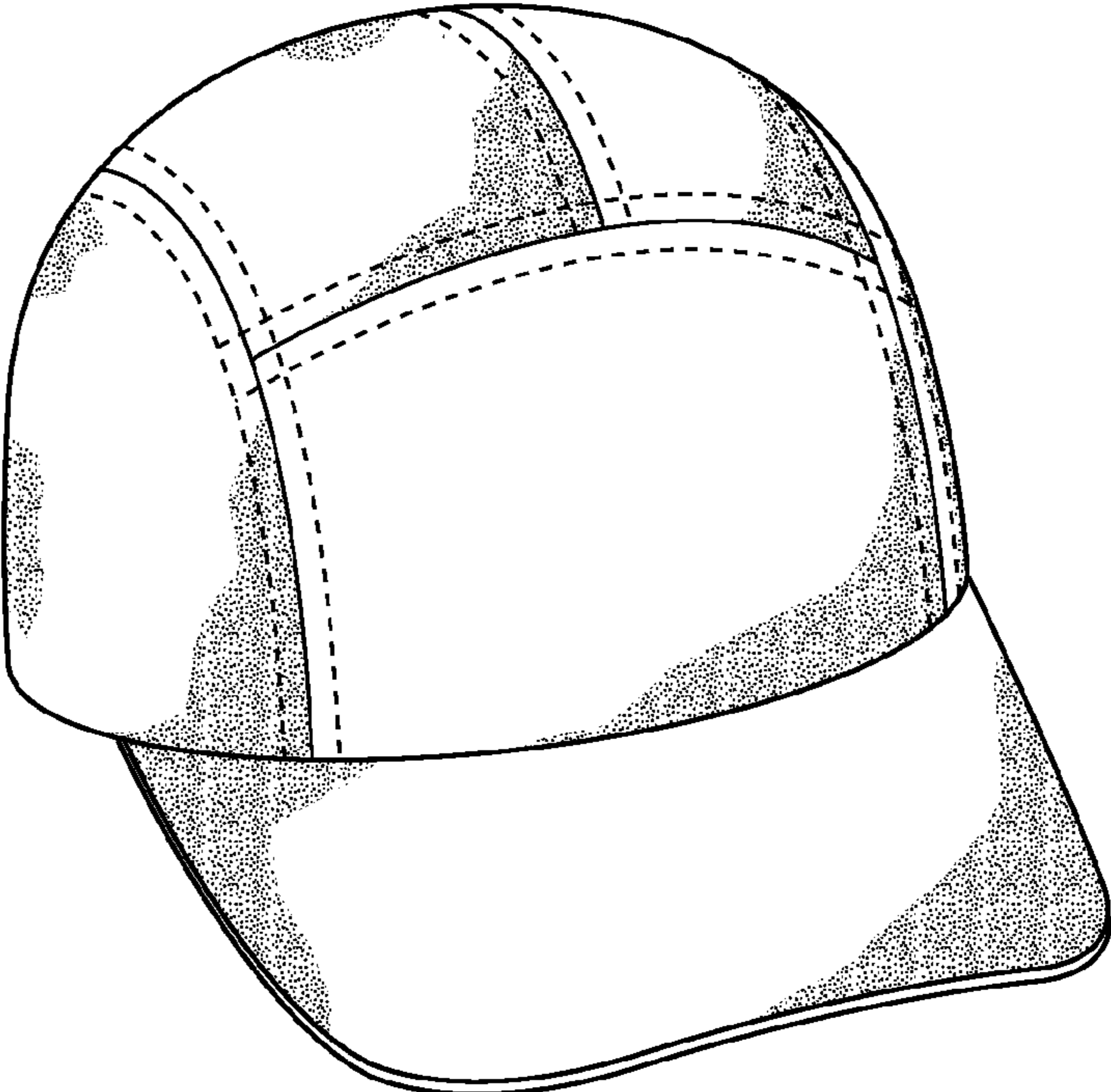

FIG. 2

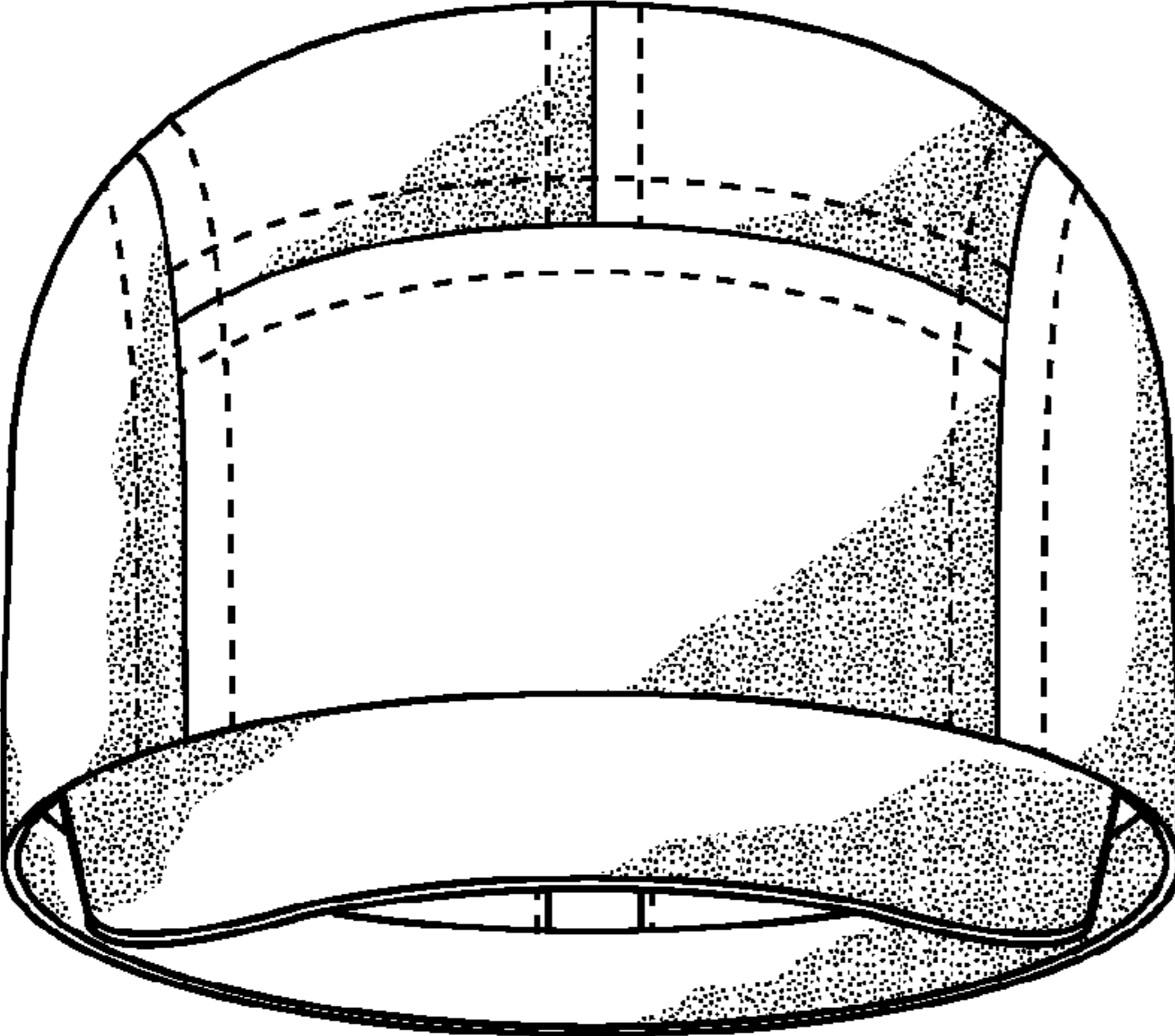
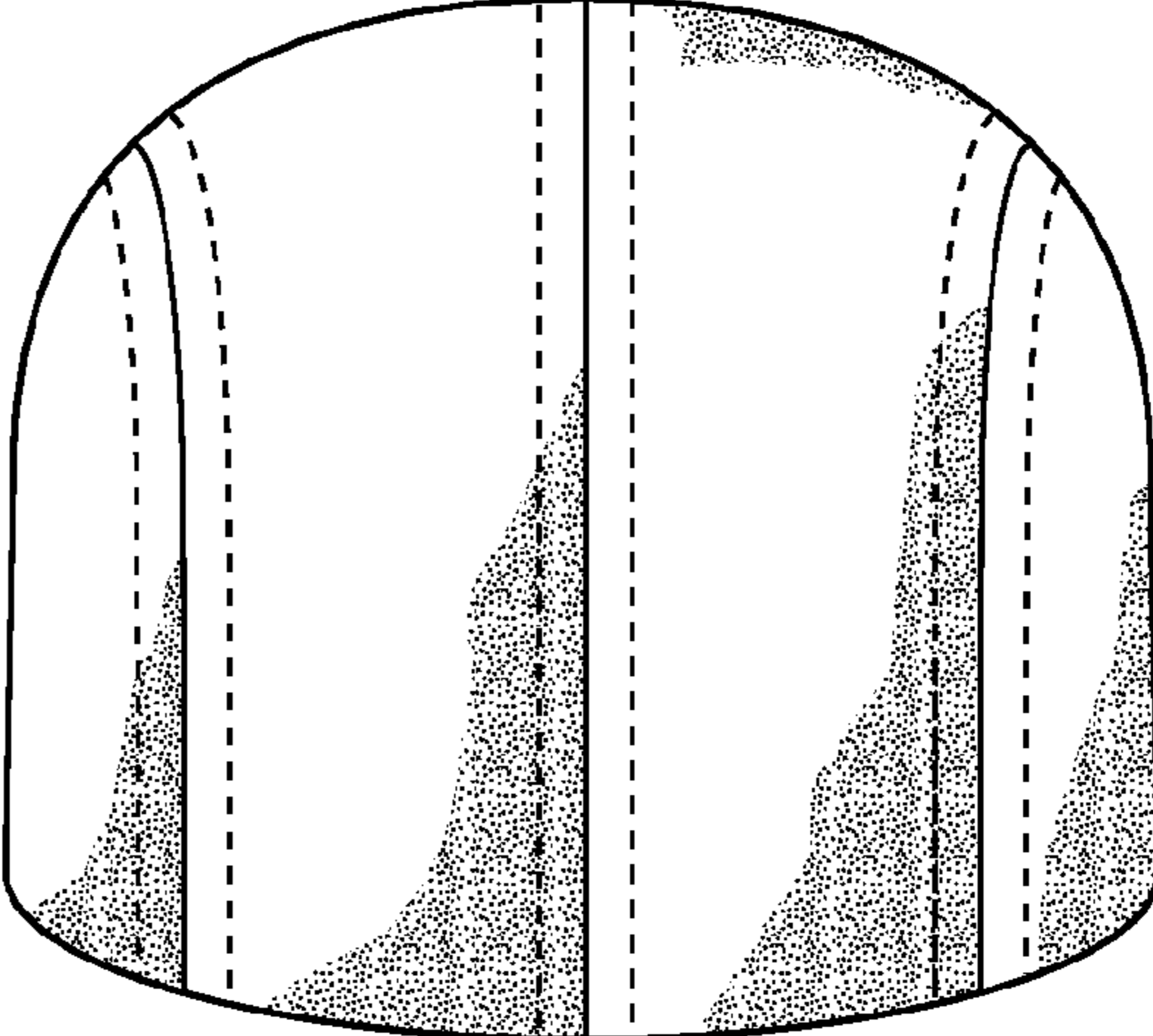

FIG. 3



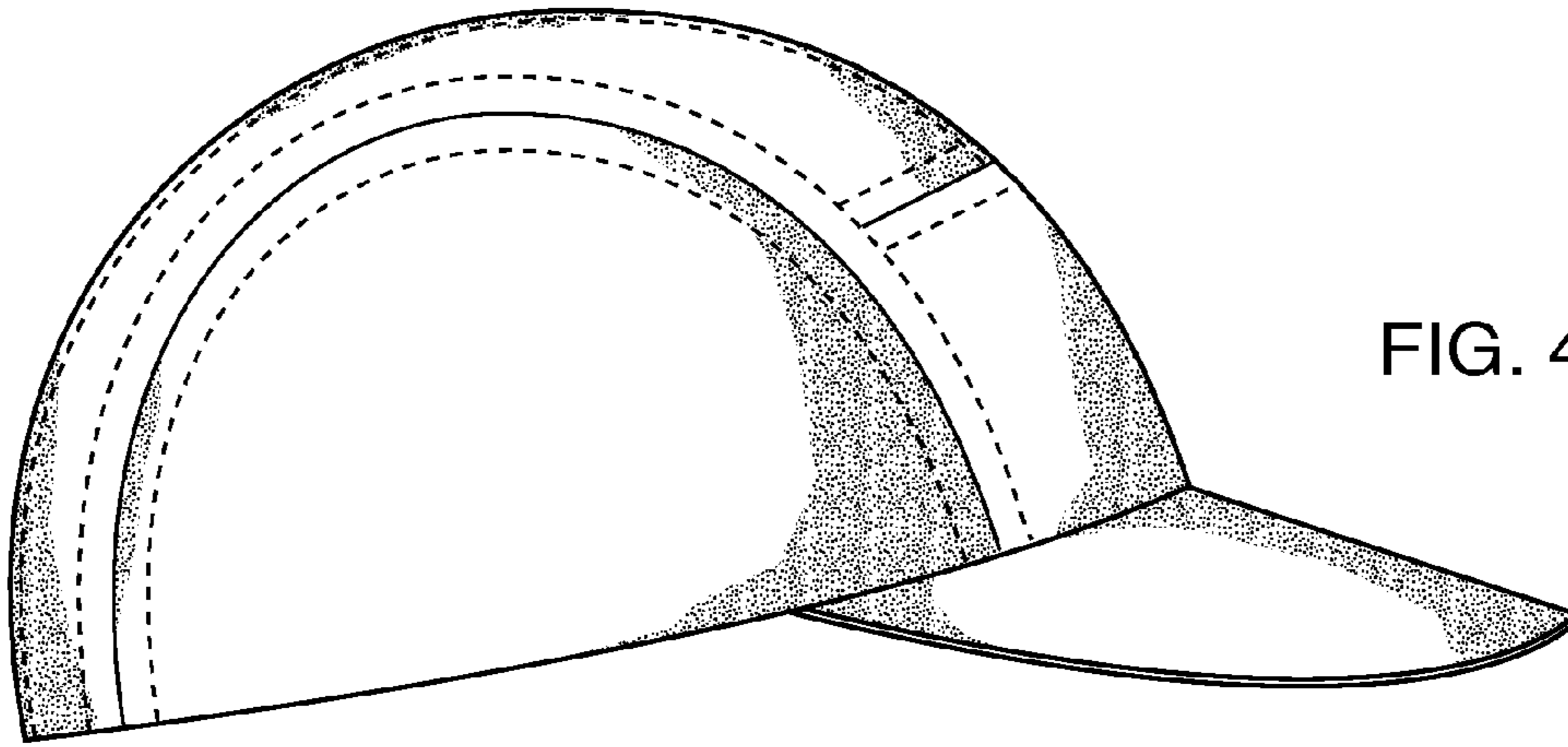

FIG. 4

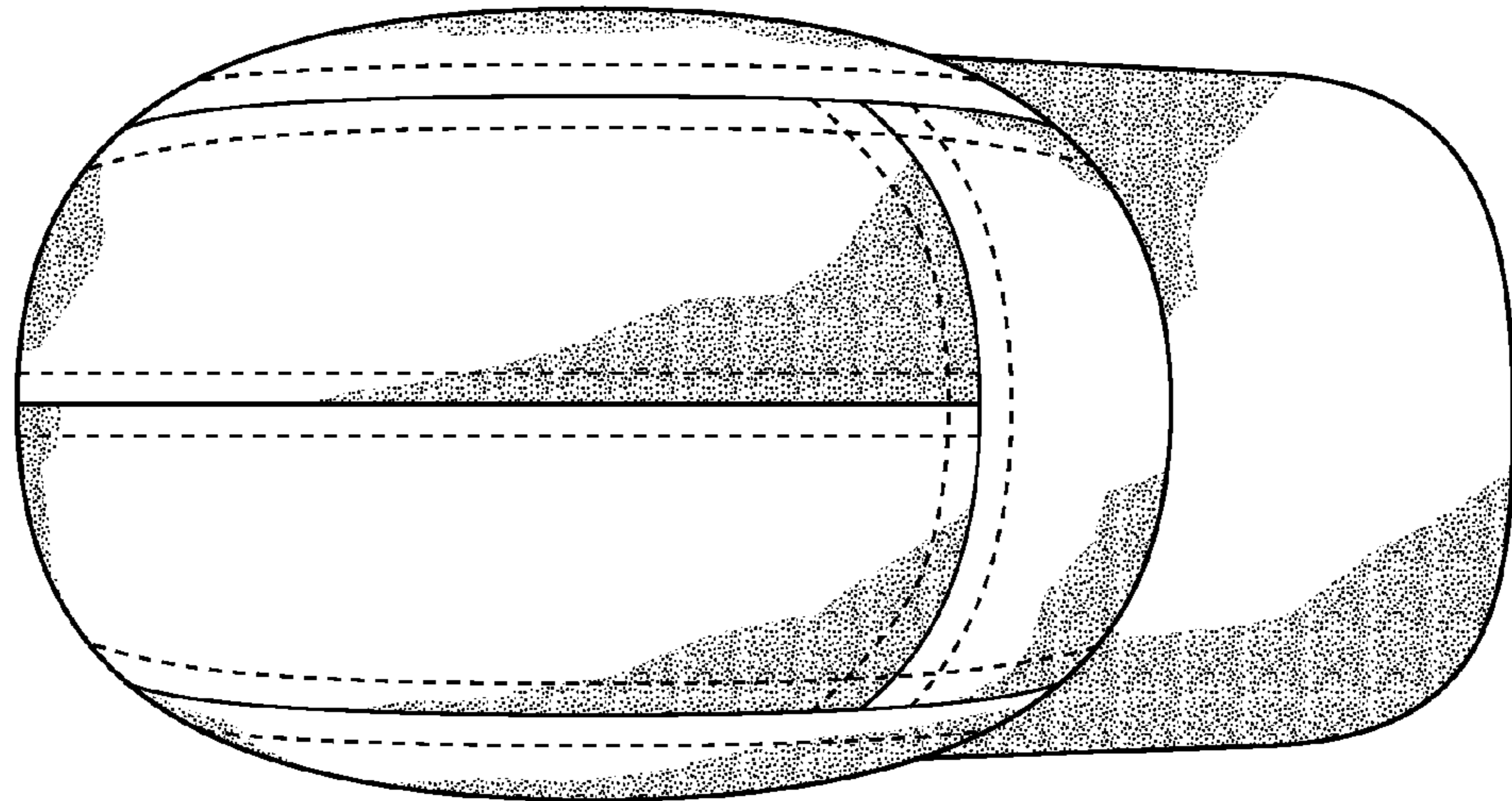

FIG. 5

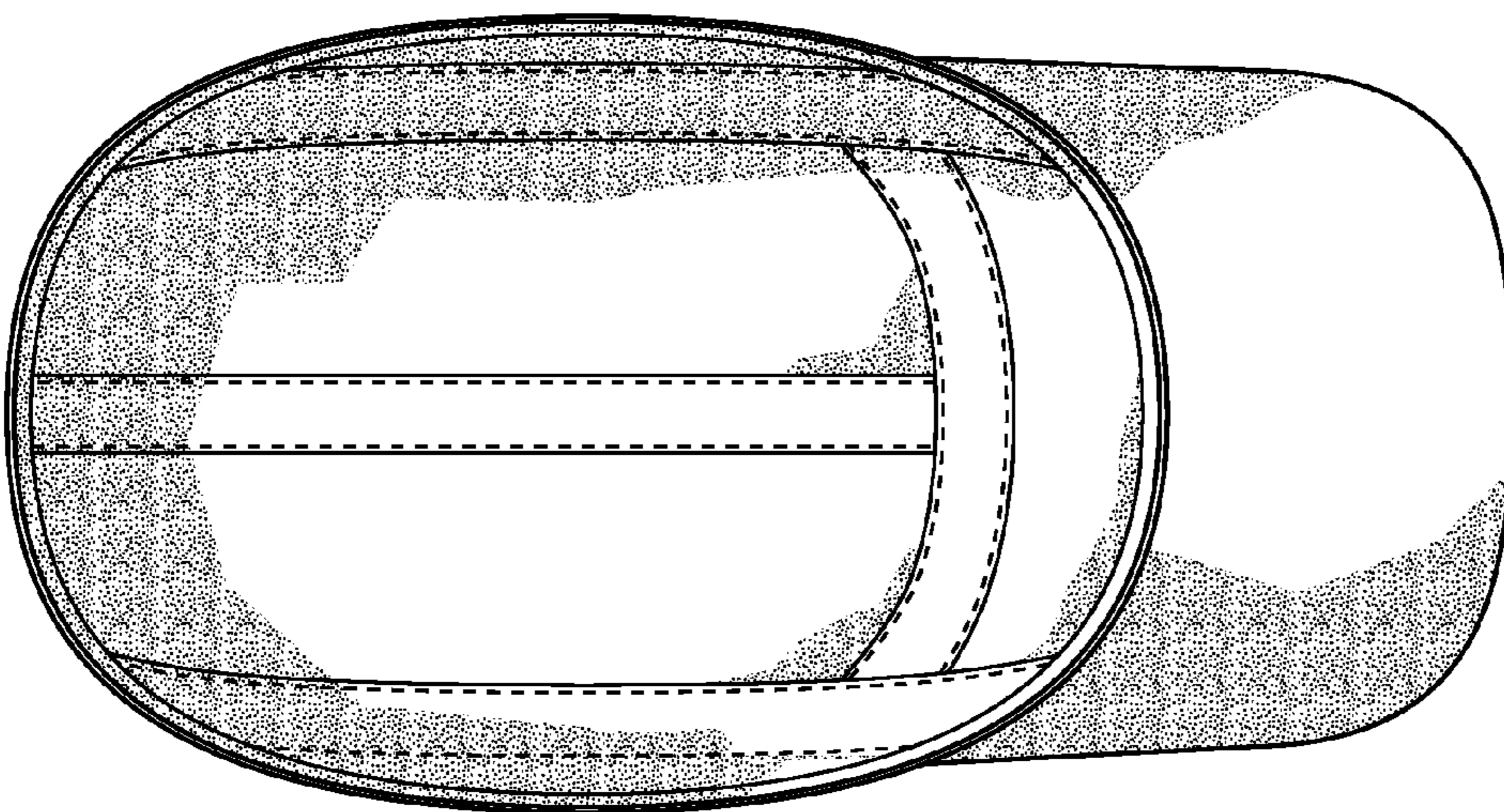

FIG. 6