



US00D614309S

(12) **United States Design Patent**
Wu

(10) **Patent No.:** **US D614,309 S**
(45) **Date of Patent:** **** Apr. 20, 2010**

(54) **CONTROL DEVICE**

D547,457 S * 7/2007 Wu D24/215
D585,559 S * 1/2009 Wu D24/215

(75) Inventor: **Wei Wu**, Zhejiang Province (CN)

* cited by examiner

(73) Assignee: **Zhejiang Lover Health Science and Technology Development Co., Ltd.**, Zhejiang Province (CN)

Primary Examiner—Cathron C Brooks
Assistant Examiner—Melanie Levy

(**) Term: **14 Years**

(57) **CLAIM**

(21) Appl. No.: **29/302,320**

The ornamental design for a control device, as shown and described.

(22) Filed: **Jan. 15, 2008**

DESCRIPTION

(51) **LOC (9) Cl.** **28-03**

(52) **U.S. Cl.** **D24/215**

(58) **Field of Classification Search** D24/211–215,
D24/200, 143; 601/46, 101, 64, 87, 84, 80,
601/70, 85, 78, 67, 122, 128, 57, 94, 69,
601/127, 79, 72, DIG. 14, DIG. 16; 600/38,
600/39; D13/168, 169, 170, 174; D14/218,
D14/137, 159, 207, 204

FIG. 1 is a front elevational view of a control device showing my new design;

FIG. 2 is a rear elevational view thereof;

FIG. 3 is a left side view thereof;

FIG. 4 is a right side view thereof;

FIG. 5 is a top plan view thereof;

FIG. 6 is a bottom plan view thereof; and,

FIG. 7 is a perspective view thereof.

See application file for complete search history.

The broken lines shown form no part of the claimed design.

The claimed control device is used for controlling sex toy.

(56) **References Cited**

U.S. PATENT DOCUMENTS

D546,468 S * 7/2007 Wu D24/215
D546,470 S * 7/2007 Wu D24/215

1 Claim, 7 Drawing Sheets

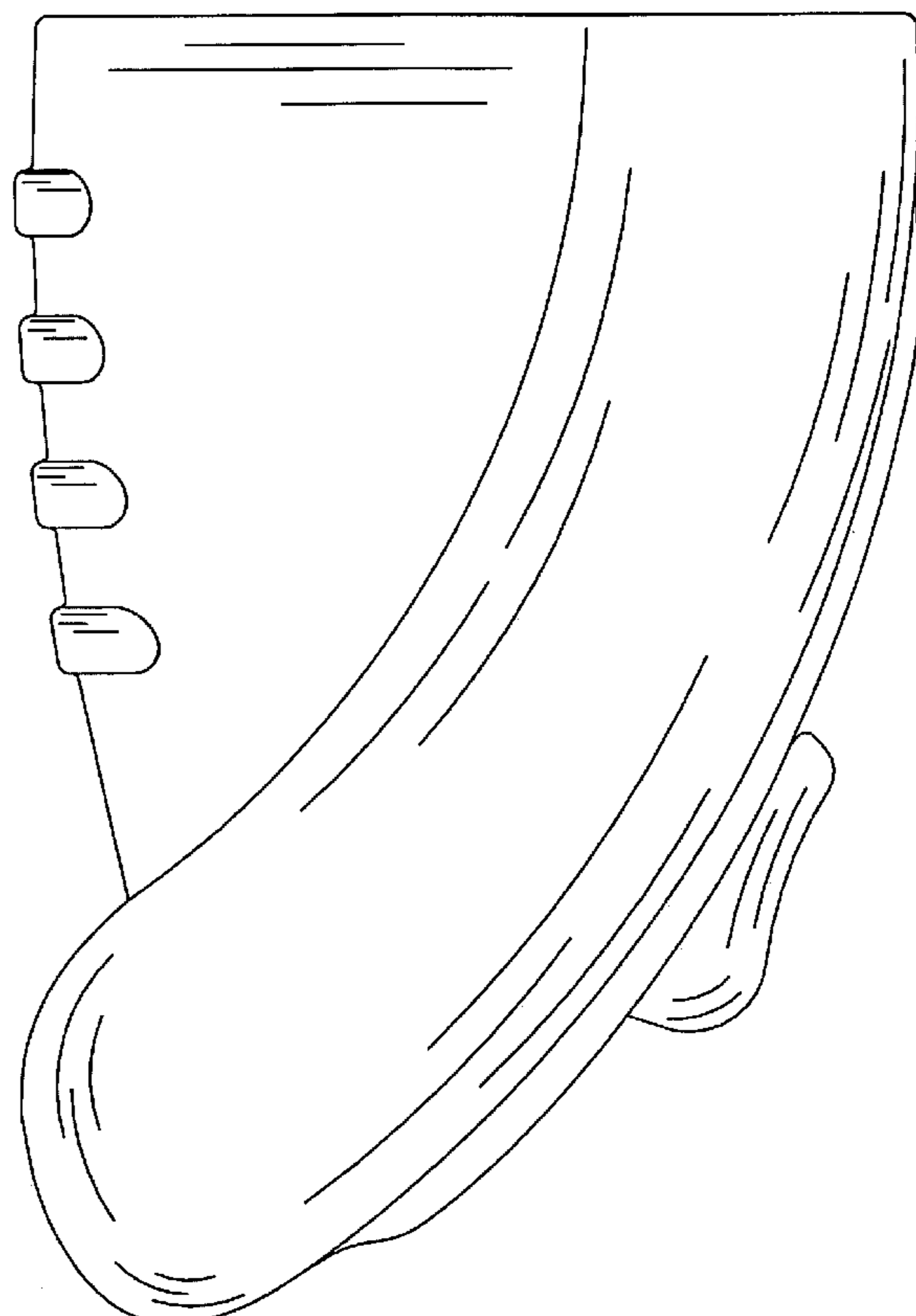
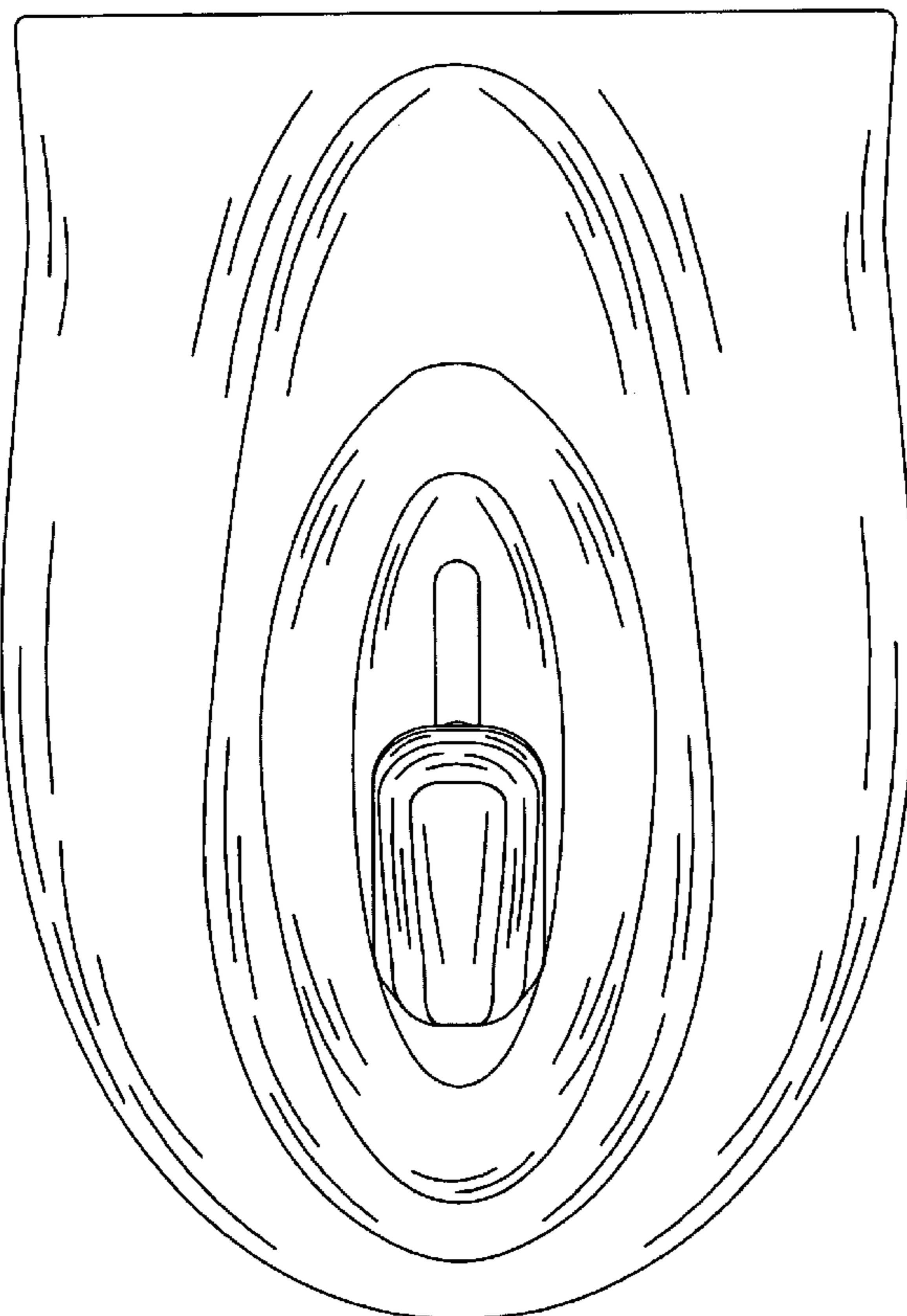

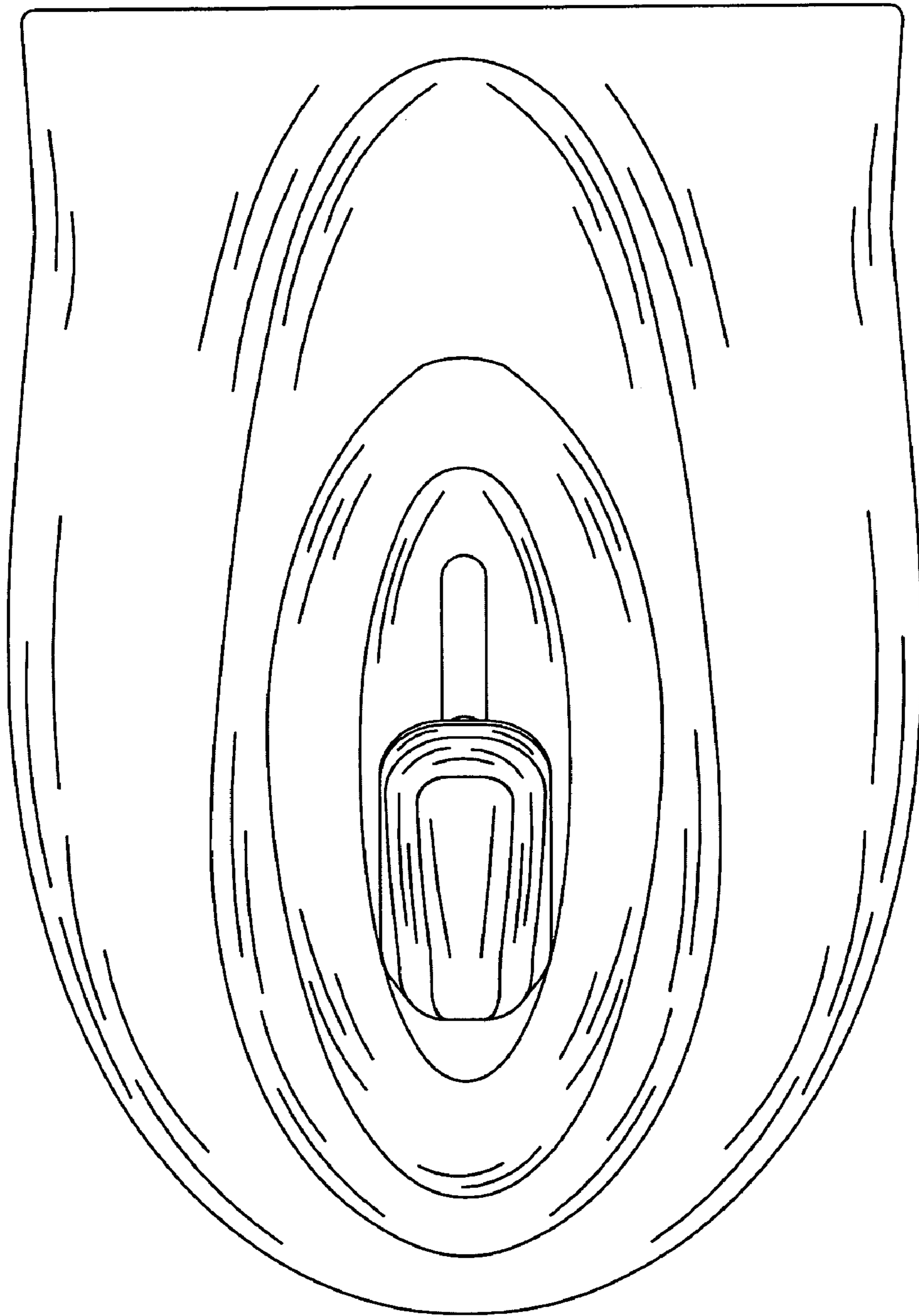

FIG. 1

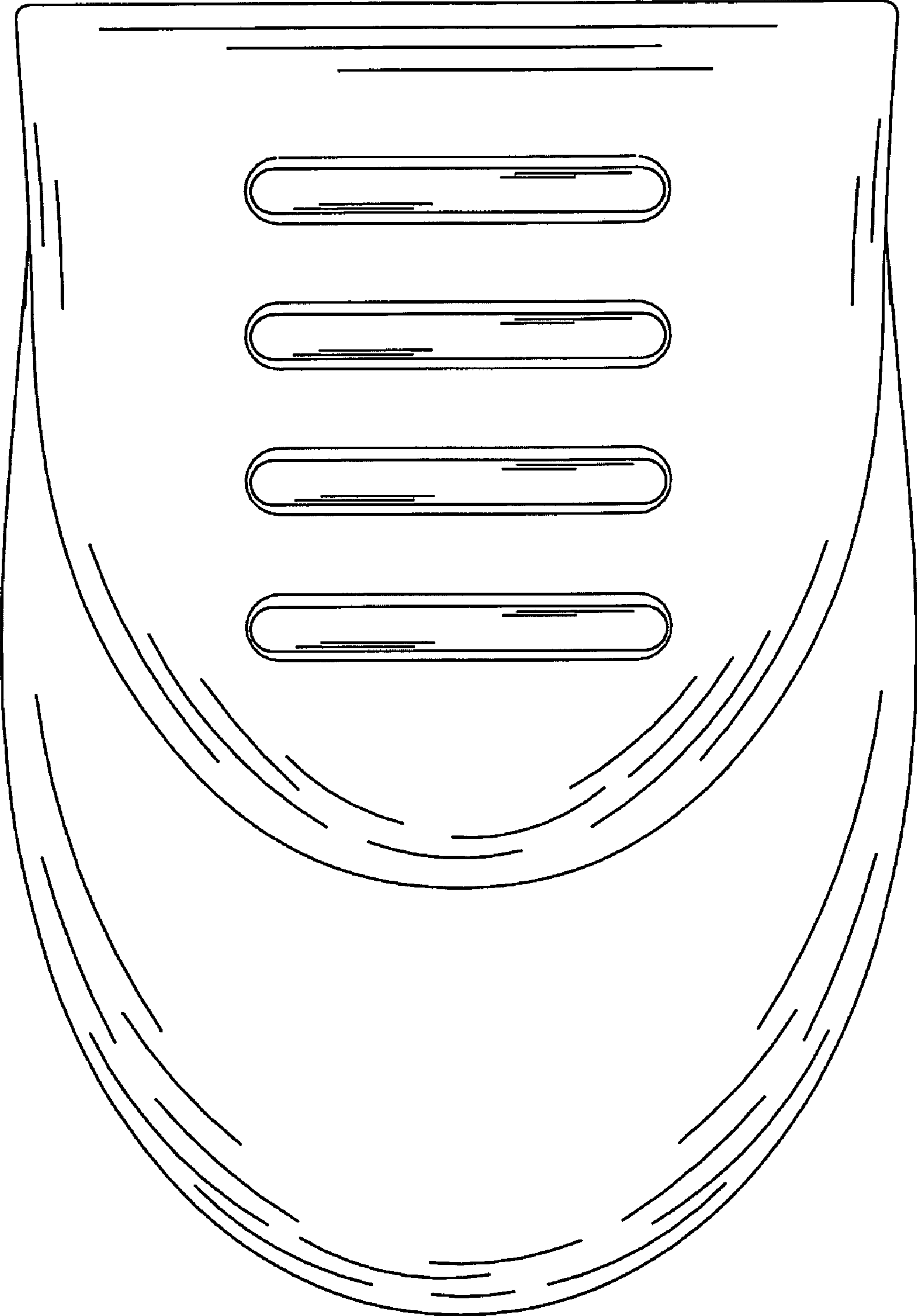

FIG. 2

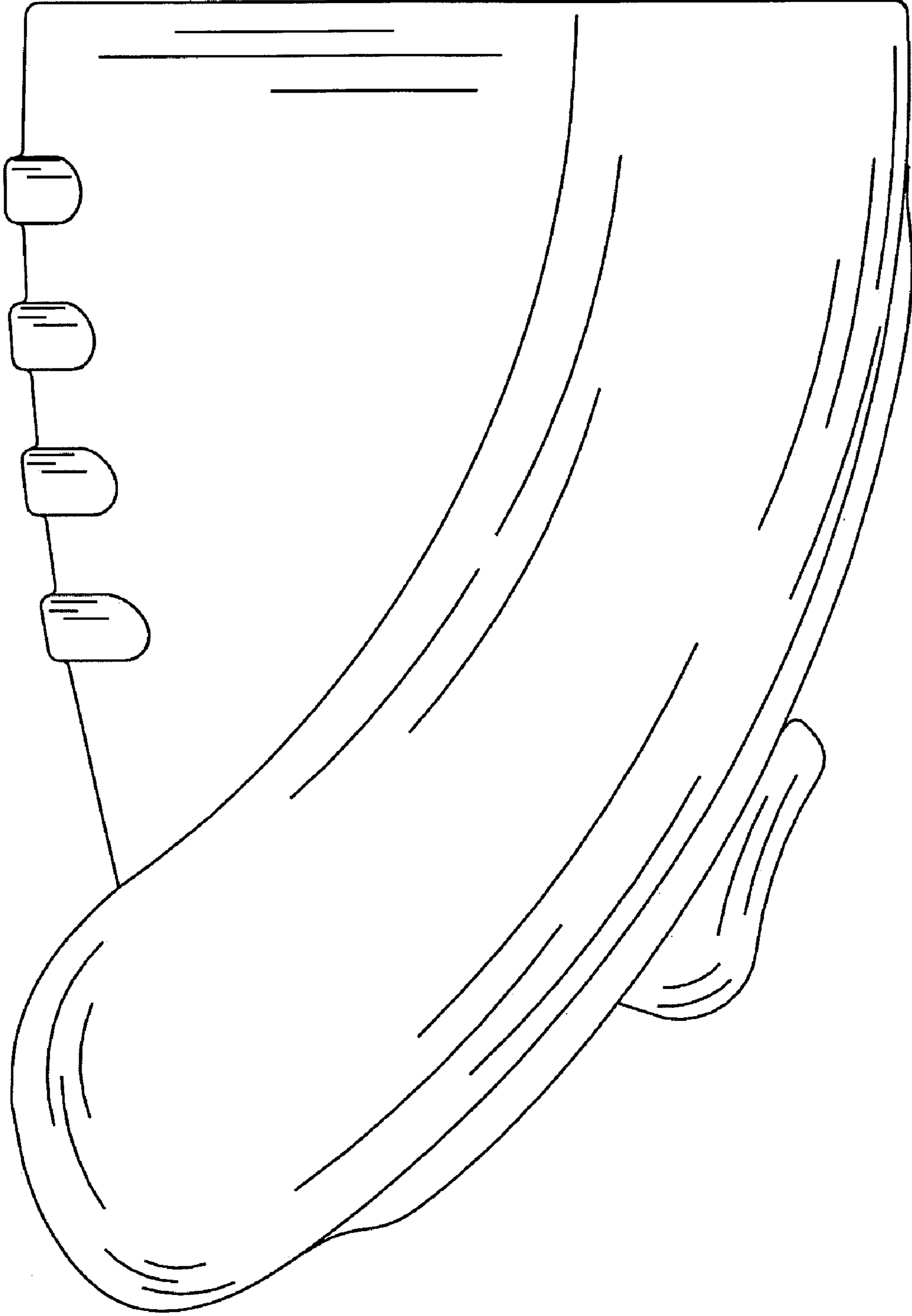

FIG. 3

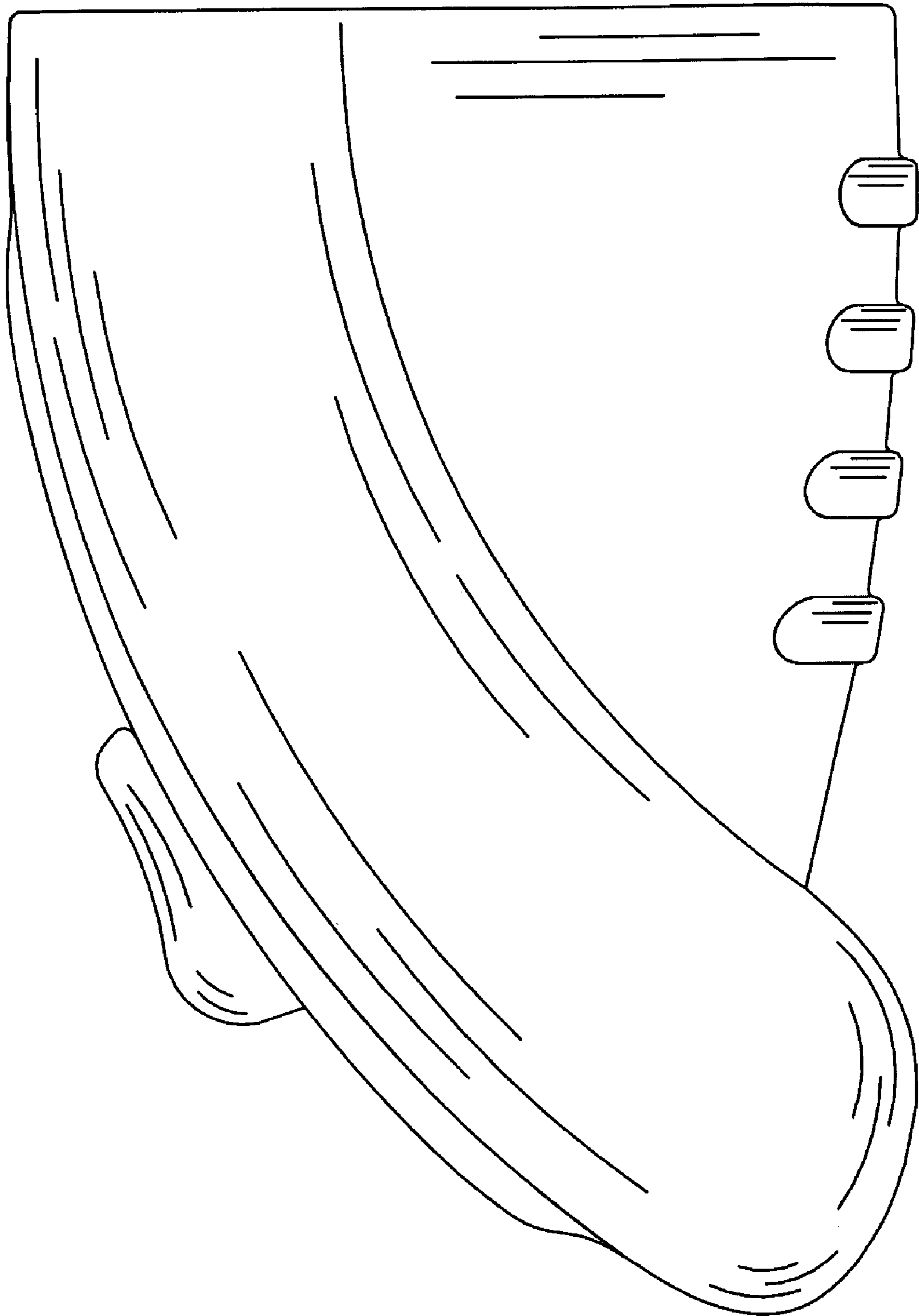

FIG. 4

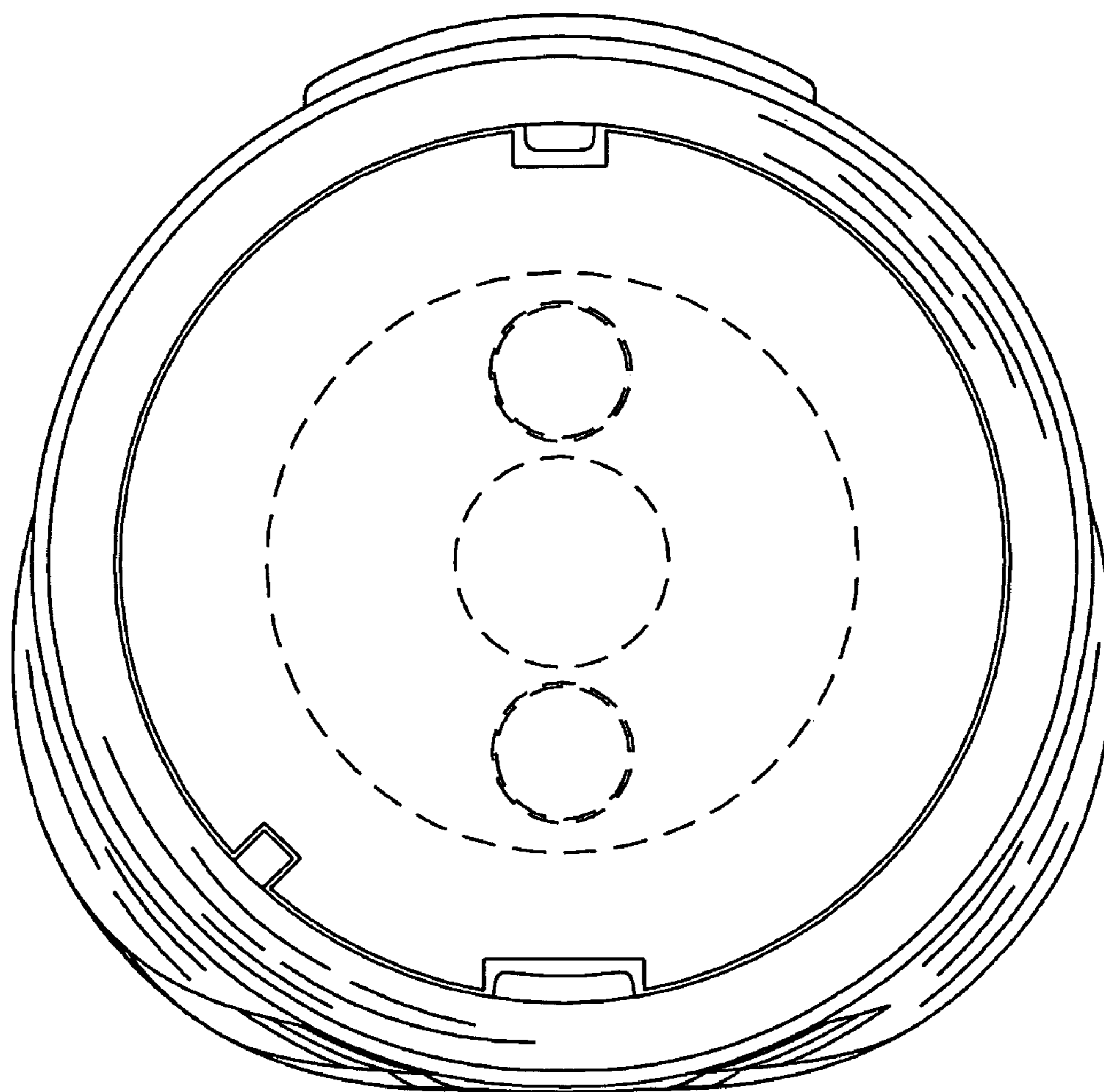

FIG. 5

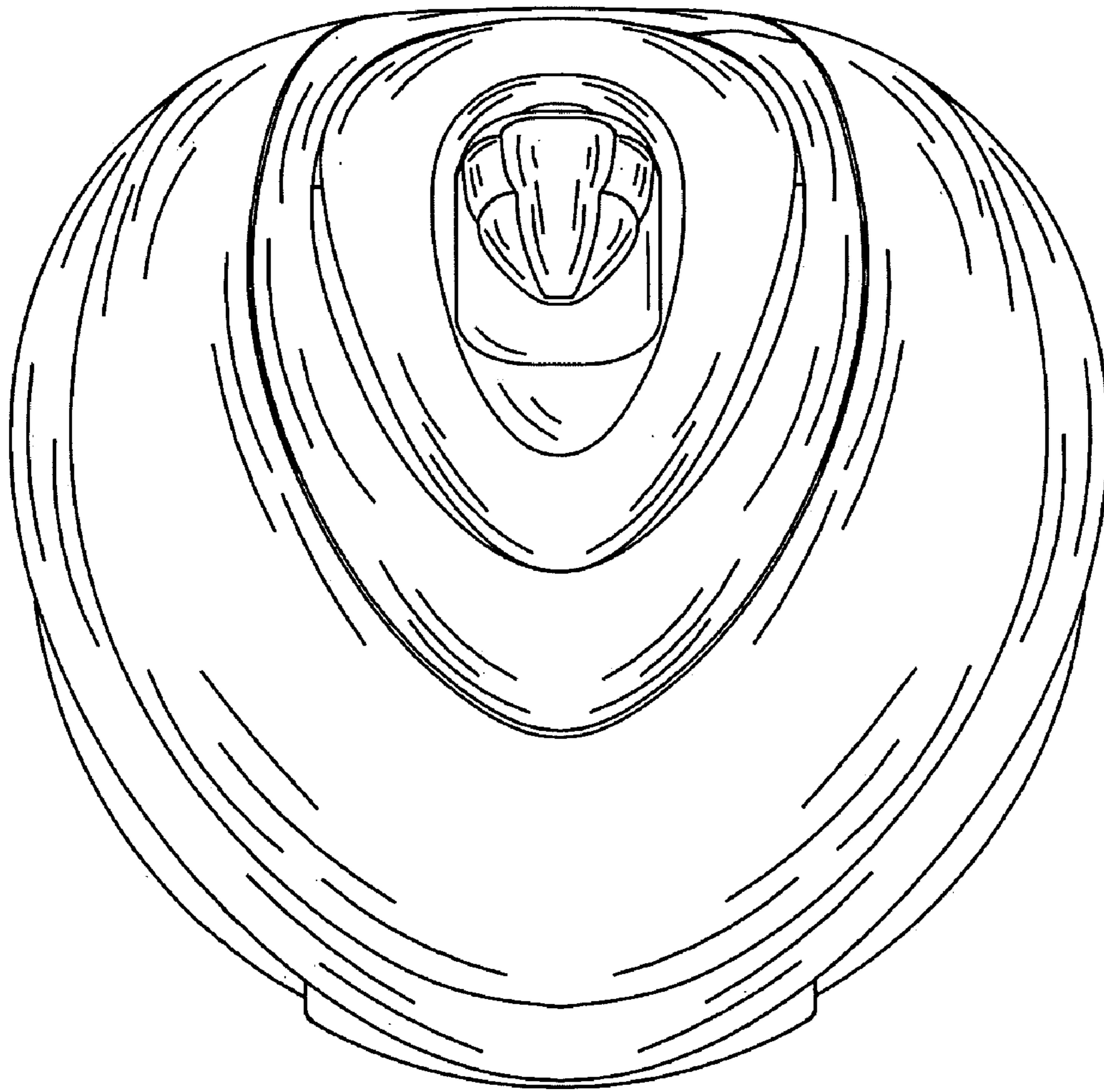

FIG. 6

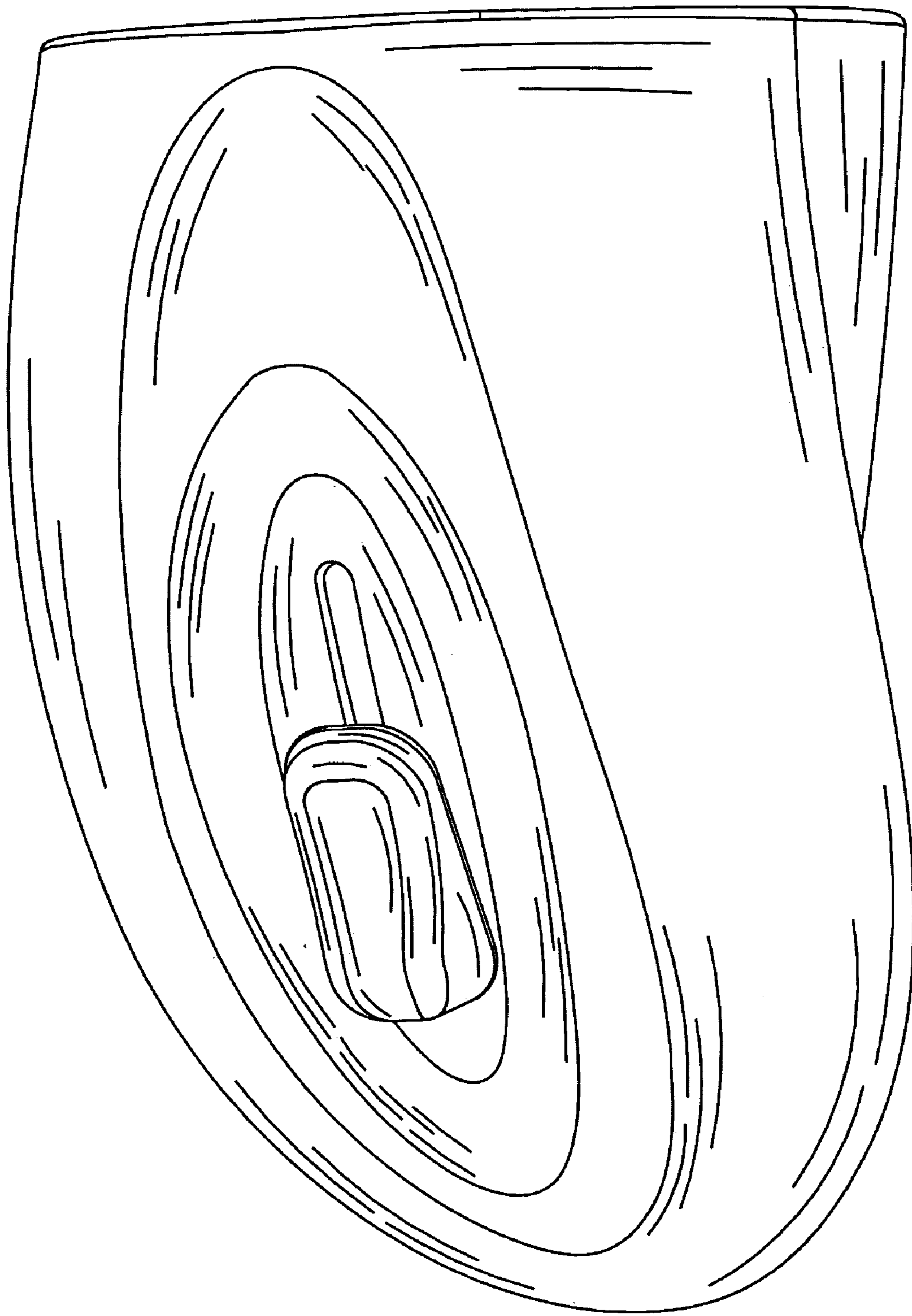

FIG. 7