



US00D614262S

(12) **United States Design Patent**  
**Roy**

(10) **Patent No.:** **US D614,262 S**  
(45) **Date of Patent:** **\*\* Apr. 20, 2010**

(54) **HAND SPRAY**

(75) Inventor: **Annette Roy**, Duesseldorf (DE)

(73) Assignee: **Grohe AG**, Hemer (DE)

(\*\*) Term: **14 Years**

(21) Appl. No.: **29/330,391**

(22) Filed: **Jan. 6, 2009**

(30) **Foreign Application Priority Data**

Jul. 29, 2008 (EM) ..... 000978705-0003

(51) **LOC (9) Cl.** ..... **23-01**

(52) **U.S. Cl.** ..... **D23/223**

(58) **Field of Classification Search** ..... D23/213,  
D23/223, 229-230; 239/462, 394, 282-283  
See application file for complete search history.

(56) **References Cited**

**U.S. PATENT DOCUMENTS**

D405,158 S \* 2/1999 Hagen ..... D23/213

D470,219 S \* 2/2003 Schweitzer ..... D23/223

D579,516 S \* 10/2008 Hsu ..... D23/223

\* cited by examiner

*Primary Examiner*—Robin V Webster

(74) *Attorney, Agent, or Firm*—Muncy, Geissler, Olds &  
Lowe, PLLC

(57) **CLAIM**

The ornamental design of a hand spray, as shown and described.

**DESCRIPTION**

FIG. 1 is a perspective view of a hand spray according to a first embodiment of the present invention;

FIG. 2 is a left side elevational view of the hand spray of FIG. 1;

FIG. 3 is a right side elevational view of the hand spray of FIG. 1;

FIG. 4 is a rear elevational view of the hand spray of FIG. 1;

FIG. 5 is a front elevational view of the hand spray of FIG. 1;

FIG. 6 is a bottom plan view of the hand spray of FIG. 1;

FIG. 7 is a top plan view of the hand spray of FIG. 1;

FIG. 8 is a perspective view of a hand spray according to a second embodiment of the present invention;

FIG. 9 is a left side elevational view of the hand spray of FIG. 8;

FIG. 10 is a right side elevational view of the hand spray of FIG. 8;

FIG. 11 is a rear elevational view of the hand spray of FIG. 8;

FIG. 12 is a front elevational view of the hand spray of FIG. 8;

FIG. 13 is a bottom plan view of the hand spray of FIG. 8; and,

FIG. 14 is a top plan view of the hand spray of FIG. 8.

The dashed lines illustrate environment that does not form a part of the present invention, and no claim is made to the material illustrated with dashed lines.

**1 Claim, 12 Drawing Sheets**

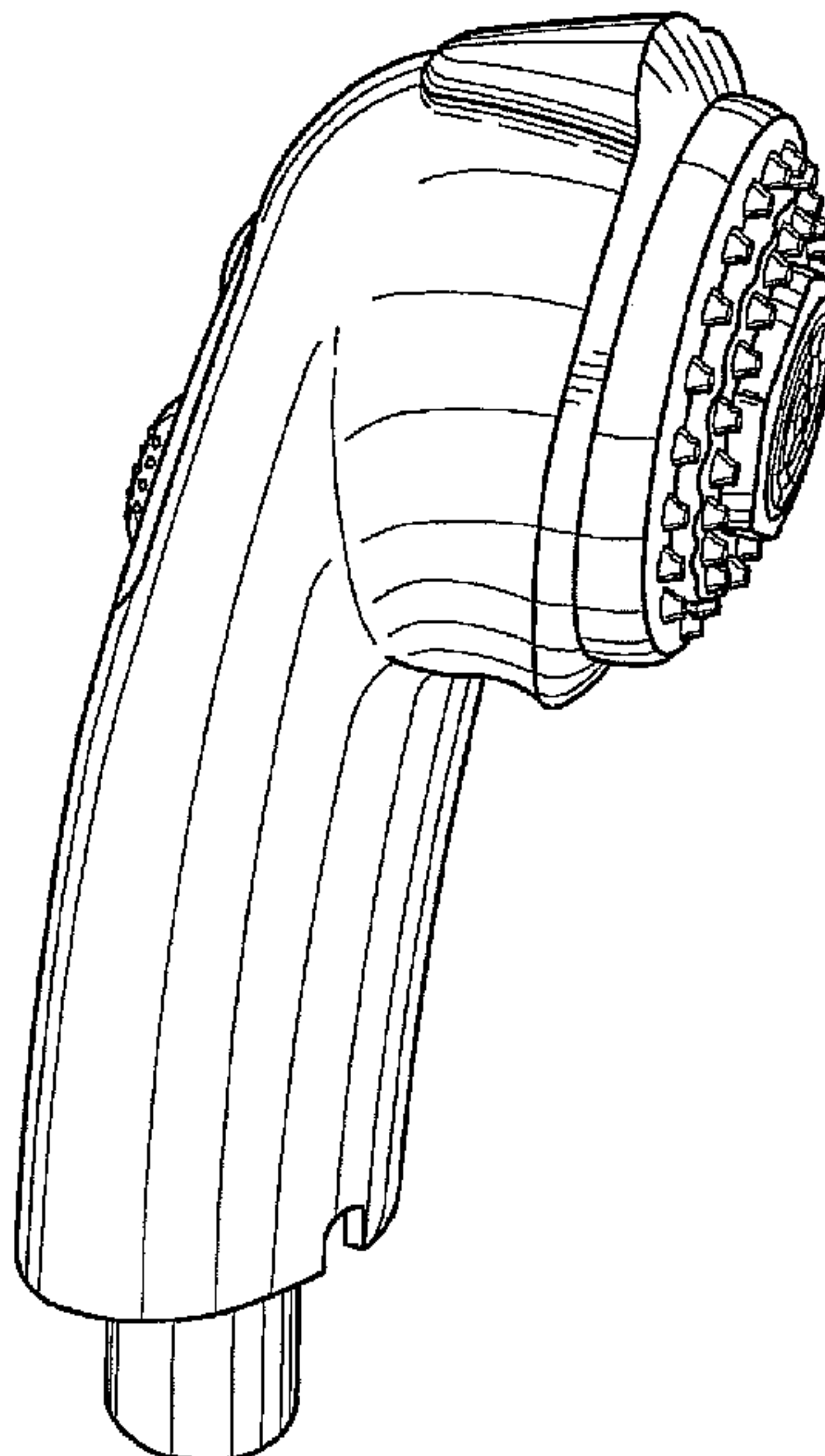

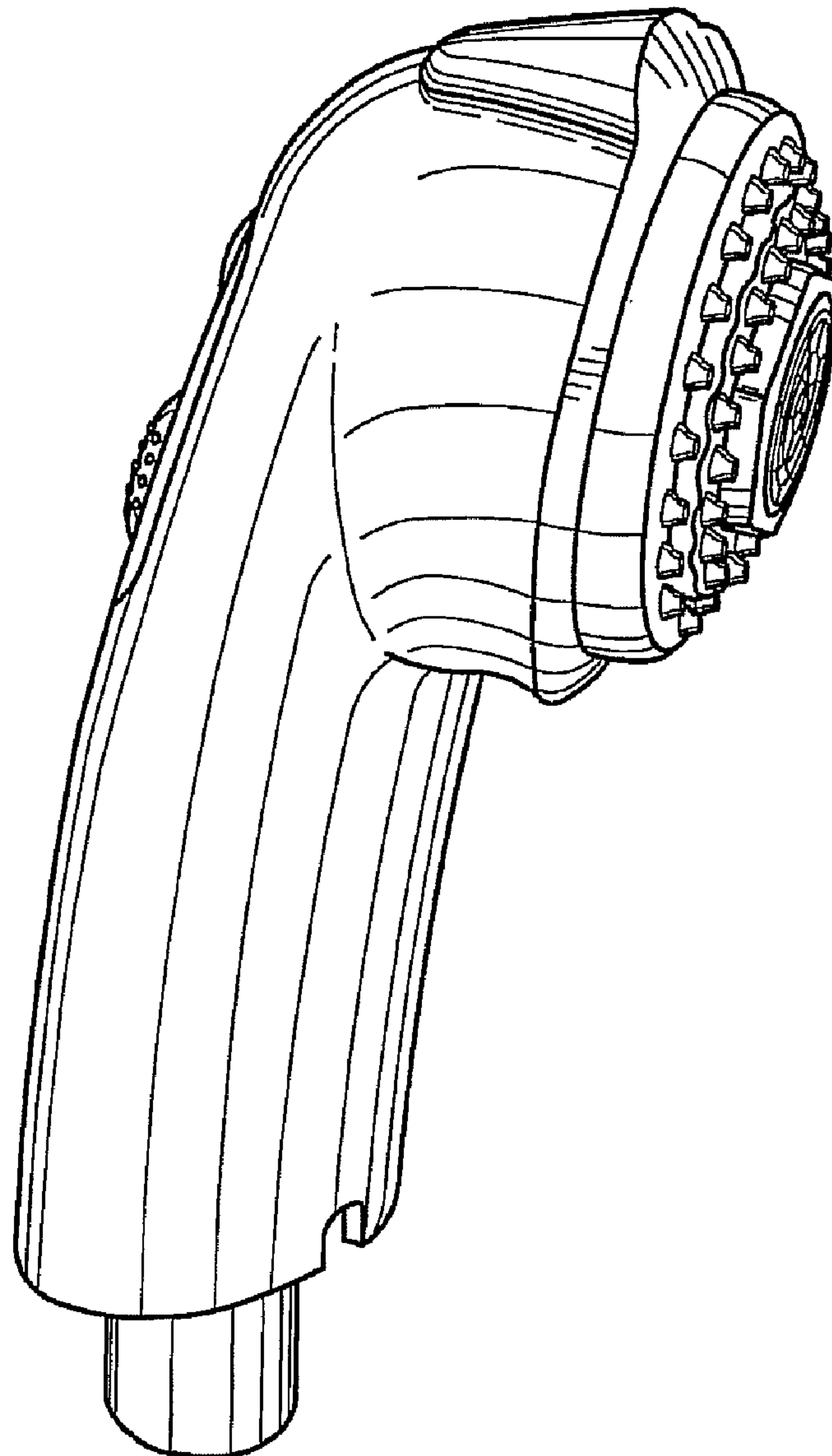

FIG. 1

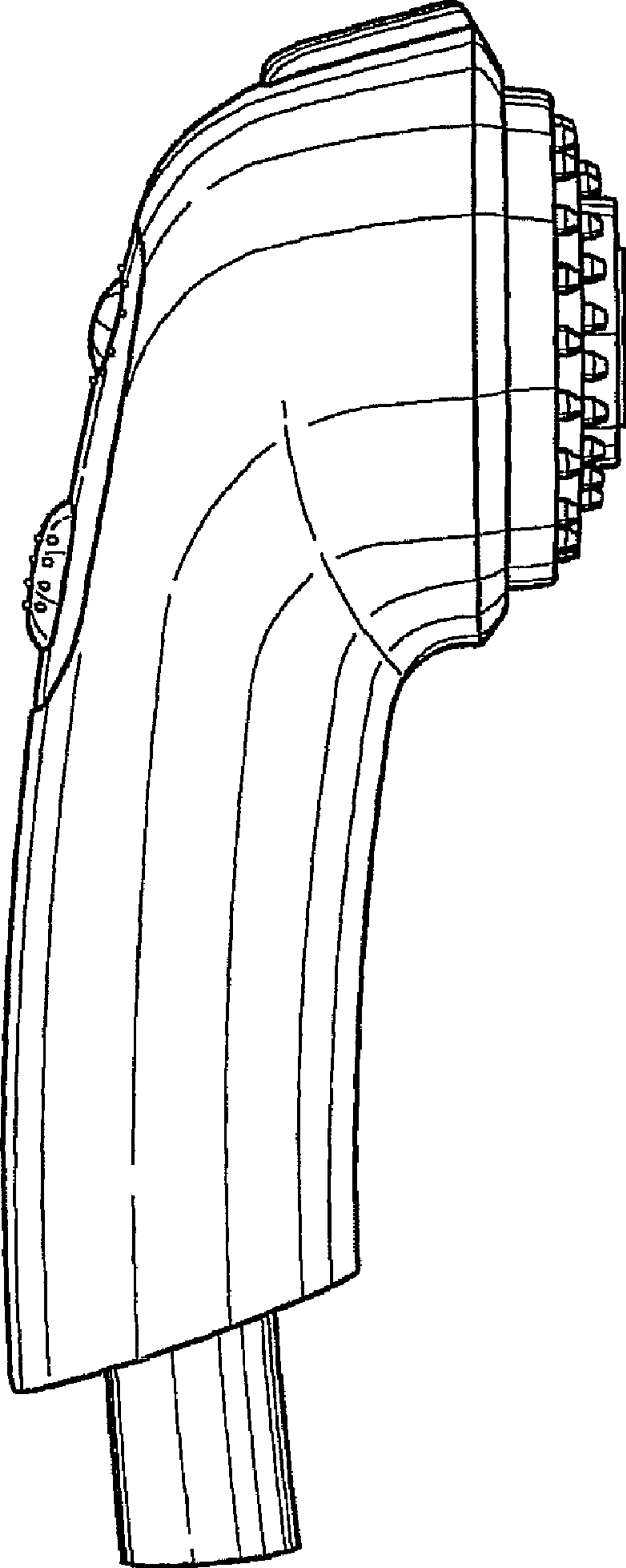

FIG. 2

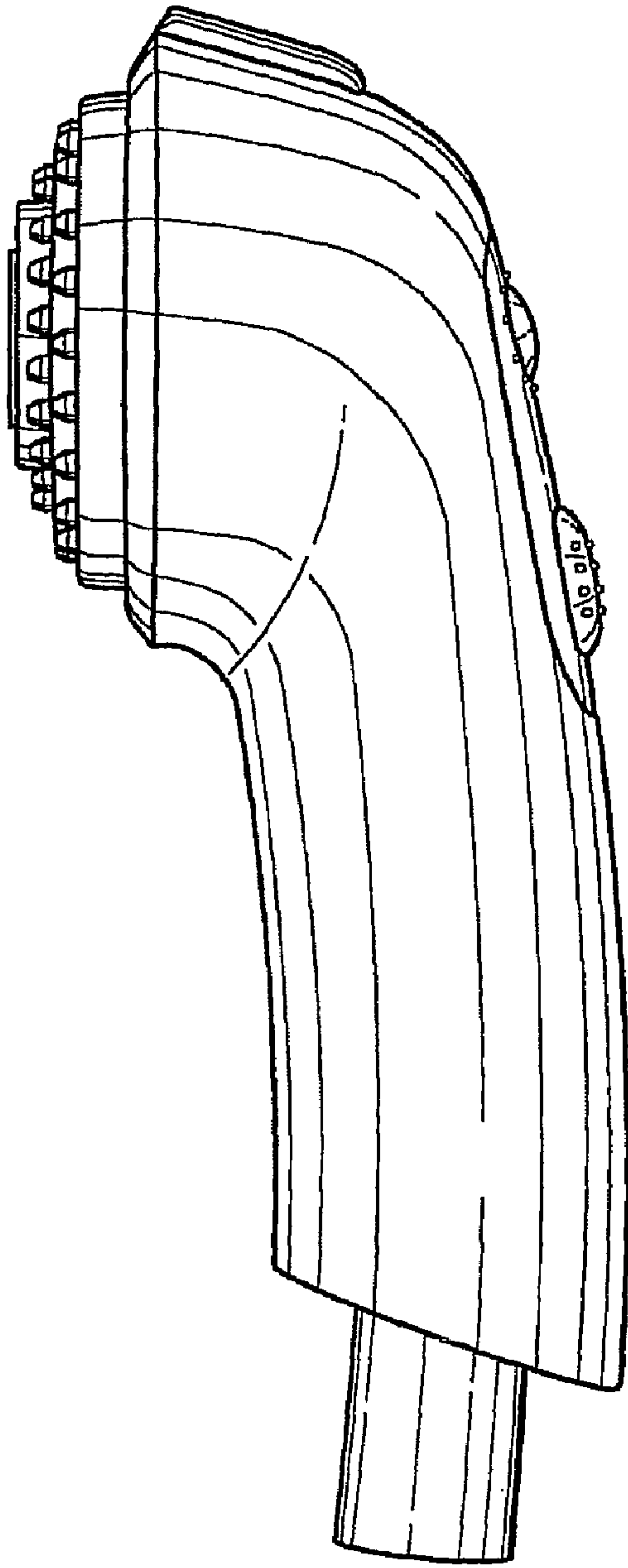
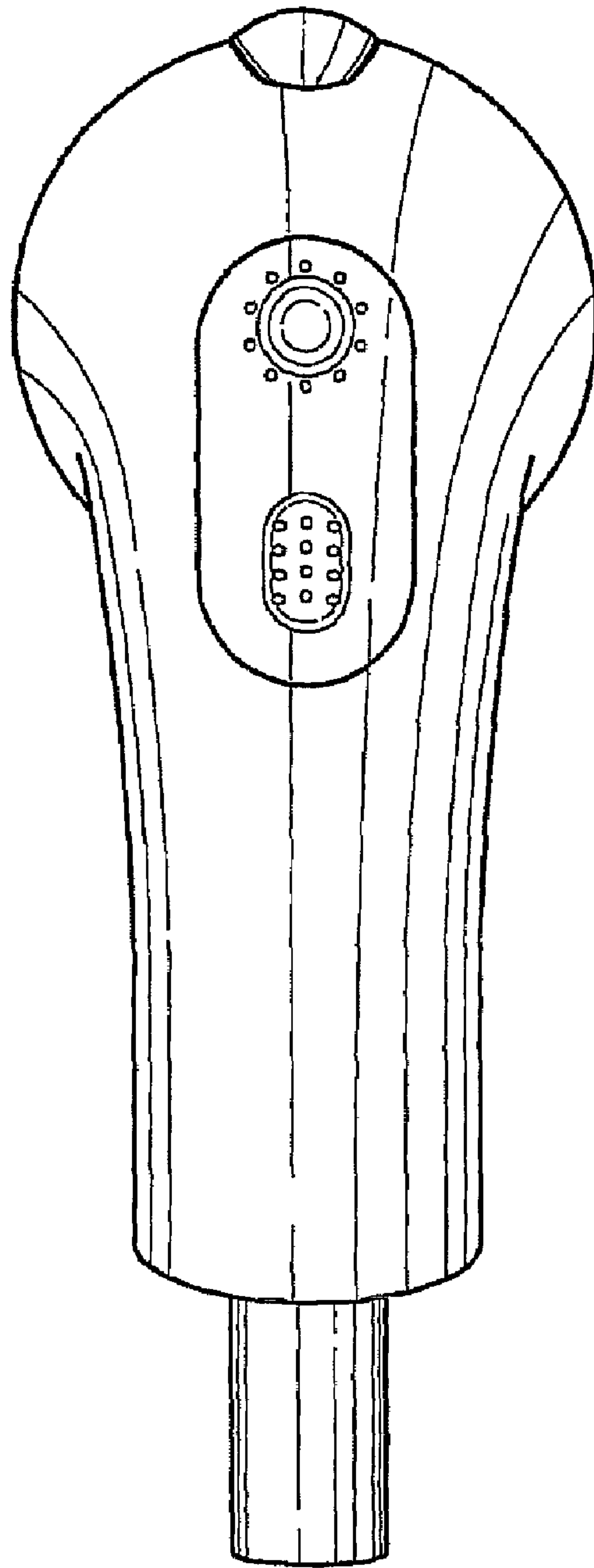
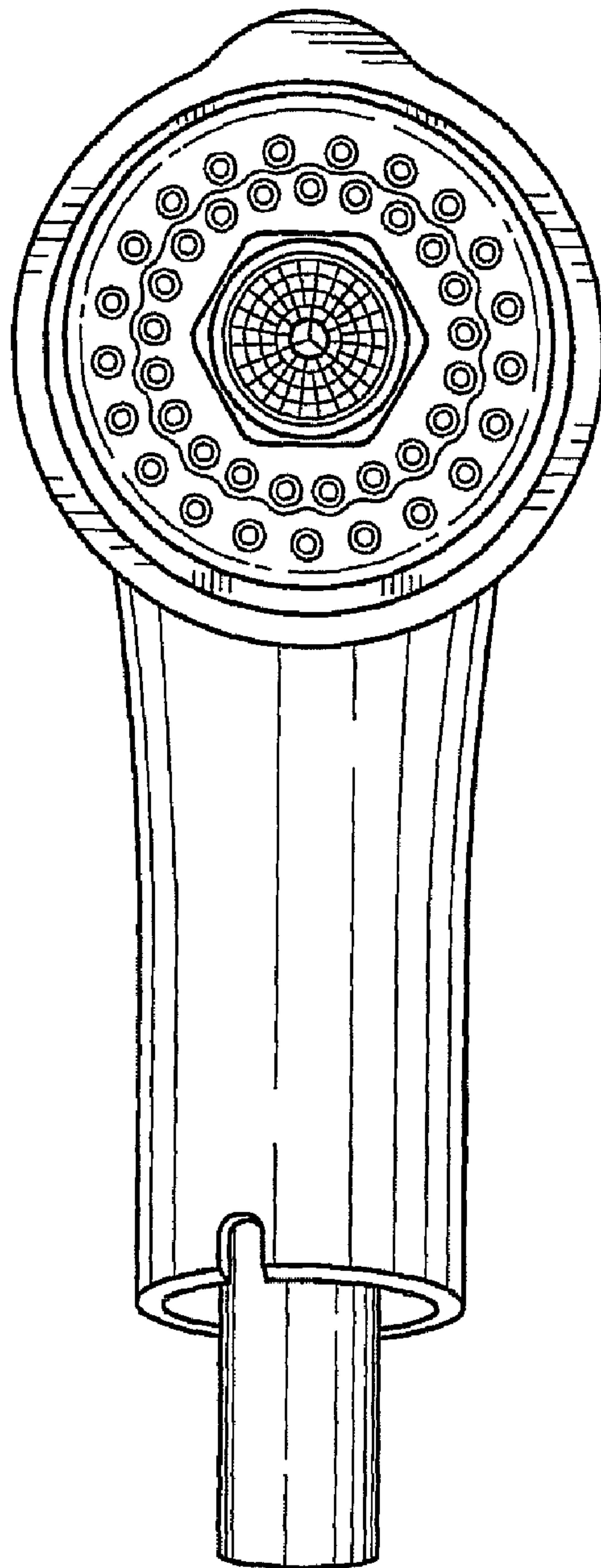

FIG. 3



**FIG. 4**



**FIG. 5**

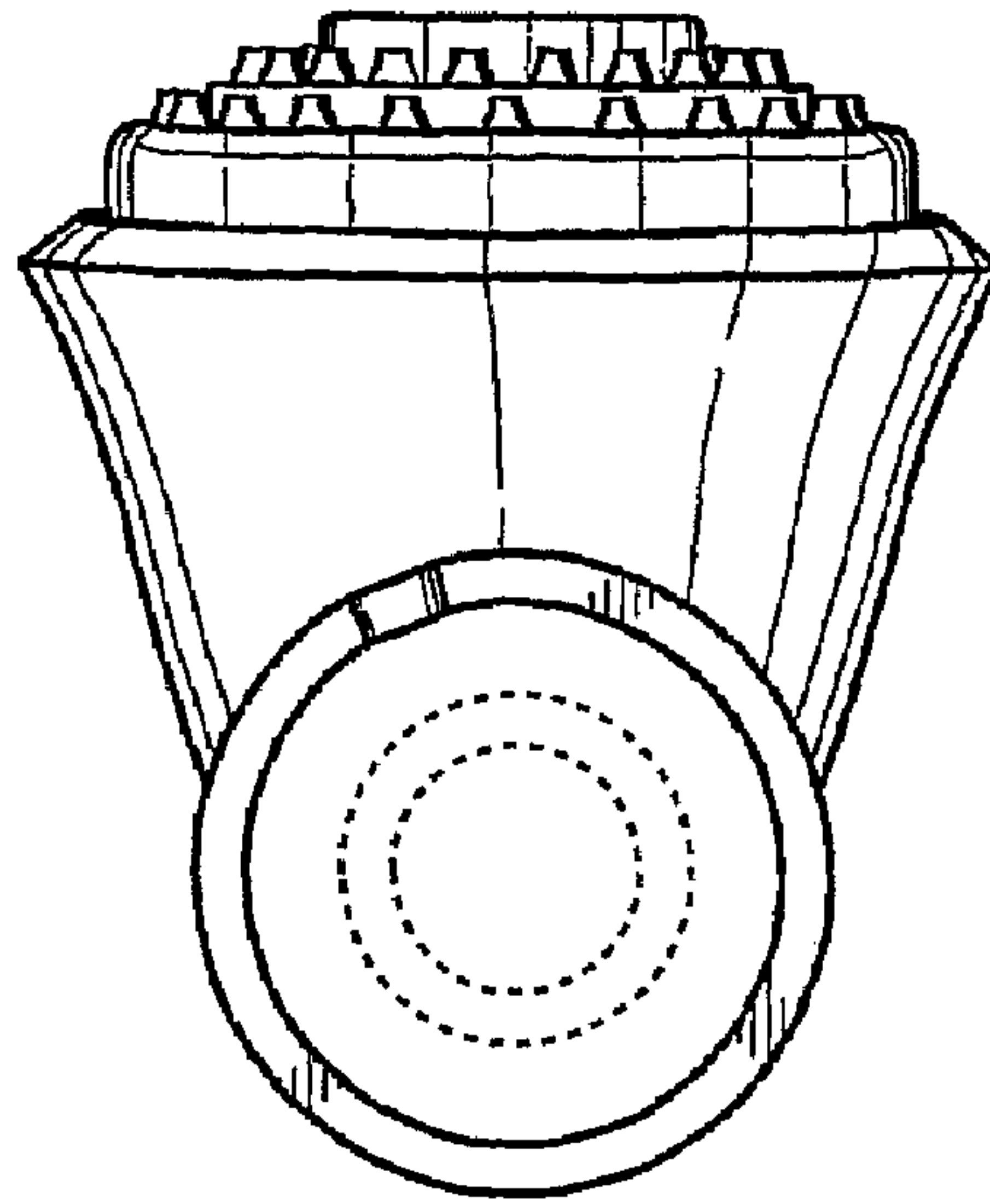

FIG. 6

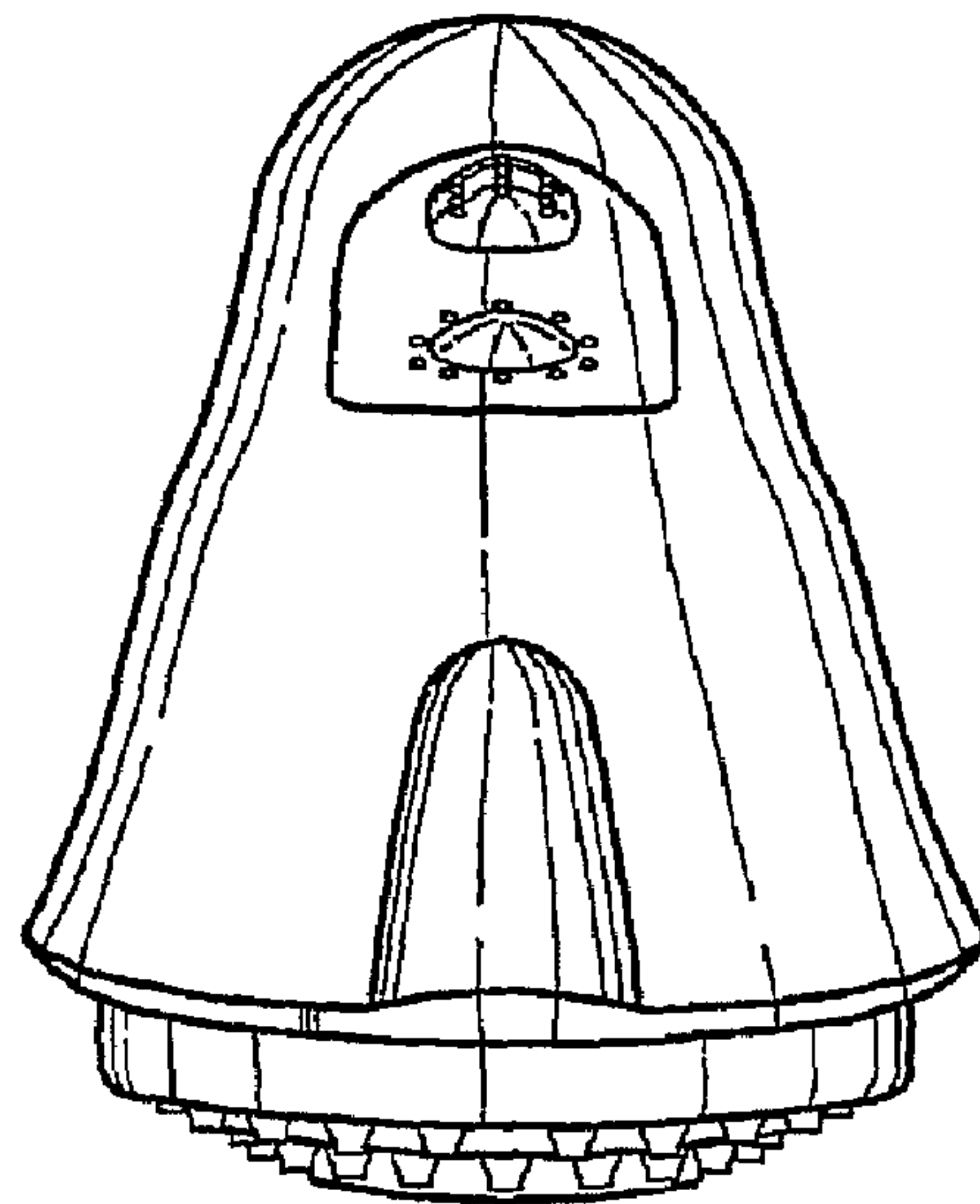

FIG. 7



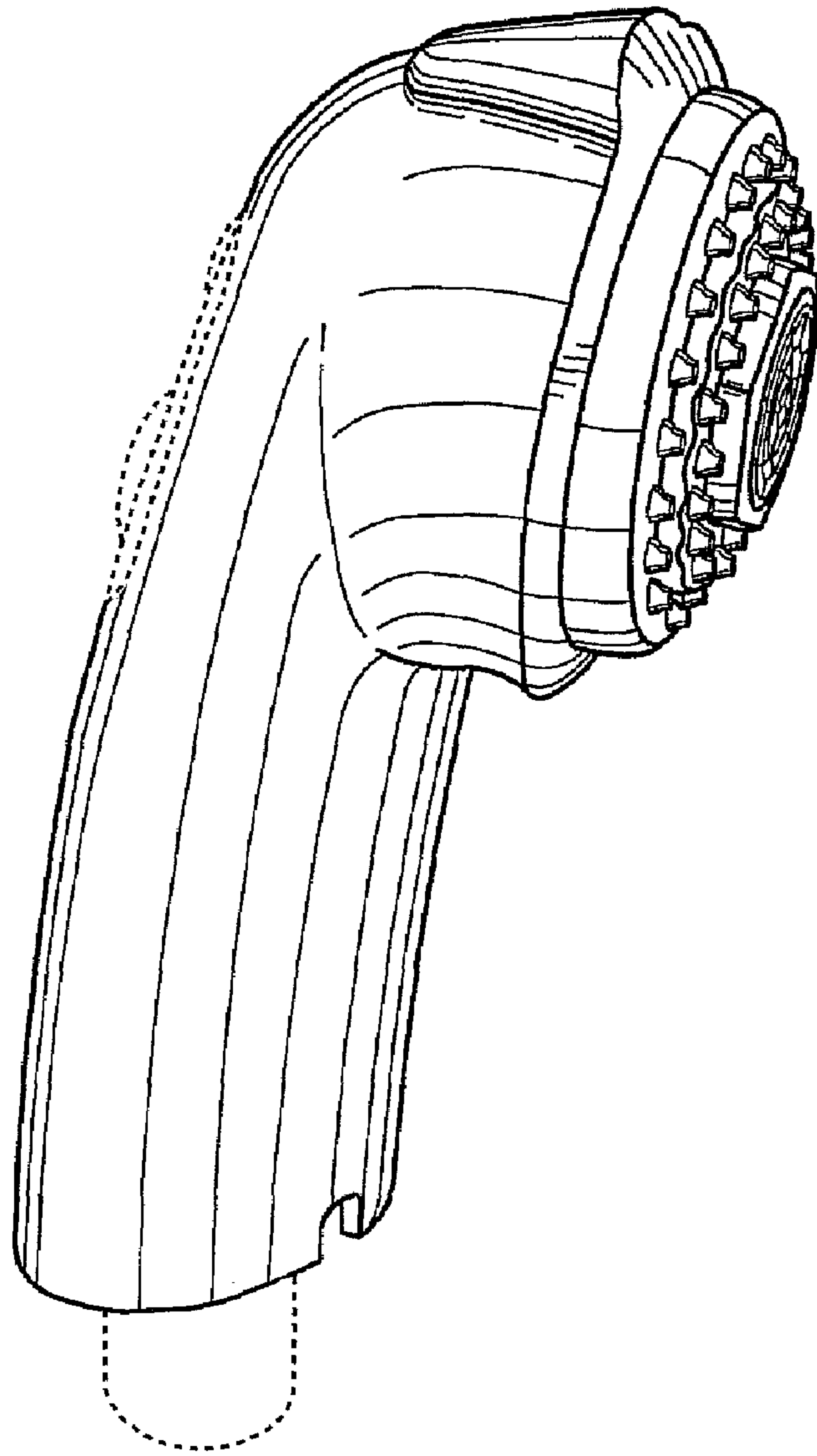

FIG. 8



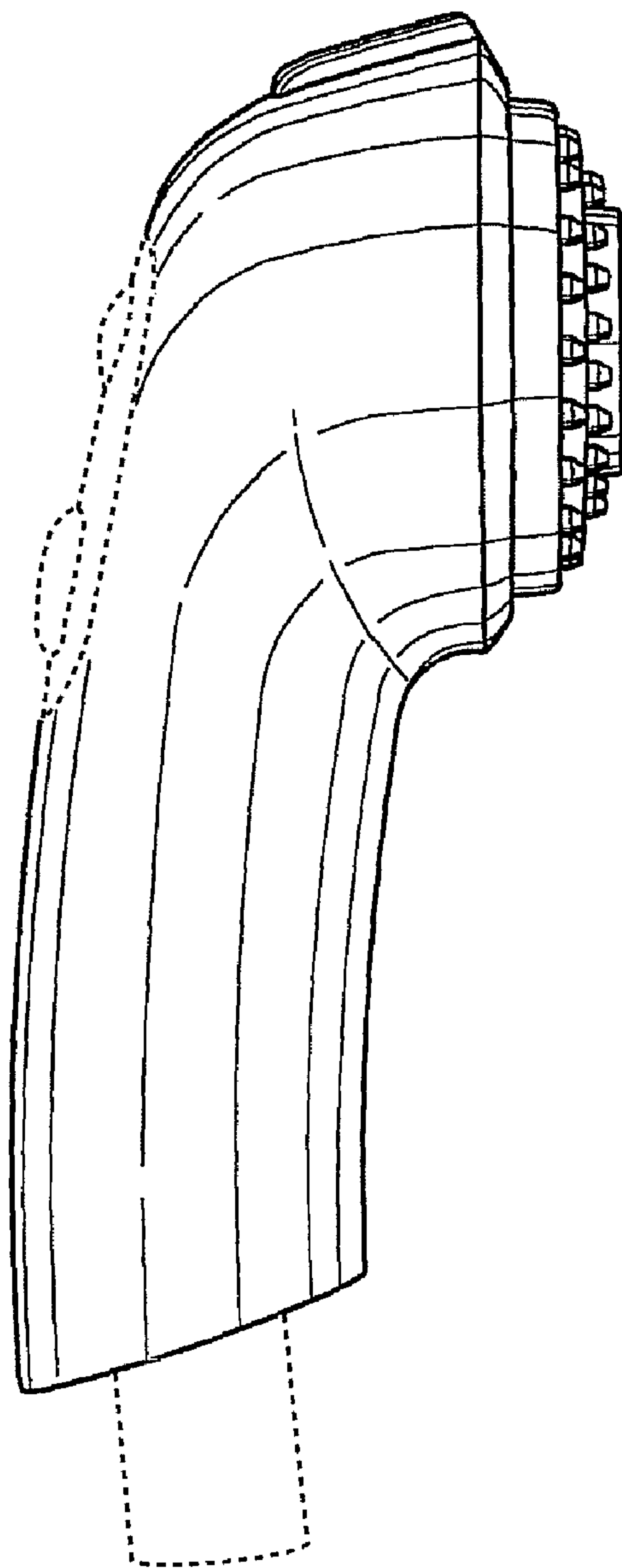

FIG. 9

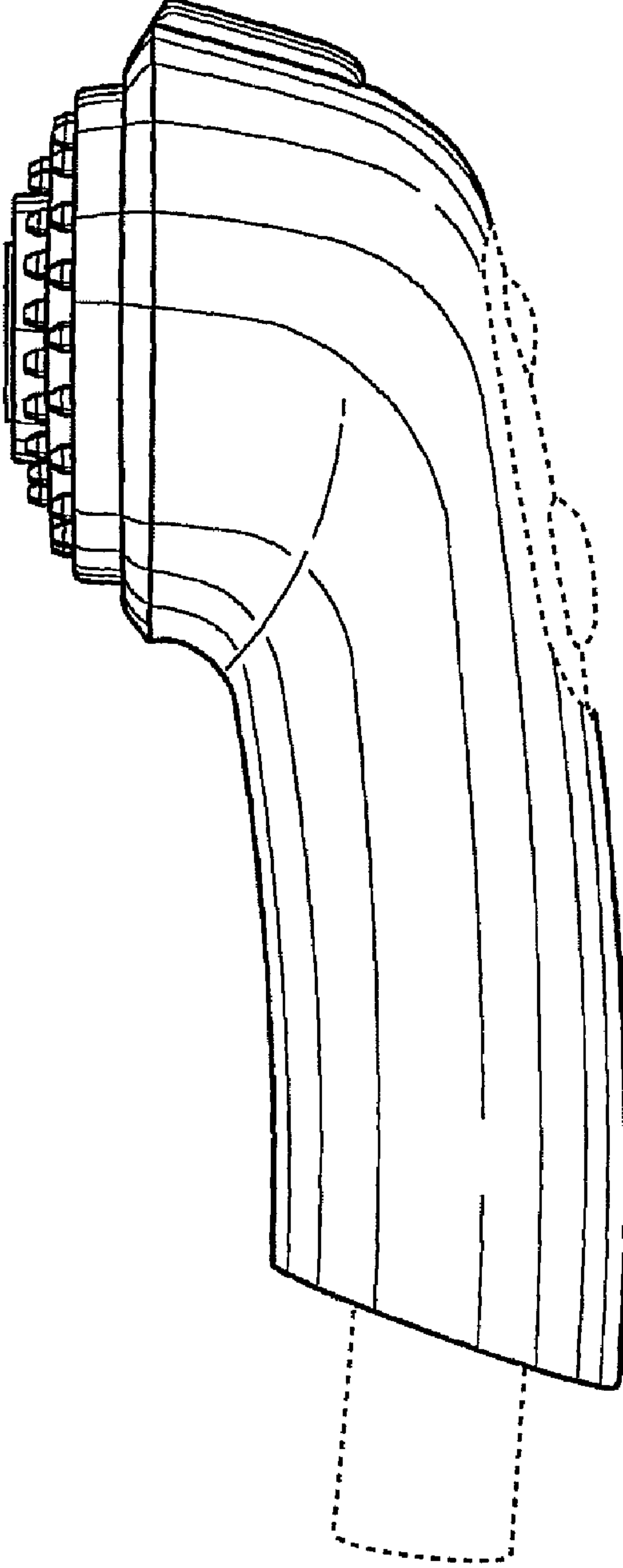
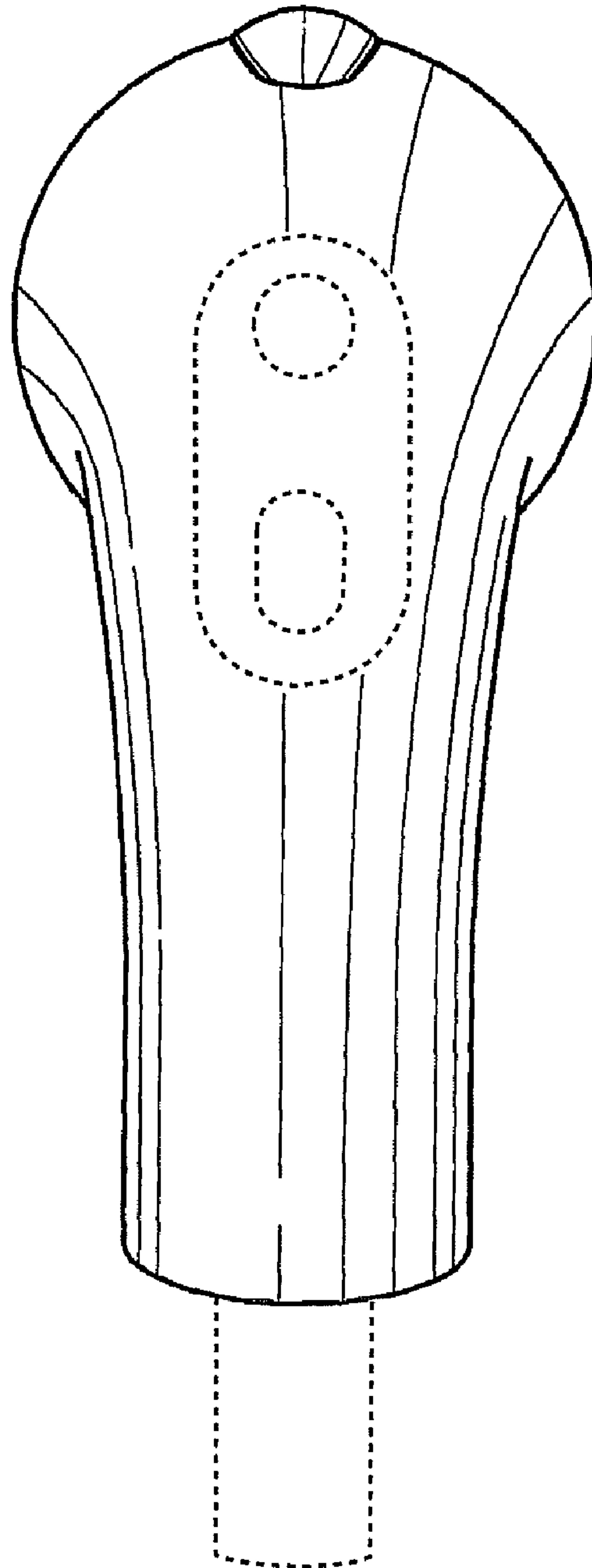

FIG. 10



**FIG. 11**

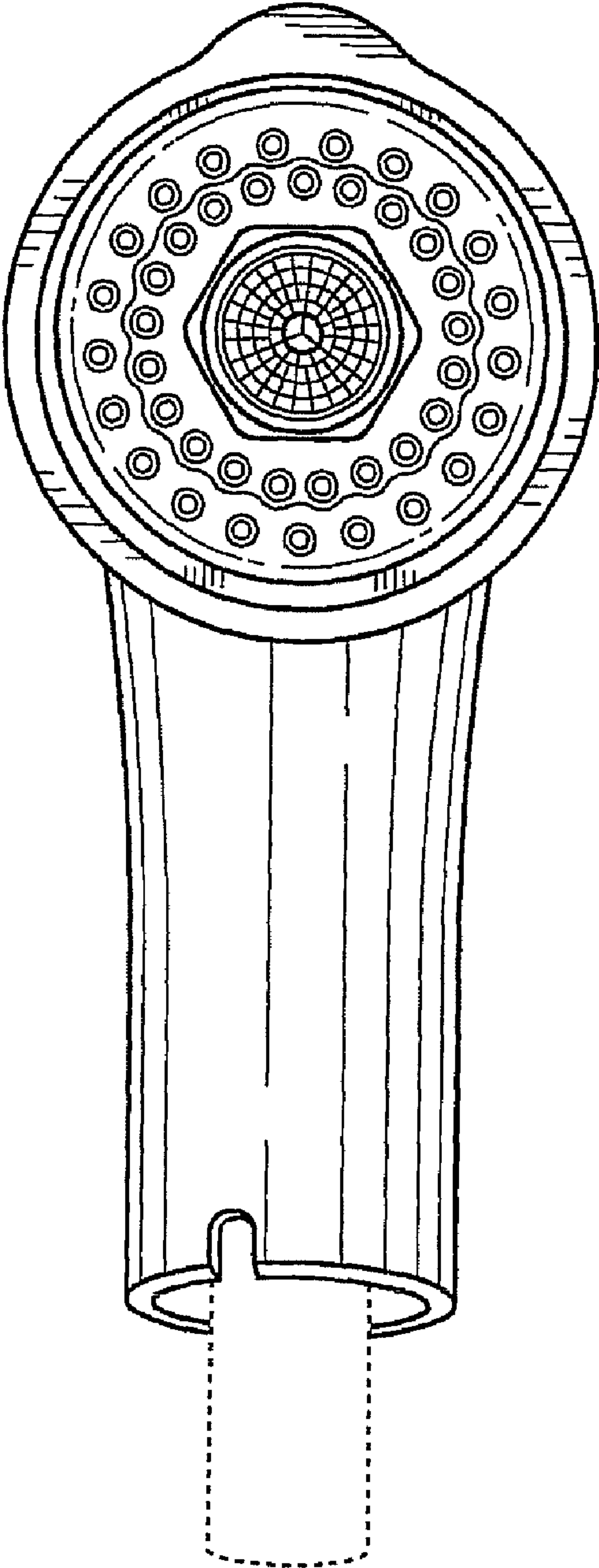
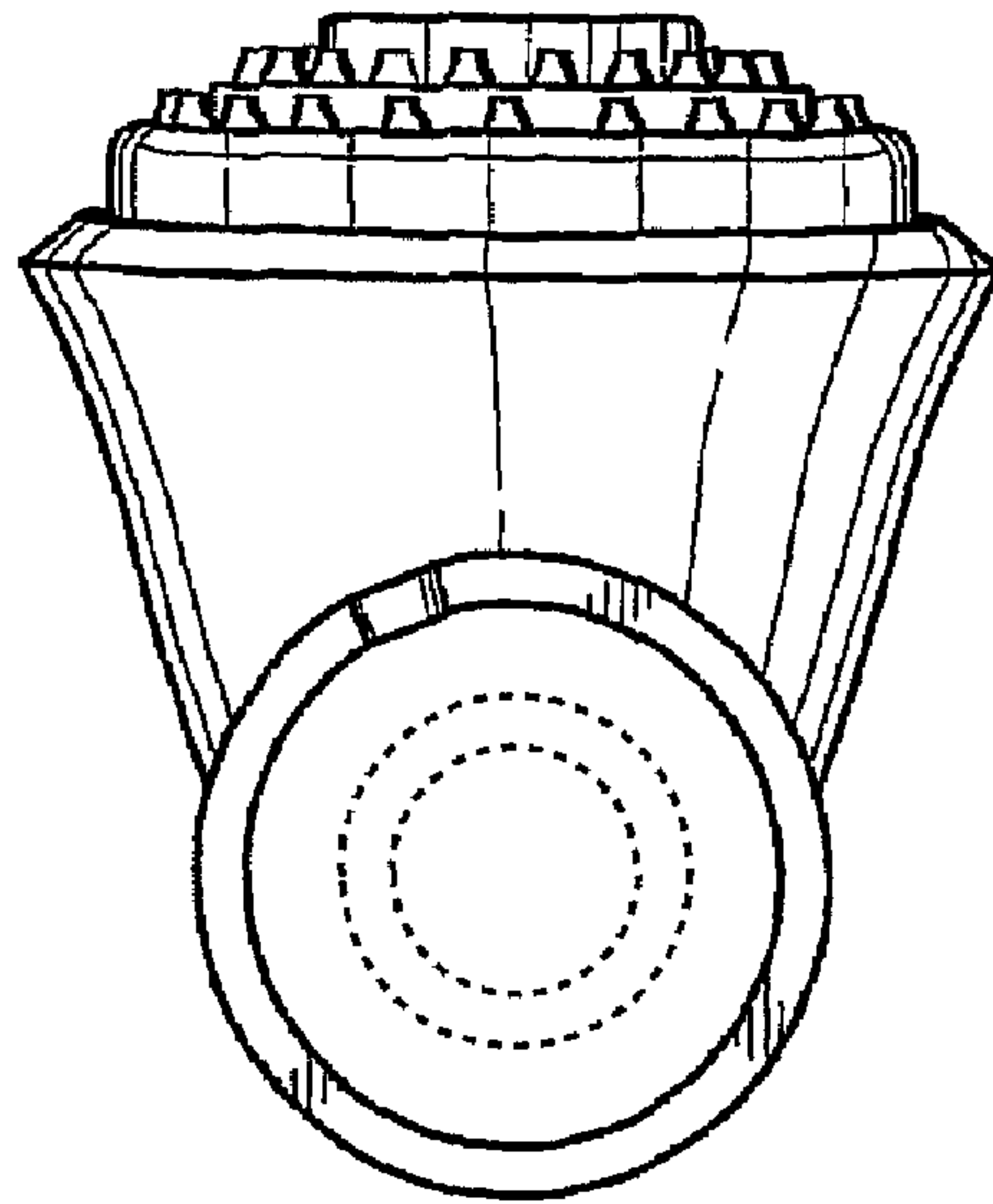
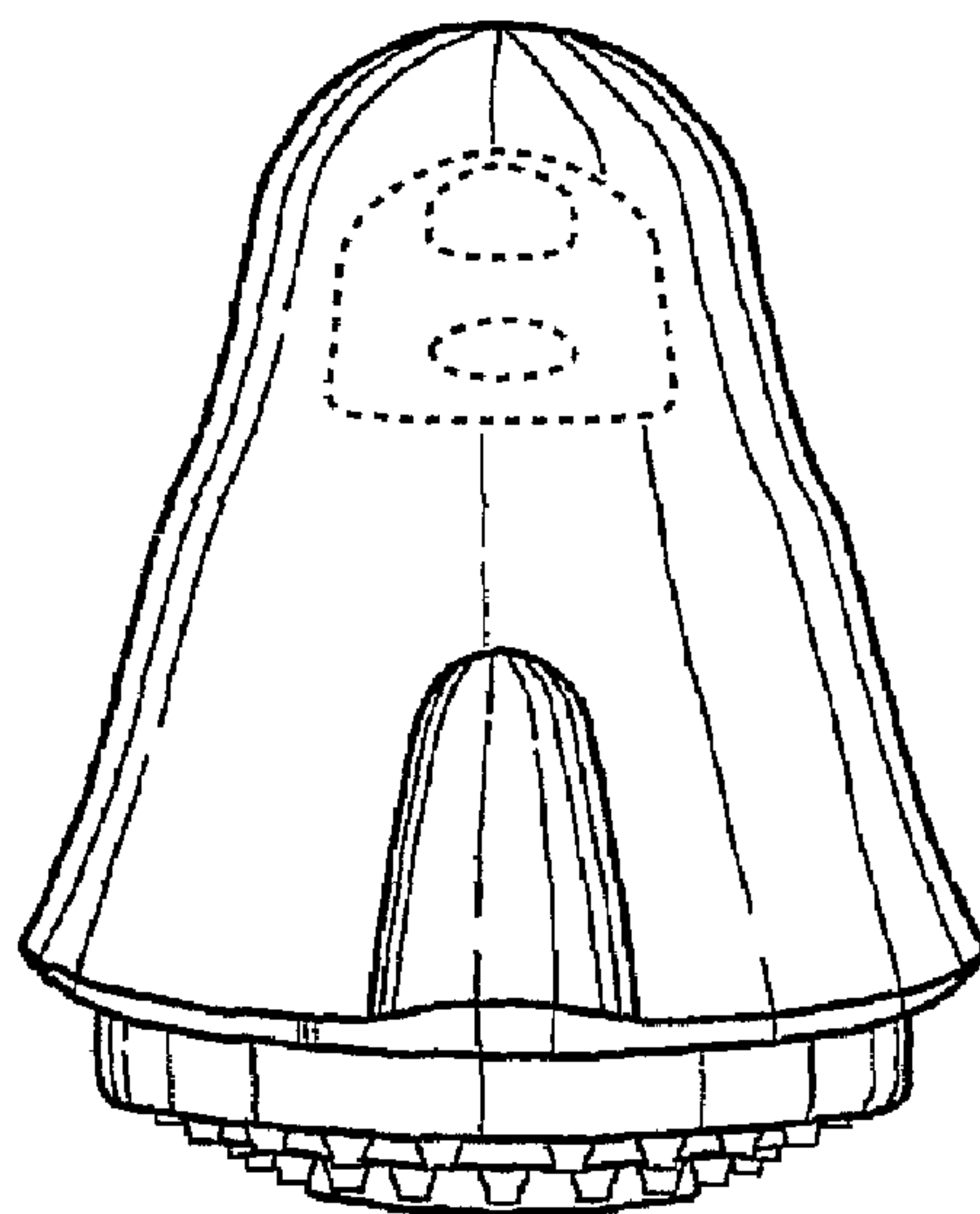

FIG. 12



**FIG. 13**



**FIG. 14**