



US00D614258S

(12) **United States Design Patent**
Kojima

(10) **Patent No.:** **US D614,258 S**
(45) **Date of Patent:** **** Apr. 20, 2010**

- (54) **MOTIONLESS MIXER**
- (75) Inventor: **Hisao Kojima**, Kanagawa (JP)
- (73) Assignee: **Anemos Company Ltd.**, Tokyo (JP)
- (**) Term: **14 Years**
- (21) Appl. No.: **29/267,141**
- (22) Filed: **Oct. 6, 2006**
- (30) **Foreign Application Priority Data**
Apr. 6, 2006 (JP) 2006-011661

- JP 2001-62269 A 3/2001
- JP 2003-181256 A 7/2003
- JP 2005-219036 A 8/2005
- WO WO 00/24502 A1 5/2000

OTHER PUBLICATIONS

S. Hagiwara et al., "Motionless Mixer—Basis & Application", NDC 571.3, Sep. 30, 1981, P1-P7, The Nikkan Kogyo Shimbun Ltd., Tokyo, Japan.

* cited by examiner

Primary Examiner—Robin V Webster
(74) *Attorney, Agent, or Firm*—Ditthavong Mori & Steiner, P.C.

- (51) **LOC (9) Cl.** **23-01**
- (52) **U.S. Cl.** **D23/200**
- (58) **Field of Classification Search** D23/200,
D23/207, 266, 263; 138/37, 39, 42; 366/336–340
See application file for complete search history.

(57) **CLAIM**

The ornamental design for a motionless mixer, as shown.

DESCRIPTION

FIG. 1 is a front side elevational view of a motionless mixer showing my new design;

FIG. 2 is a rear side elevational view thereof;

FIG. 3 is a left side elevational view thereof;

FIG. 4 is a right side elevational view thereof;

FIG. 5 is a top plan view thereof;

FIG. 6 is a bottom plan view thereof;

FIG. 7 is a reference cross-sectional perspective view of the motionless mixer shown in FIGS. 1–6, taken along a line 7–7 of FIG. 1; and,

FIG. 8 is a reference cross-sectional perspective view thereof, taken along a plane including the center axis of the motionless mixer.

- (56) **References Cited**
- U.S. PATENT DOCUMENTS
- 4,183,682 A * 1/1980 Lieffers 366/339
- 4,466,741 A 8/1984 Kojima
- 4,514,095 A * 4/1985 Ehrfeld et al. 366/340
- 4,643,584 A * 2/1987 Allocca 366/337
- 4,747,697 A 5/1988 Kojima
- 4,824,614 A * 4/1989 Jones 261/76
- 4,850,705 A * 7/1989 Horner 366/339
- 5,758,967 A * 6/1998 King 366/337
- 6,109,781 A * 8/2000 Ogasawara et al. 366/336
- D436,647 S * 1/2001 Etschel et al. D23/200
- 6,394,644 B1 * 5/2002 Streiff 366/337
- 7,137,731 B2 * 11/2006 Carlson 366/337
- 7,198,400 B2 * 4/2007 Unterlander et al. 366/336

FOREIGN PATENT DOCUMENTS

JP 10-85721 A 4/1998

1 Claim, 8 Drawing Sheets

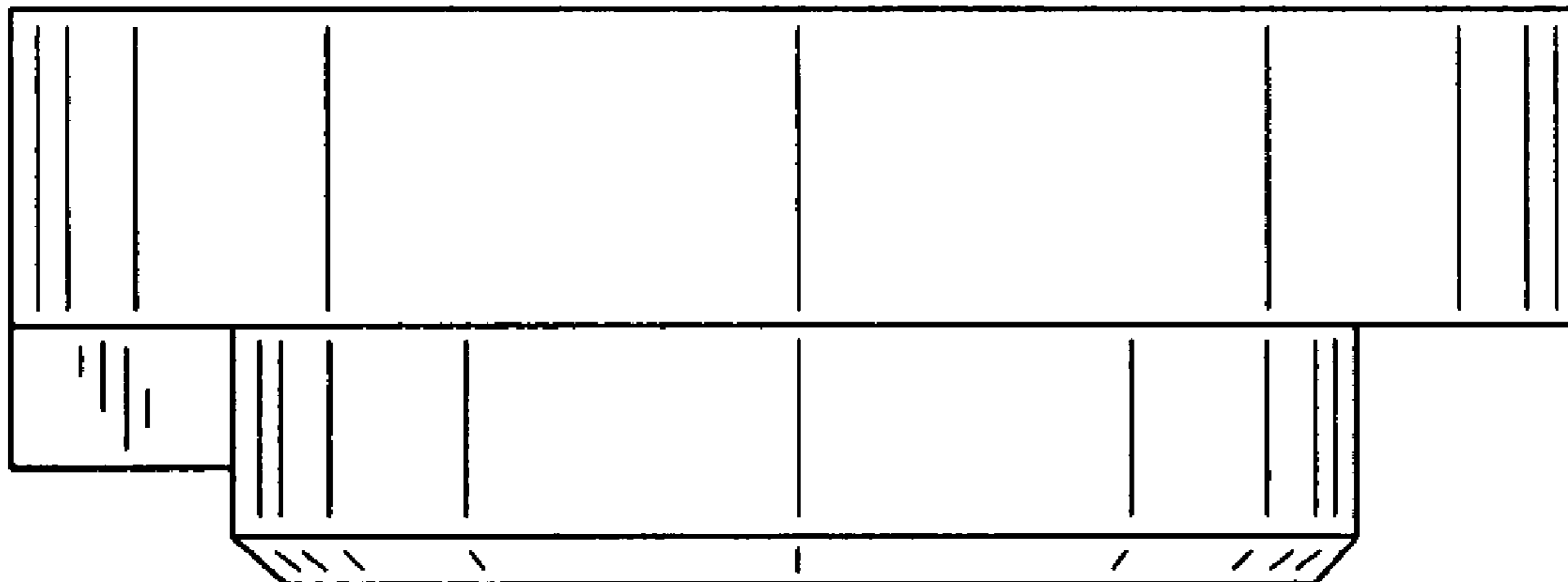

Fig. 1

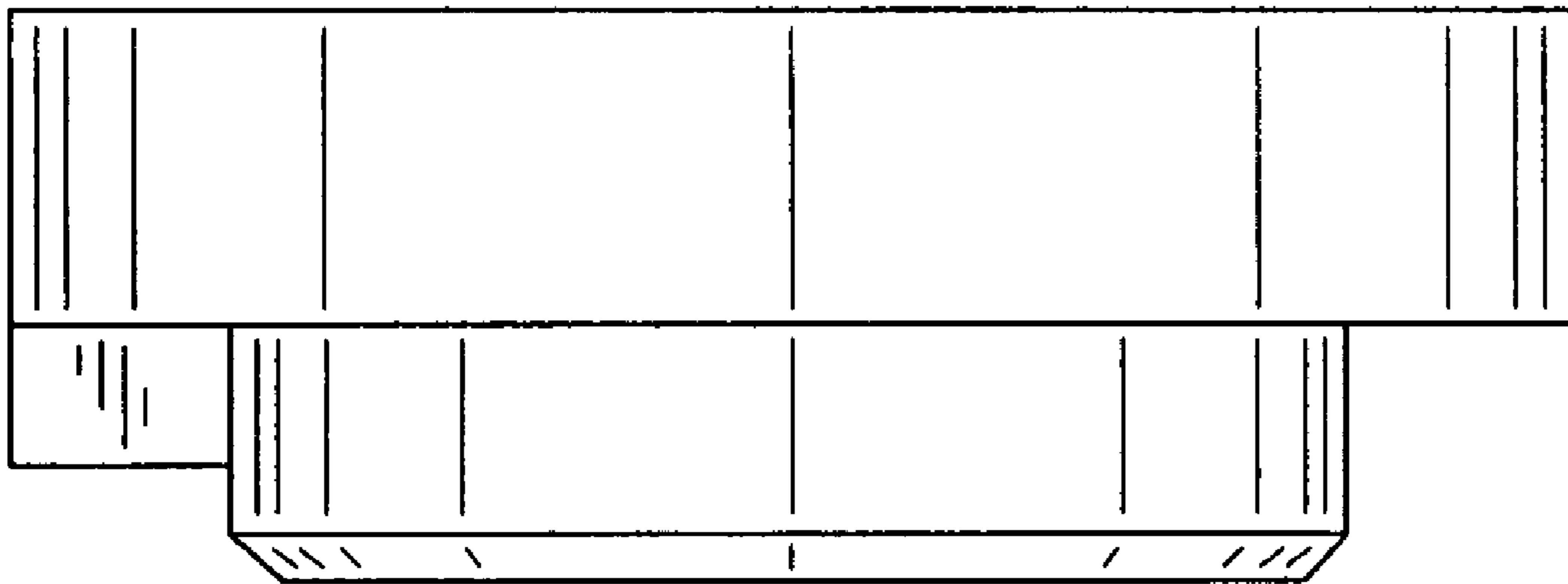

Fig.2

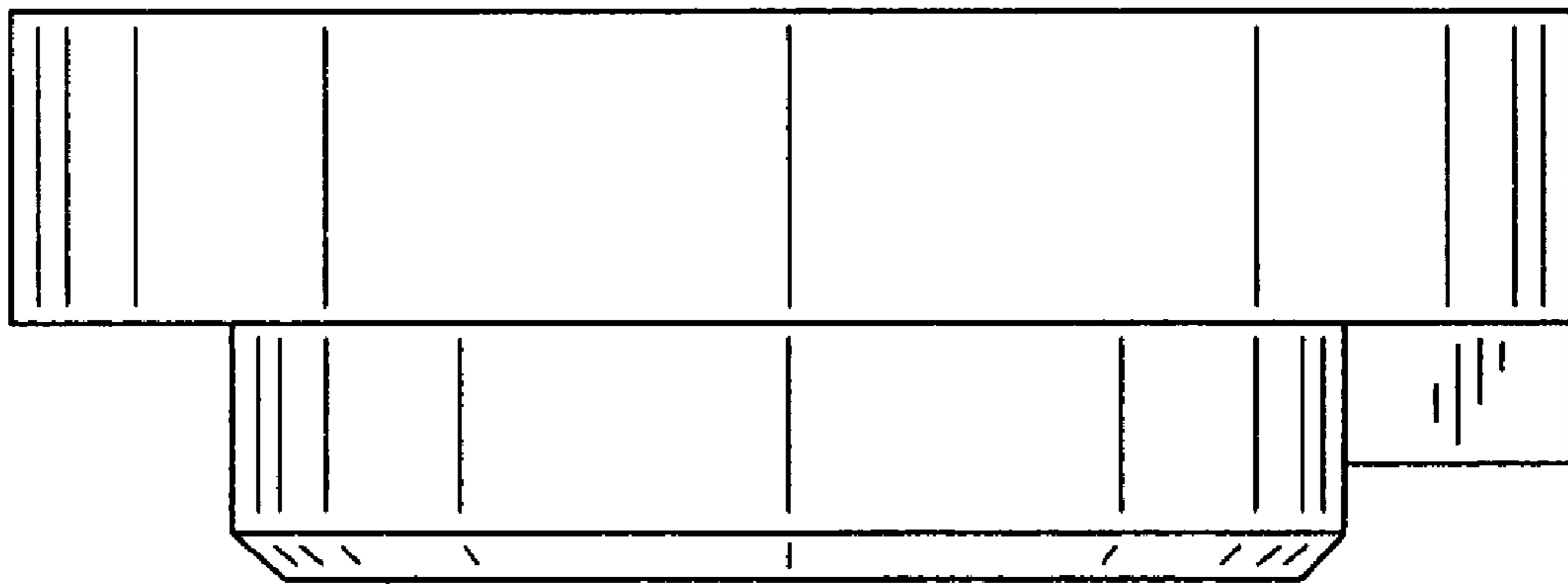

Fig.3

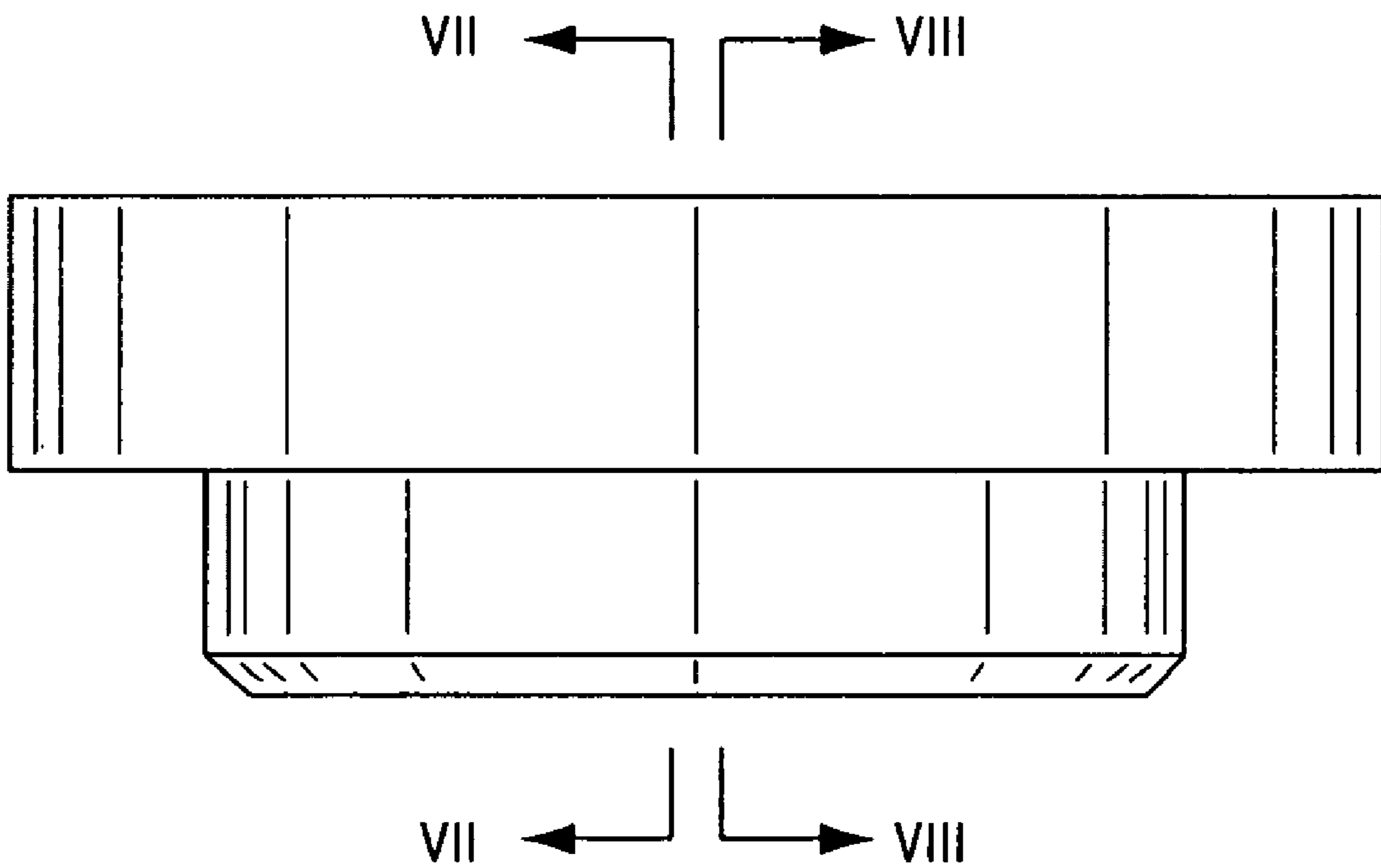

Fig.4

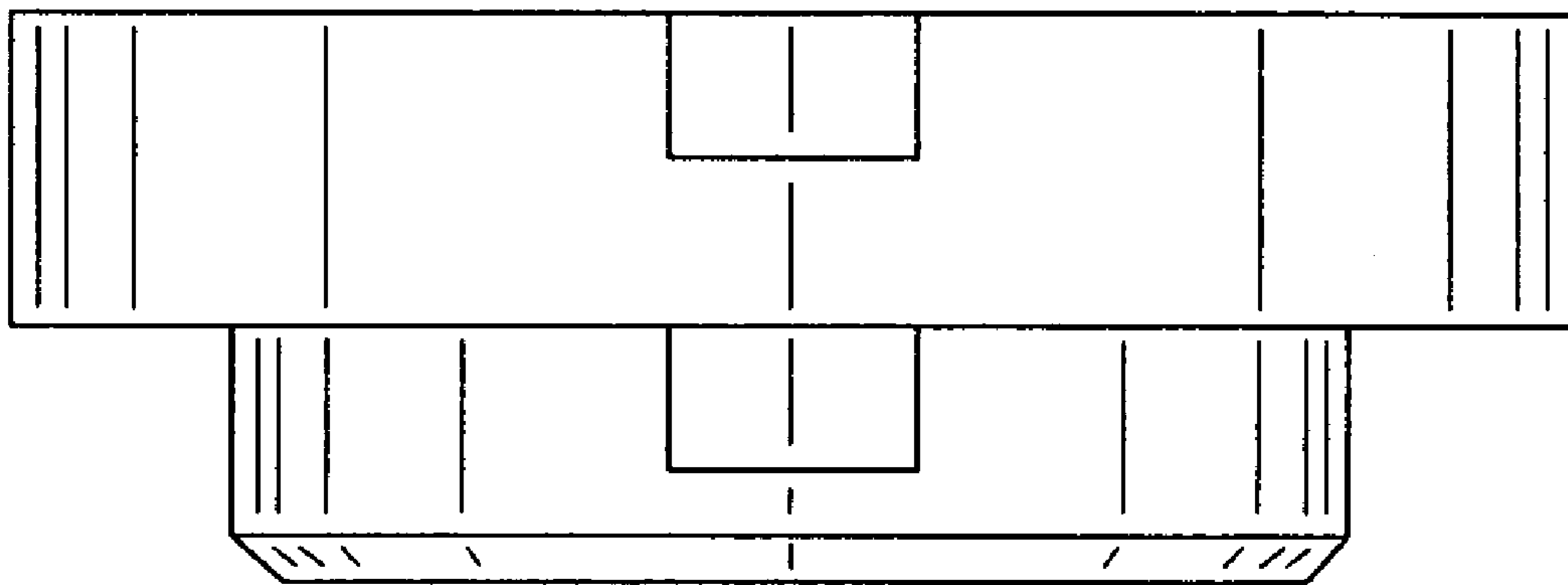

Fig.5

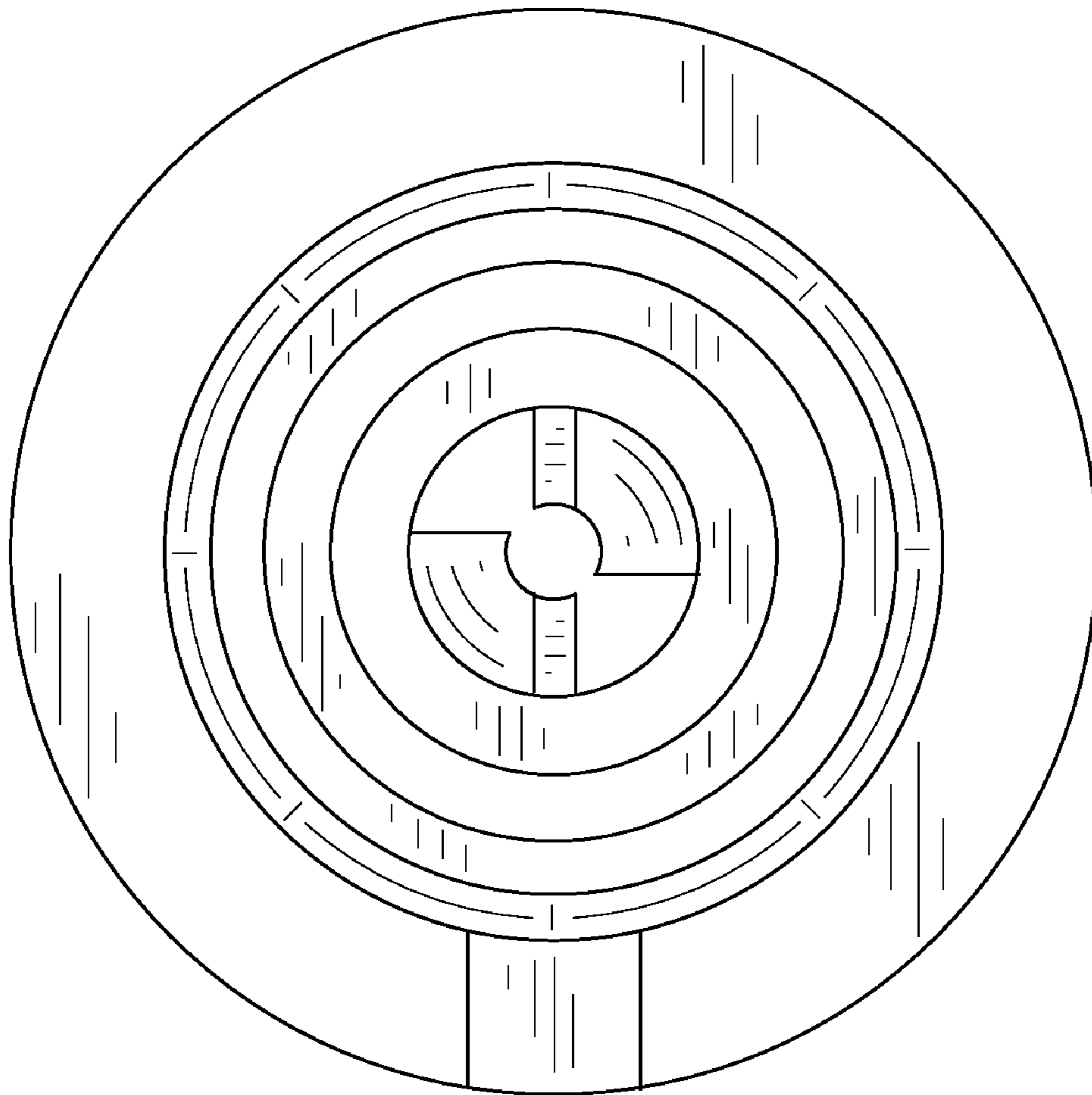

Fig.6

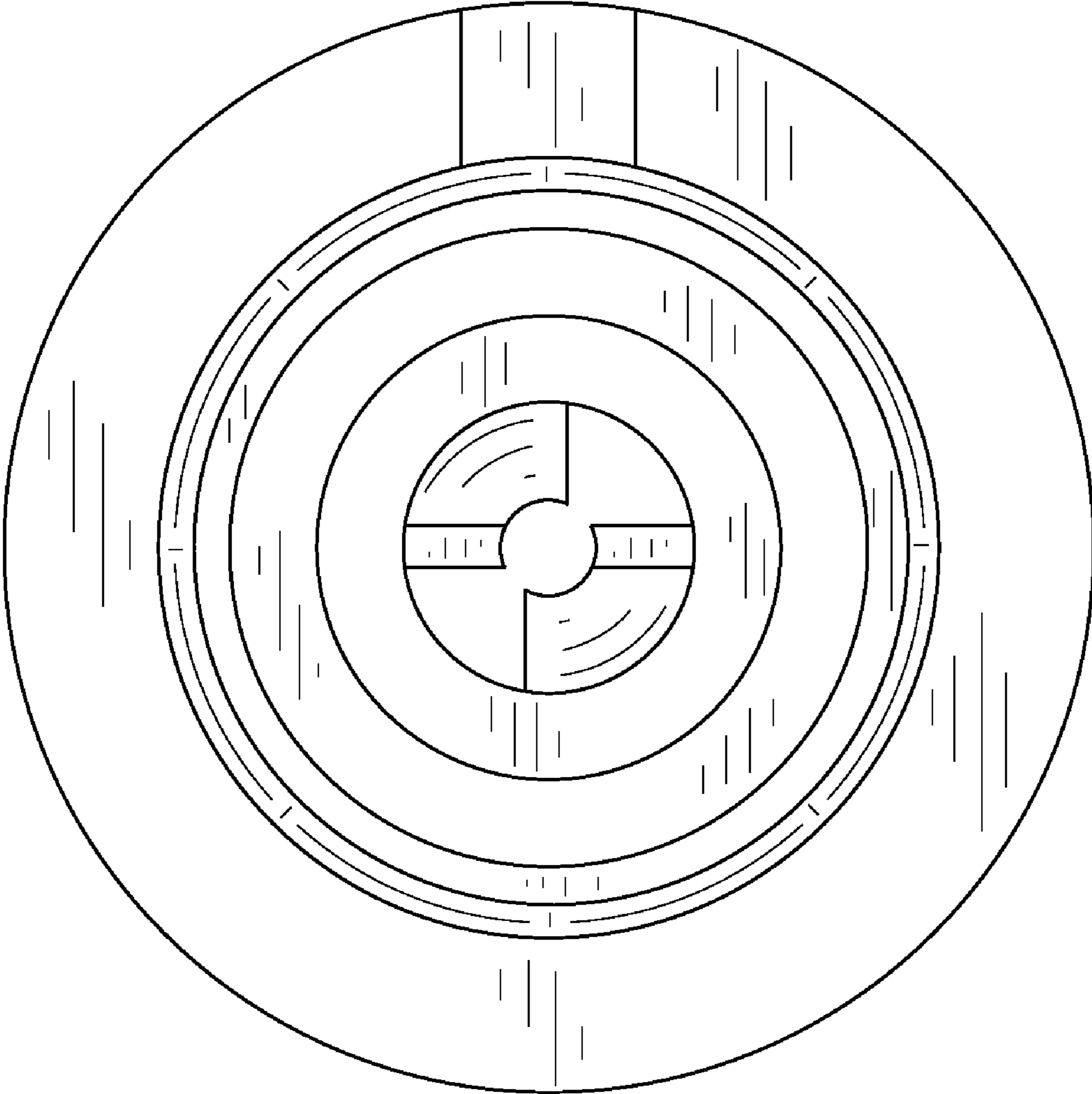

Fig.7

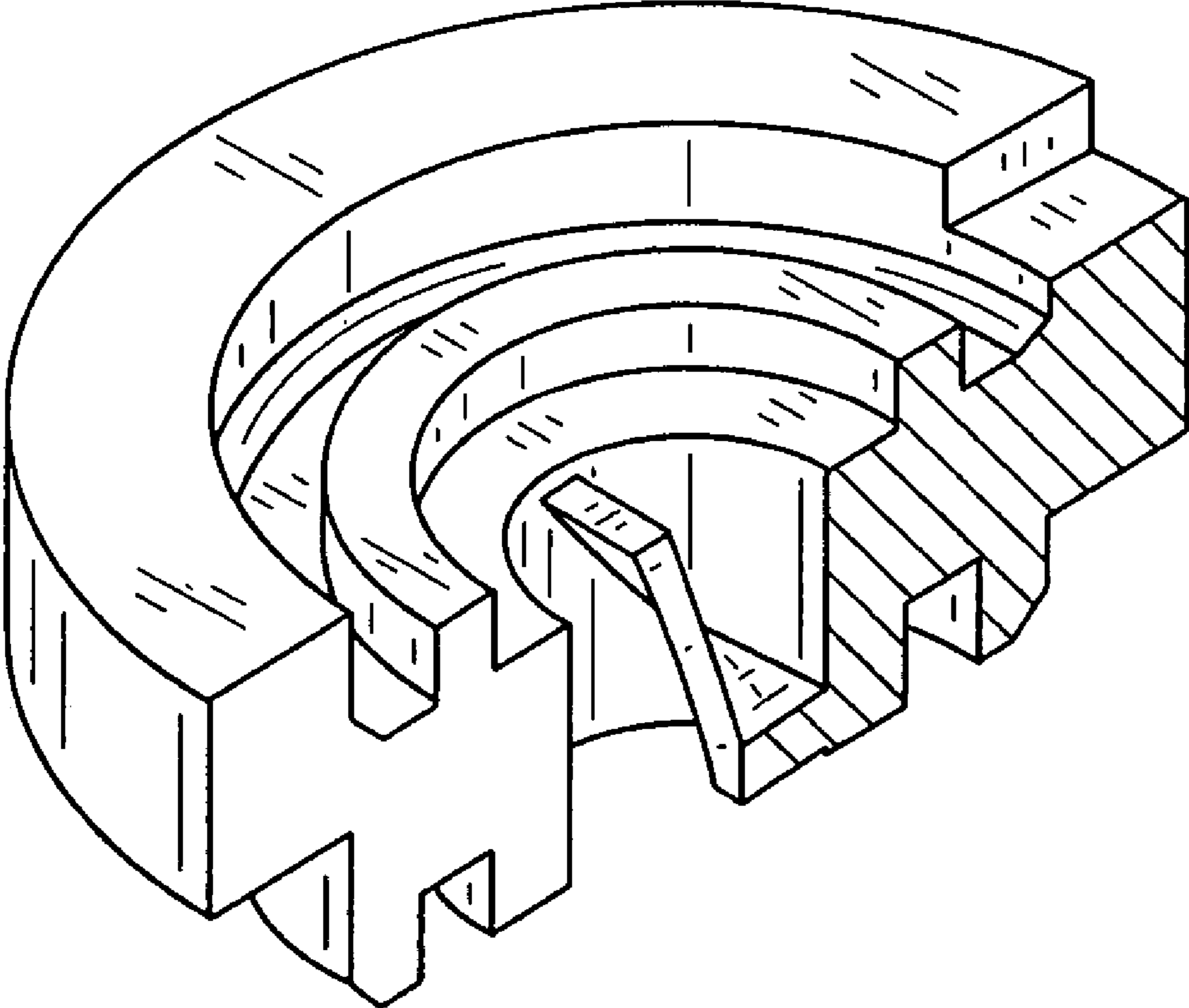

Fig.8

