



US00D614097S

(12) **United States Design Patent**  
**Noguchi et al.**

(10) **Patent No.:** **US D614,097 S**  
(45) **Date of Patent:** **\*\* Apr. 20, 2010**

(54) **HOOD FOR AUTOMOBILE**

D598,341 S \* 8/2009 George et al. .... D12/173  
D600,609 S \* 9/2009 Mattin et al. .... D12/173

(75) Inventors: **Takashi Noguchi**, Kanagawa (JP);  
**Matthew Weaver**, London (GB)

\* cited by examiner

(73) Assignee: **Nissan Jidosha Kabushiki Kaisha**,  
Kanagawa-ku, Yokohama-shi,  
Kanagawa-ken (JP)

*Primary Examiner*—Melody N Brown  
(74) *Attorney, Agent, or Firm*—Fross Zelnick Lehrman &  
Zissu, P.C.; Lawrence E. Apolzon, Esq.

(\*\*) Term: **14 Years**

(57) **CLAIM**

(21) Appl. No.: **29/316,073**

The ornamental design for a hood for automobile, as shown  
and described.

(22) Filed: **Aug. 20, 2009**

**DESCRIPTION**

(30) **Foreign Application Priority Data**

Feb. 24, 2009 (JP) ..... 2009-003758

FIG. 1 is a perspective view of the front, right and top of a  
hood for automobile showing our new design;

(51) **LOC (9) Cl.** ..... **12-16**

FIG. 2 is a front view thereof;

(52) **U.S. Cl.** ..... **D12/173**

FIG. 3 is a rear view thereof;

(58) **Field of Classification Search** ..... D12/173,  
D12/196, 86, 90-92; 180/69.21, 69.2, 69.22  
See application file for complete search history.

FIG. 4 is a top plan view thereof;

FIG. 5 is a bottom view thereof;

FIG. 6 is a left side view thereof; and,

FIG. 7 is a right side view thereof.

(56) **References Cited**

The elements shown in broken lines are of illustrative pur-  
poses only and form no part of the claimed design.

**U.S. PATENT DOCUMENTS**

D597,001 S \* 7/2009 Lamm et al. .... D12/173  
D597,899 S \* 8/2009 Di Buduo ..... D12/173

**1 Claim, 5 Drawing Sheets**

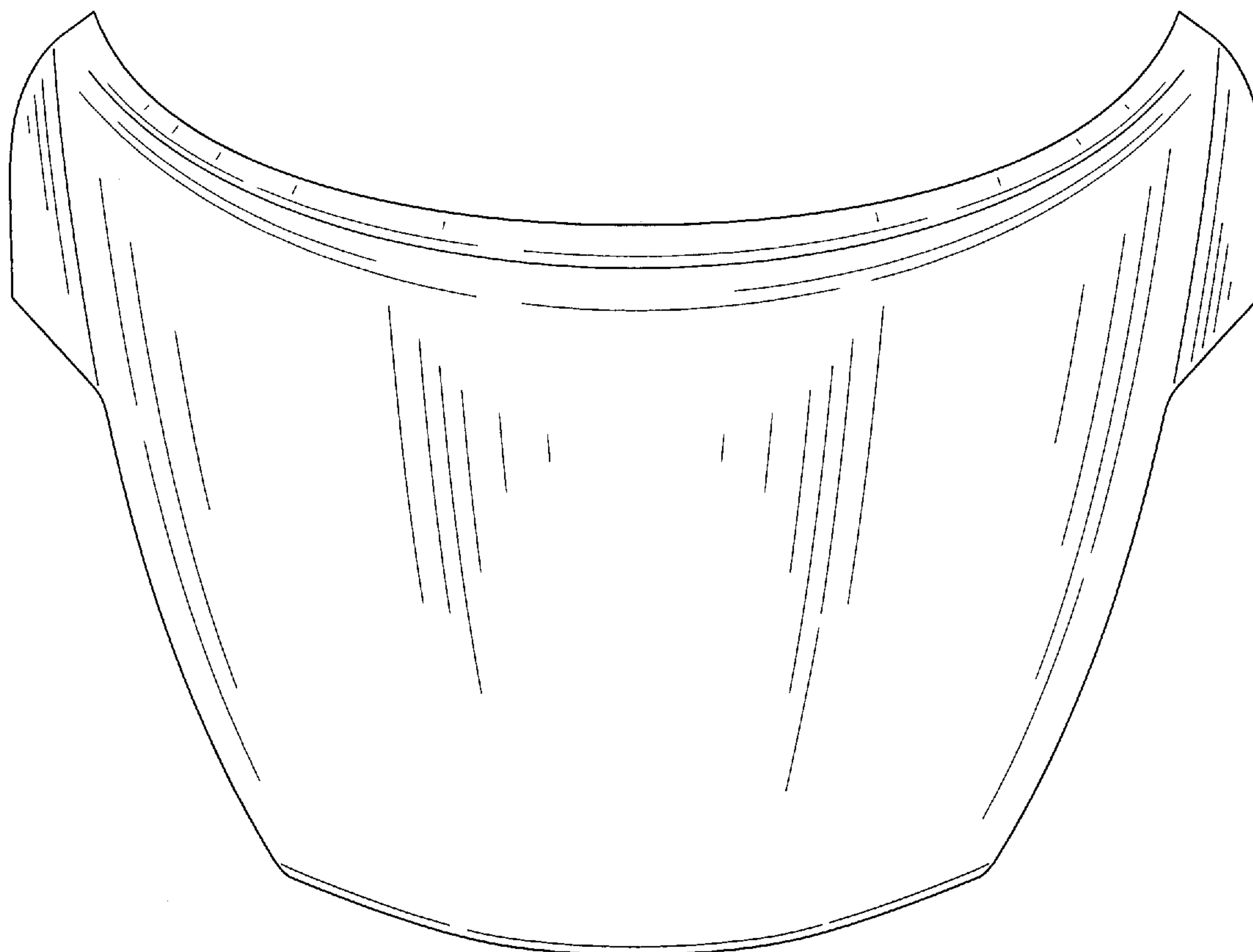

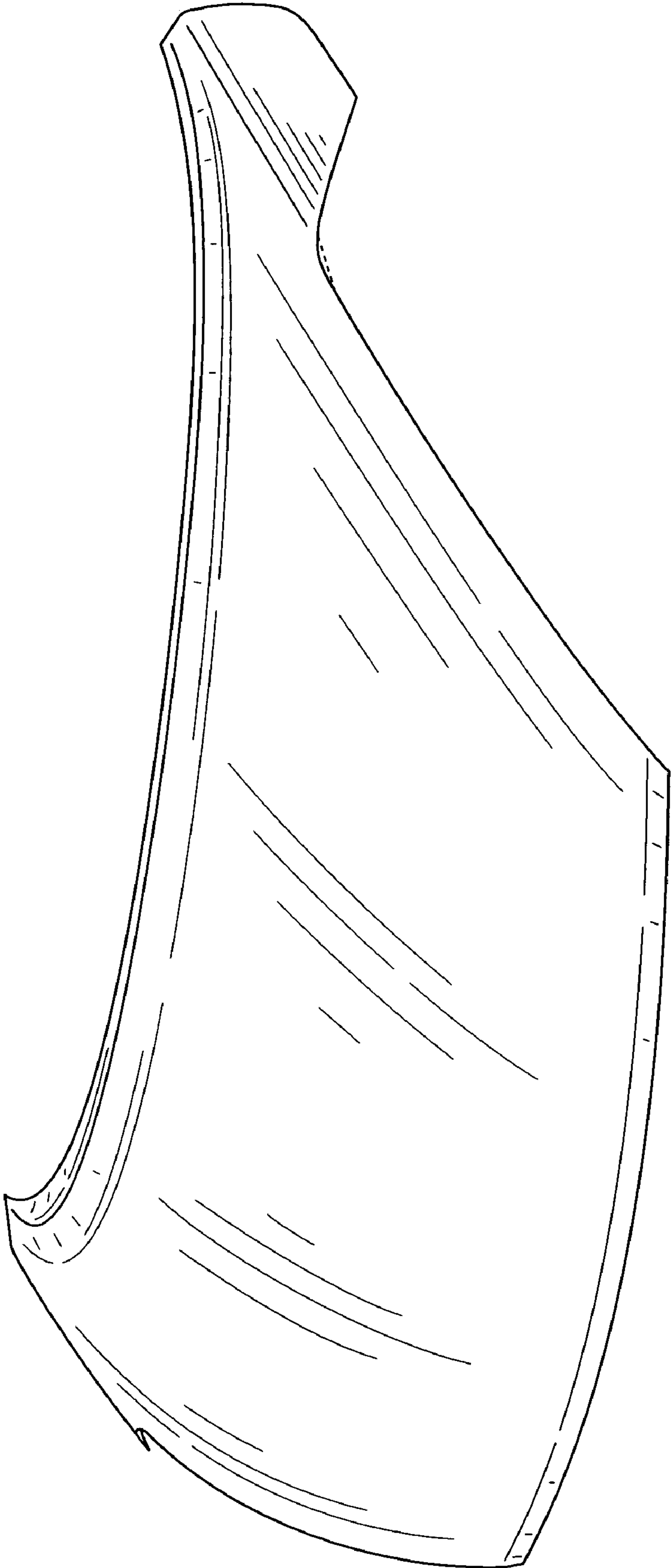

FIG. 1

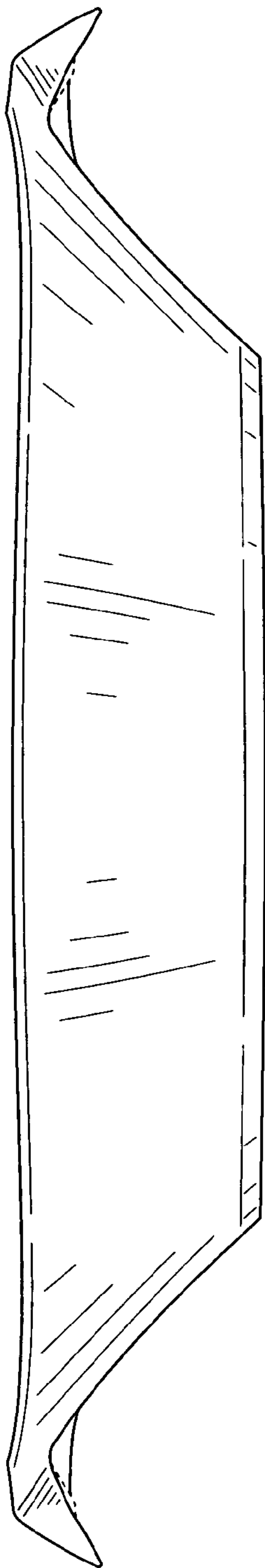

FIG. 2

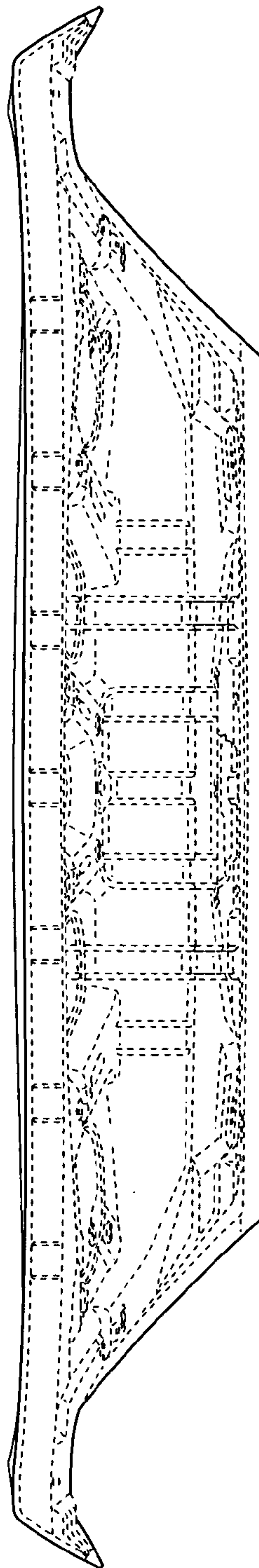

FIG. 3

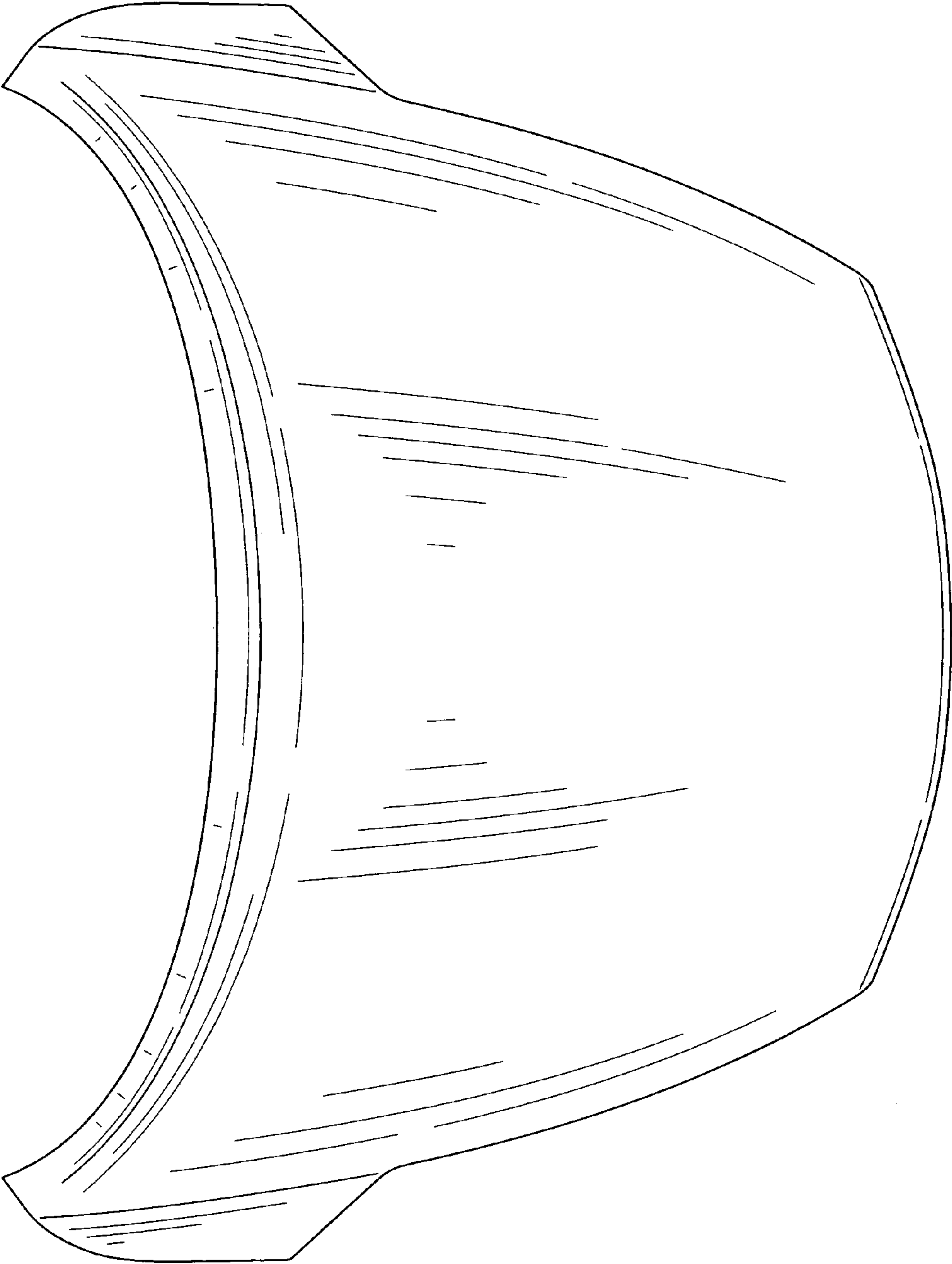

FIG. 4



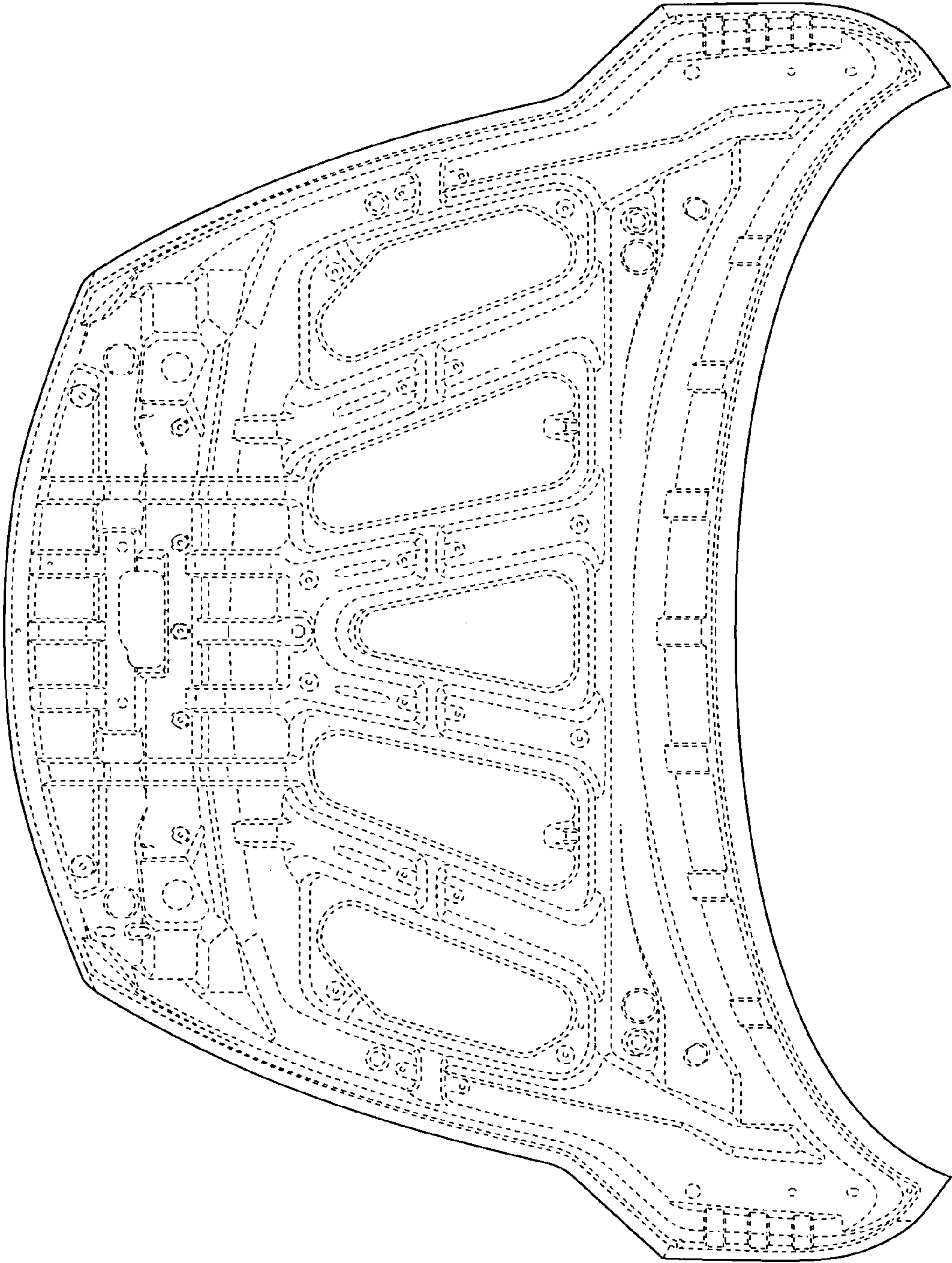

FIG. 5

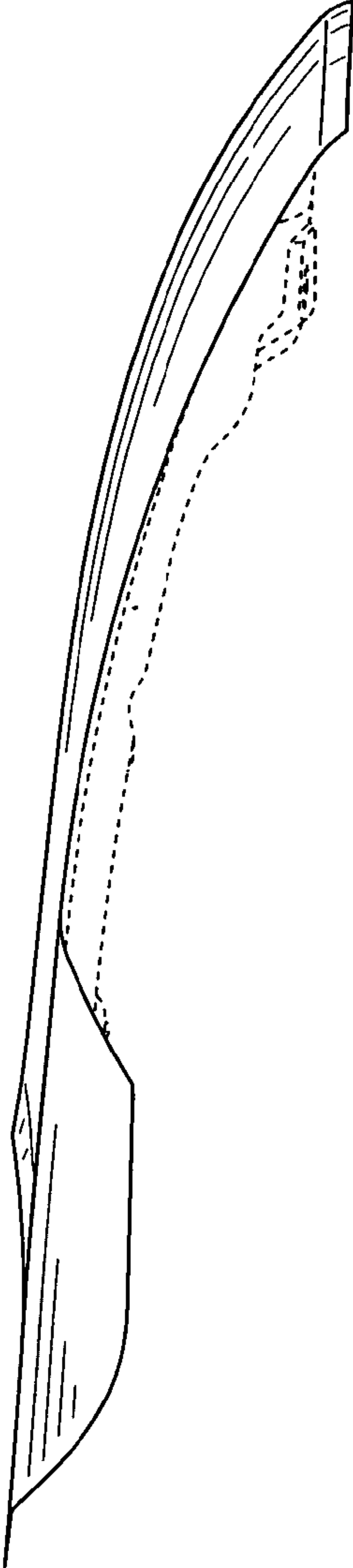

FIG. 6

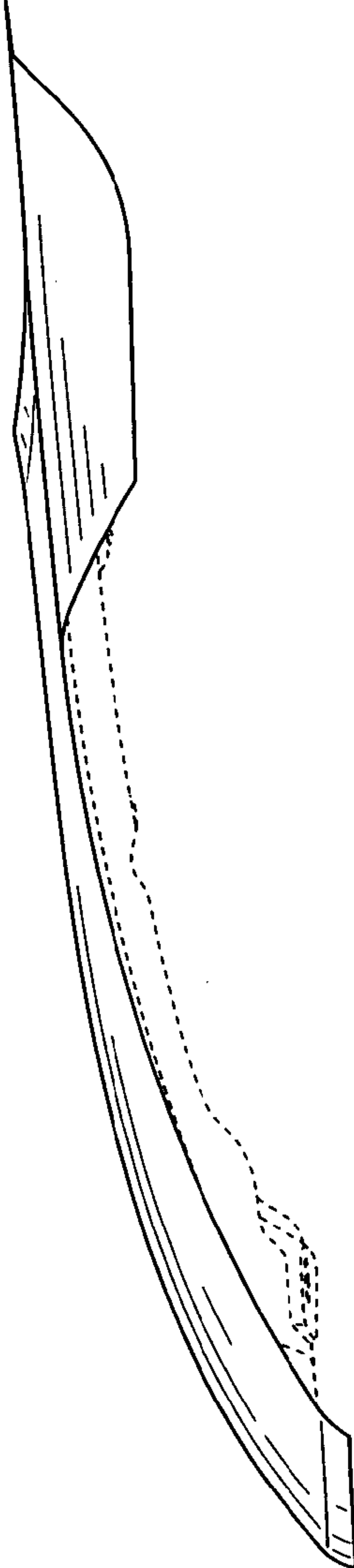

FIG. 7