



US00D614088S

(12) **United States Design Patent**  
**Ono et al.**

(10) **Patent No.:** **US D614,088 S**

(45) **Date of Patent:** **\*\* Apr. 20, 2010**

(54) **FRONT BUMPER FOR AUTOMOBILE**

D565,481 S \* 4/2008 Ohishi et al. .... D12/169  
D570,260 S \* 6/2008 Suzuki et al. .... D12/169  
D600,175 S \* 9/2009 Yamazaki et al. .... D12/169

(75) Inventors: **Hirohisa Ono**, Kanagawa (JP);  
**Matthew Weaver**, London (GB)

\* cited by examiner

(73) Assignee: **Nissan Jidosha Kabushiki Kaisha**,  
Kanagawa-ku, Yokohama-shi,  
Kanagawa-ken (JP)

*Primary Examiner*—Melody N Brown  
(74) *Attorney, Agent, or Firm*—Fross Zelnick Lehrman &  
Zissu, P.C.; Lawrence E. Apolzon. Esq.

(\*\*) Term: **14 Years**

(57) **CLAIM**

(21) Appl. No.: **29/316,237**

The ornamental design for a front bumper for automobile, as shown and described.

(22) Filed: **Sep. 3, 2009**

(30) **Foreign Application Priority Data**

**DESCRIPTION**

Mar. 6, 2009 (JP) ..... 2009-004997

FIG. 1 is a perspective view of the front, right and top of a front bumper for automobile showing our new design;

(51) **LOC (9) Cl.** ..... **12-16**

FIG. 2 is a front view thereof;

(52) **U.S. Cl.** ..... **D12/169**

FIG. 3 is a rear view thereof;

(58) **Field of Classification Search** ..... D12/169,  
D12/196, 90-92, 86, 181, 191, 400; 293/102,  
293/113, 115, 117, 120; 296/180.1-180.5,  
296/91; 280/727, 770, 848; 180/903  
See application file for complete search history.

FIG. 4 is a left side view thereof;

FIG. 5 is a right side view thereof;

FIG. 6 is a top plan view thereof; and,

FIG. 7 is a bottom view thereof.

(56) **References Cited**

The elements shown in broken lines are of illustrative purposes only and form no part of the claimed design.

**U.S. PATENT DOCUMENTS**

D559,743 S \* 1/2008 Nakamuta et al. .... D12/169

**1 Claim, 6 Drawing Sheets**

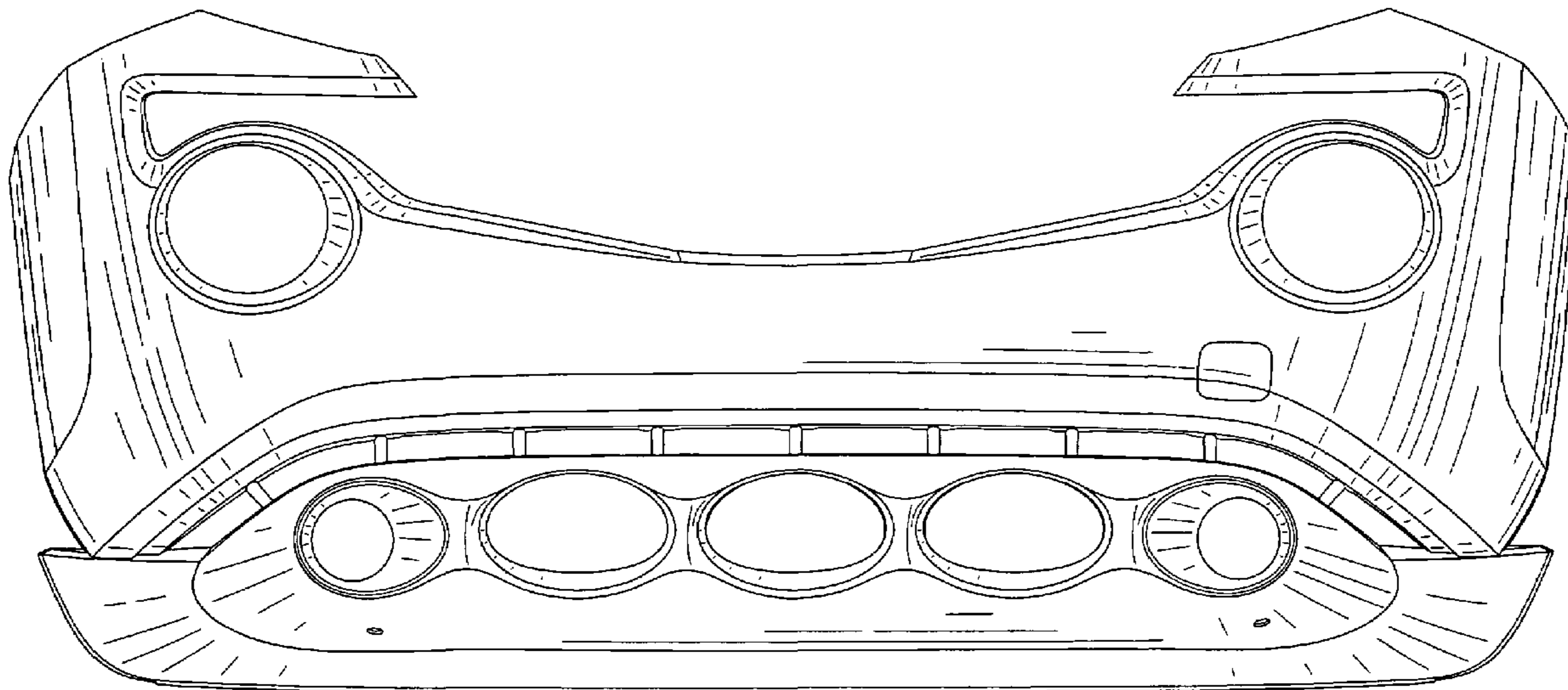

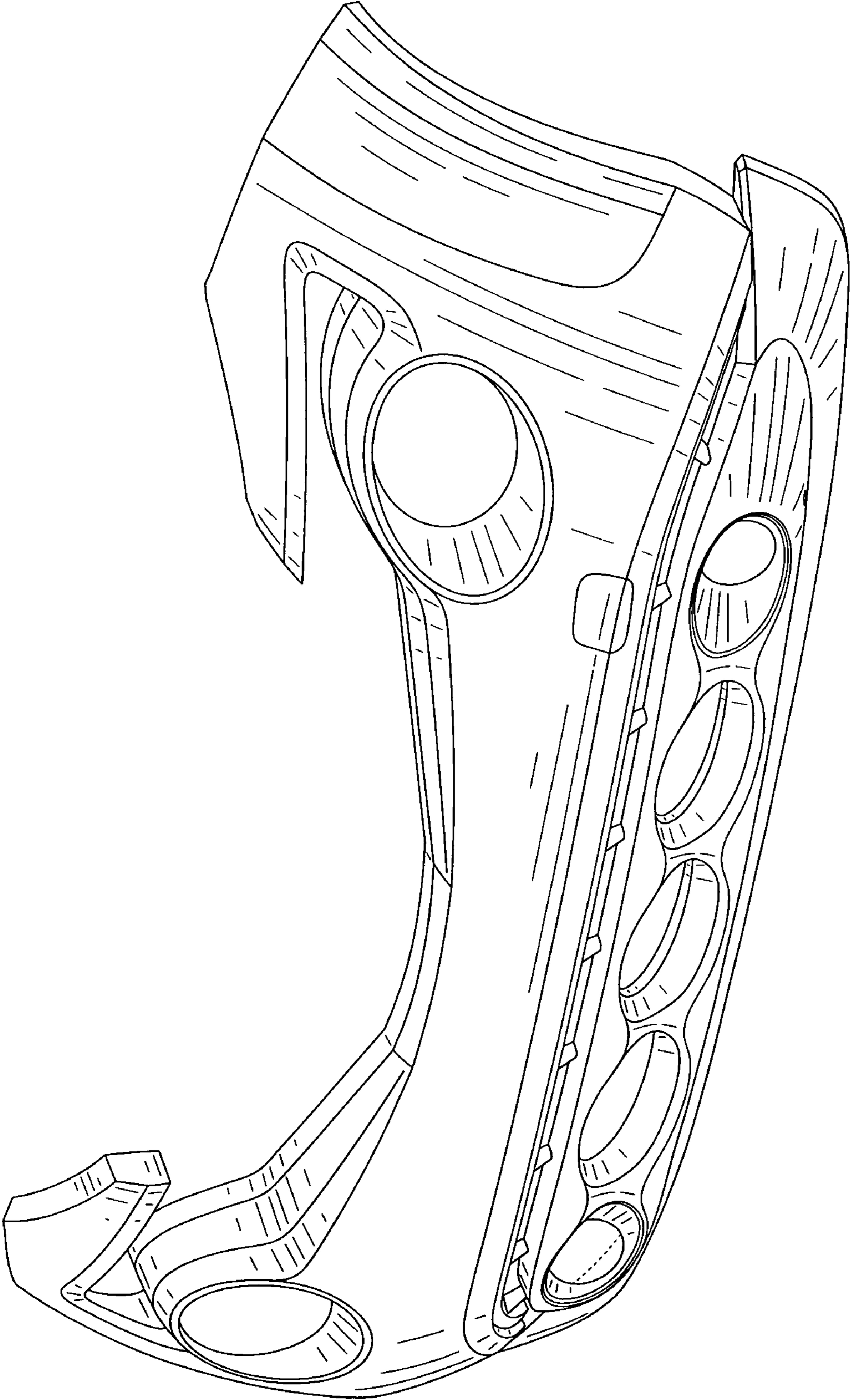

FIG. 1

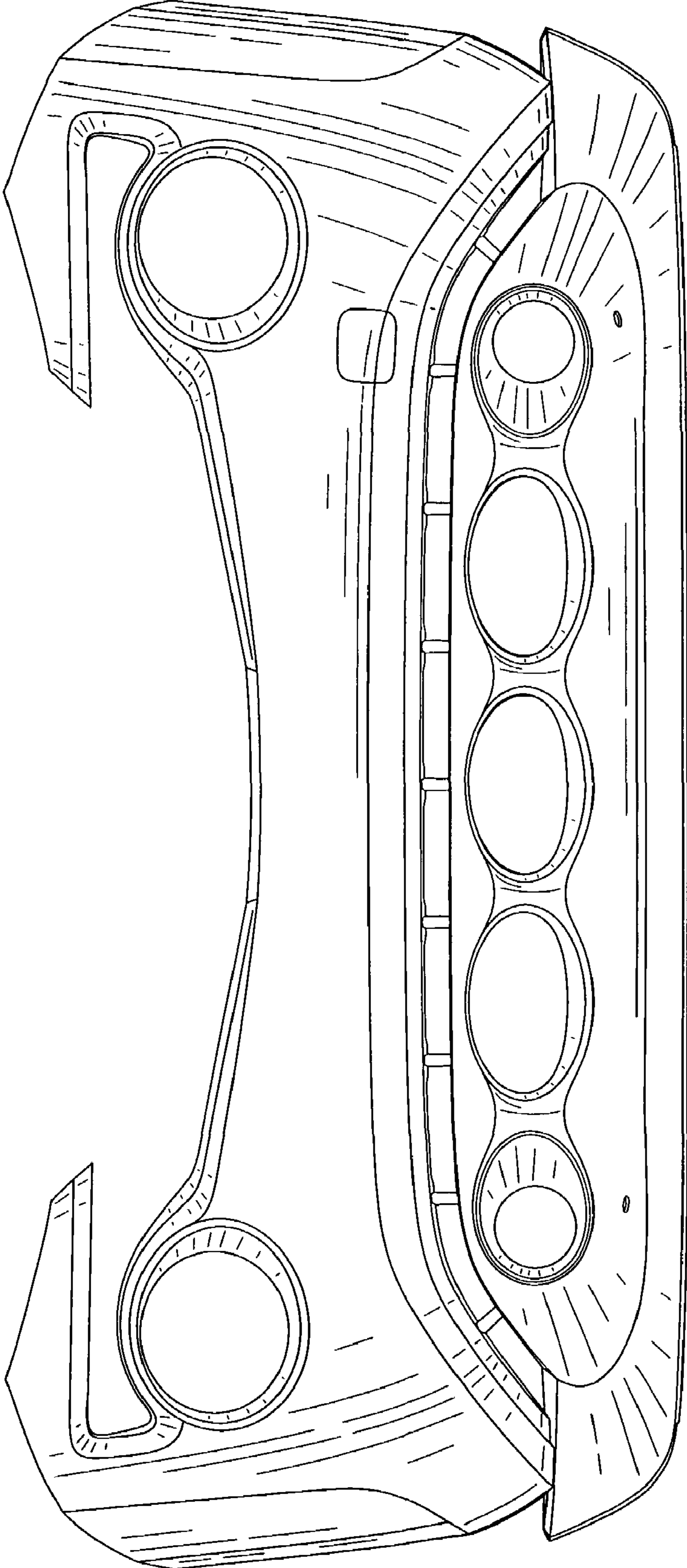

FIG. 2

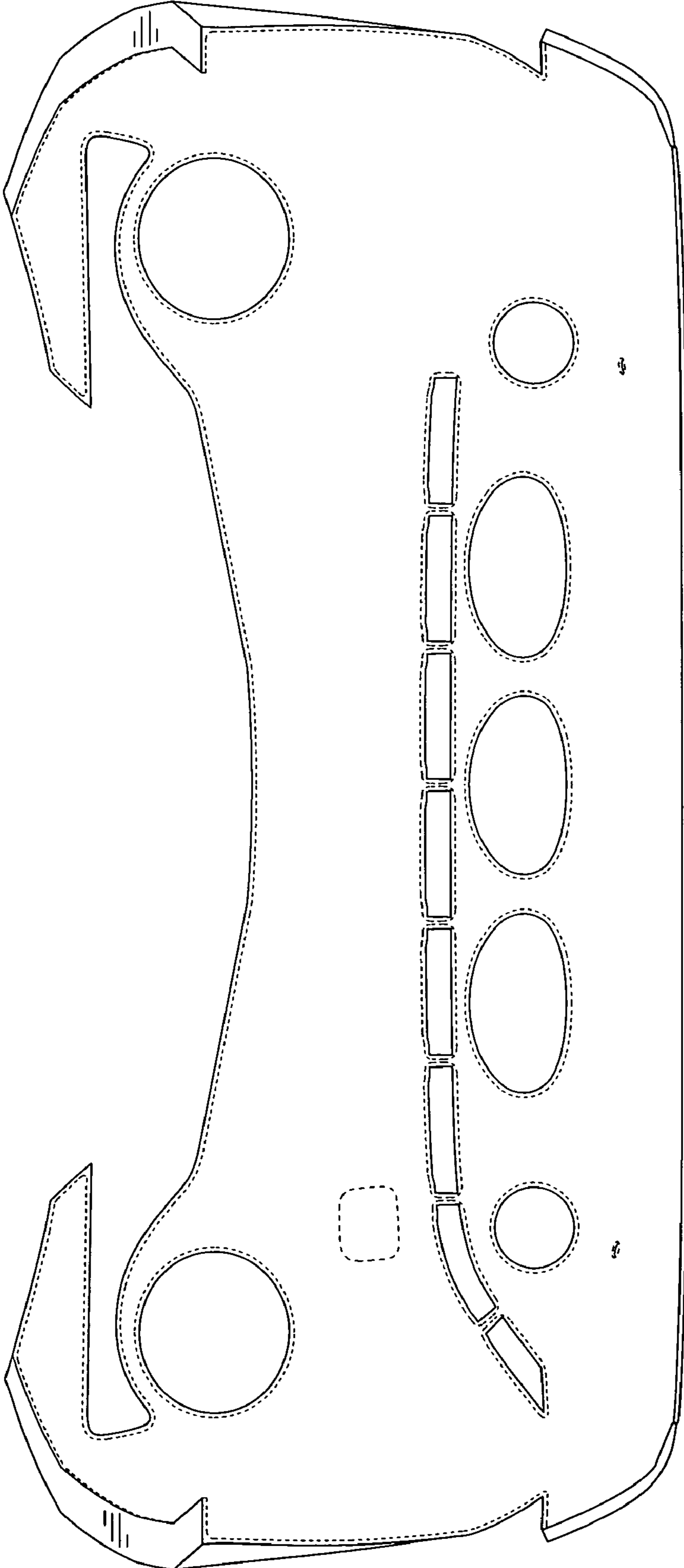
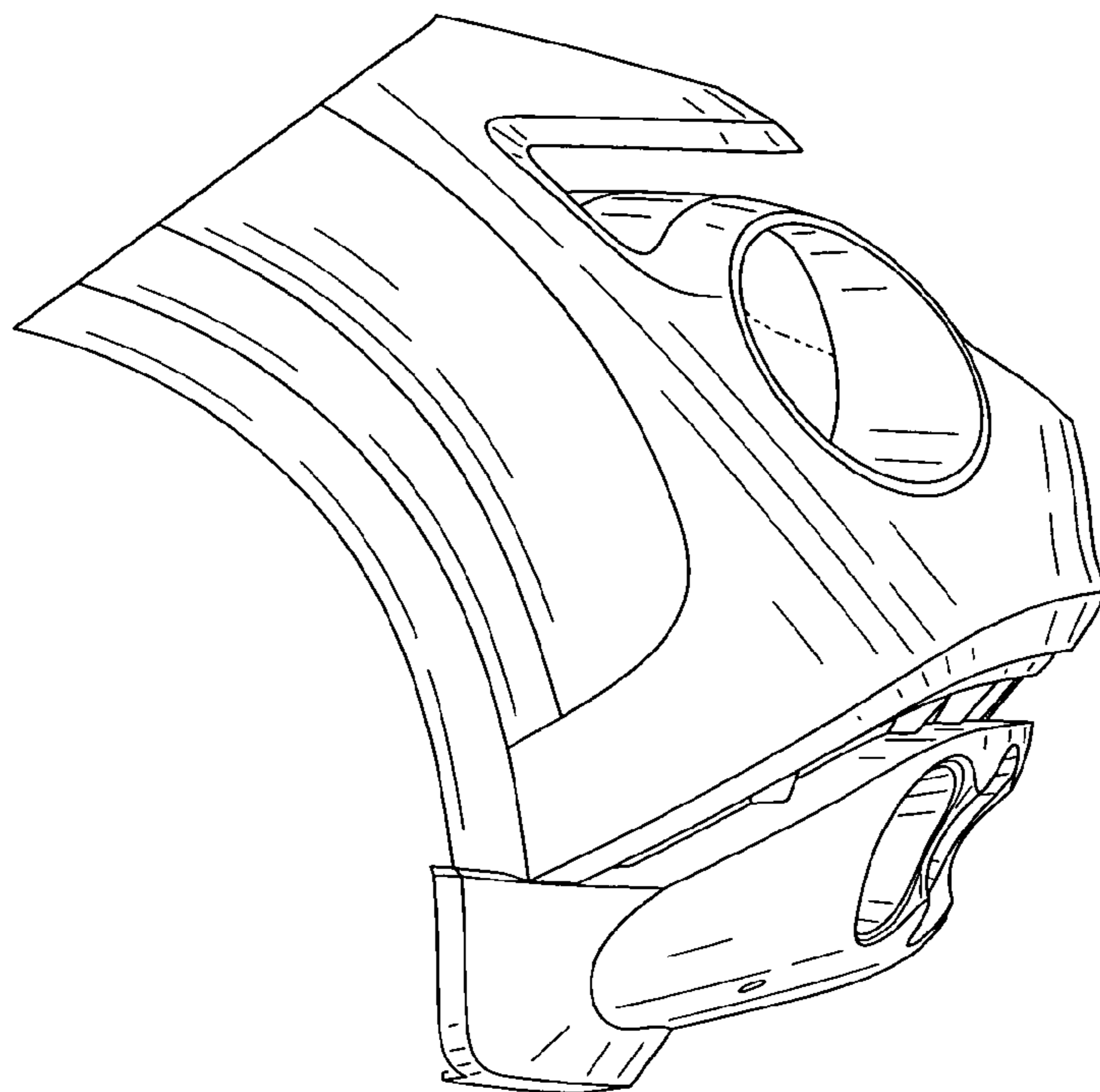
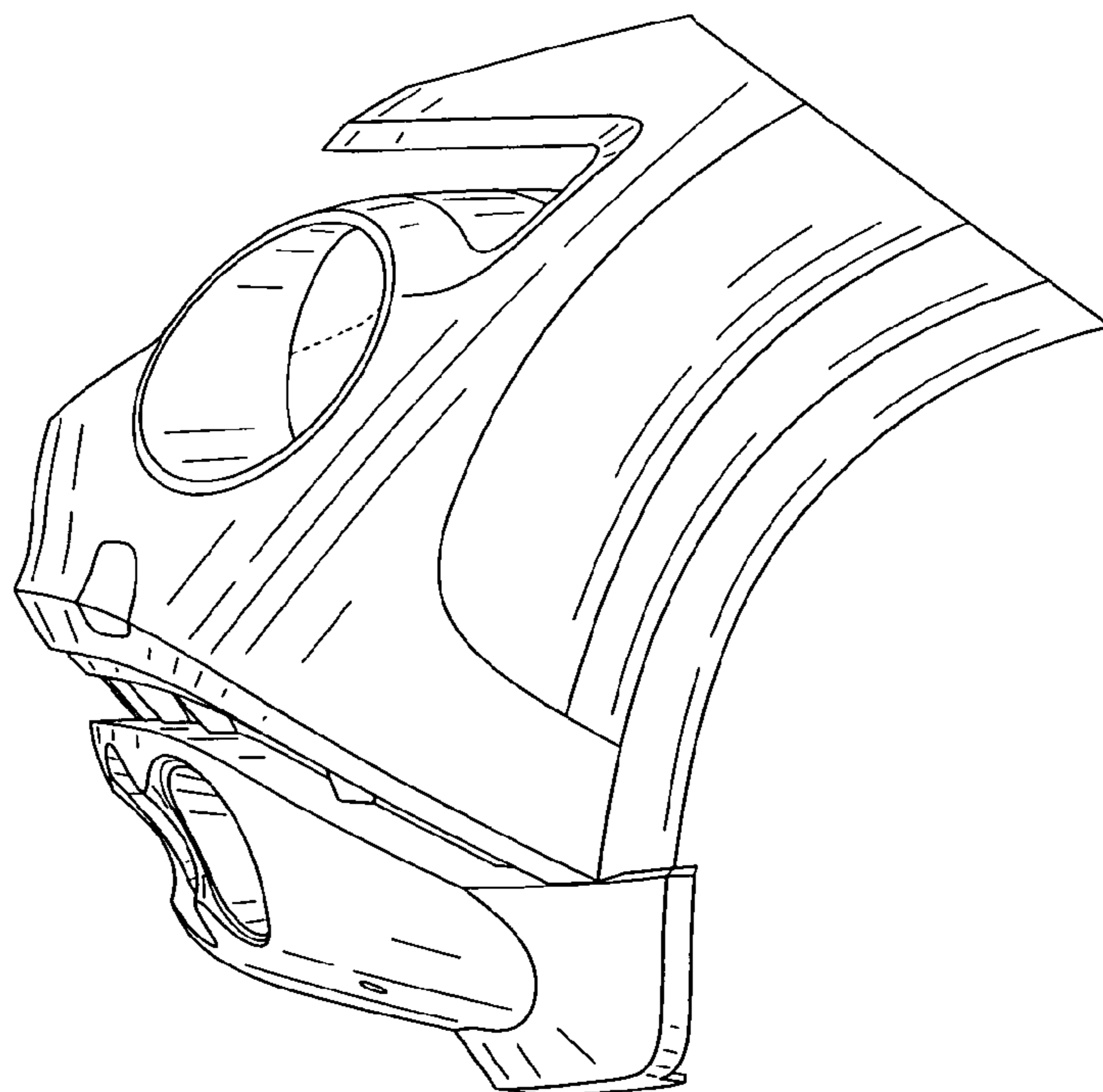

FIG. 3





**FIG. 4**



**FIG. 5**

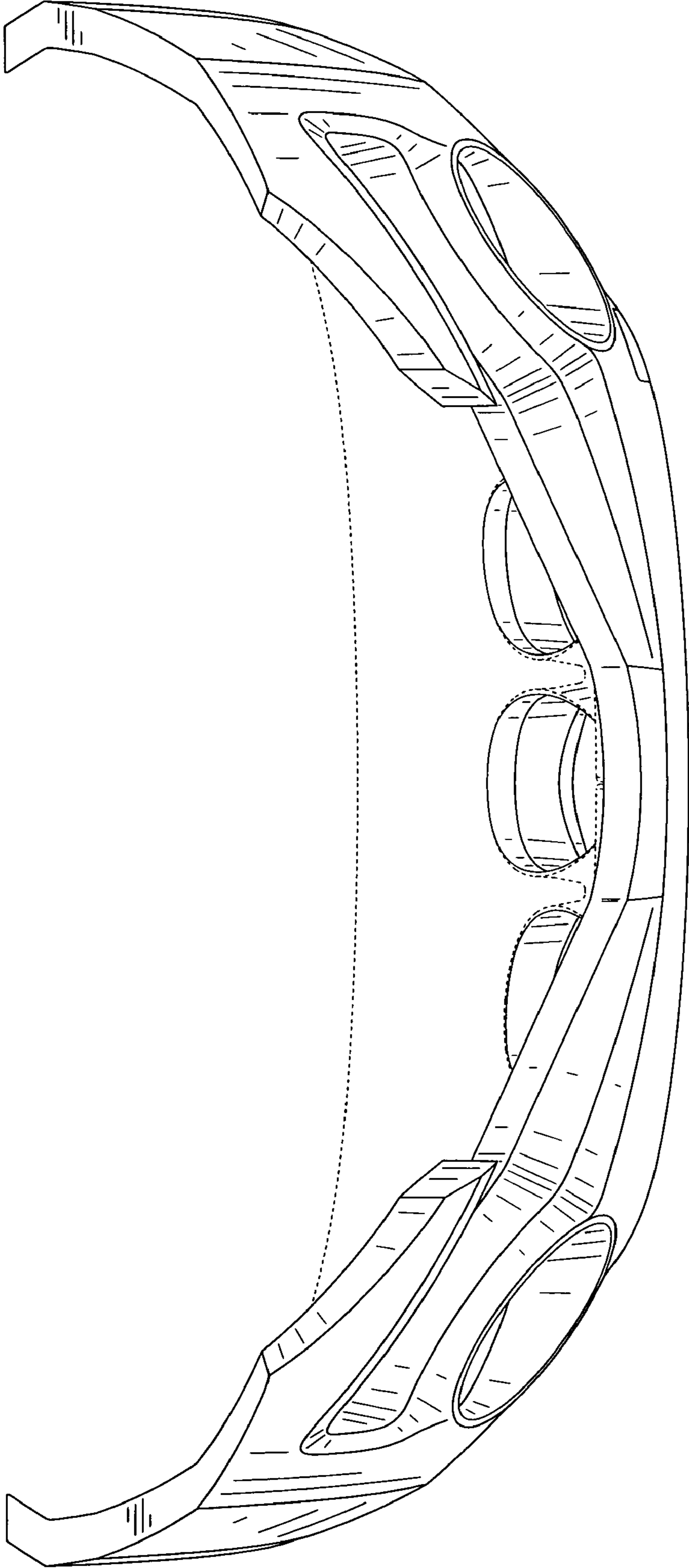

FIG. 6

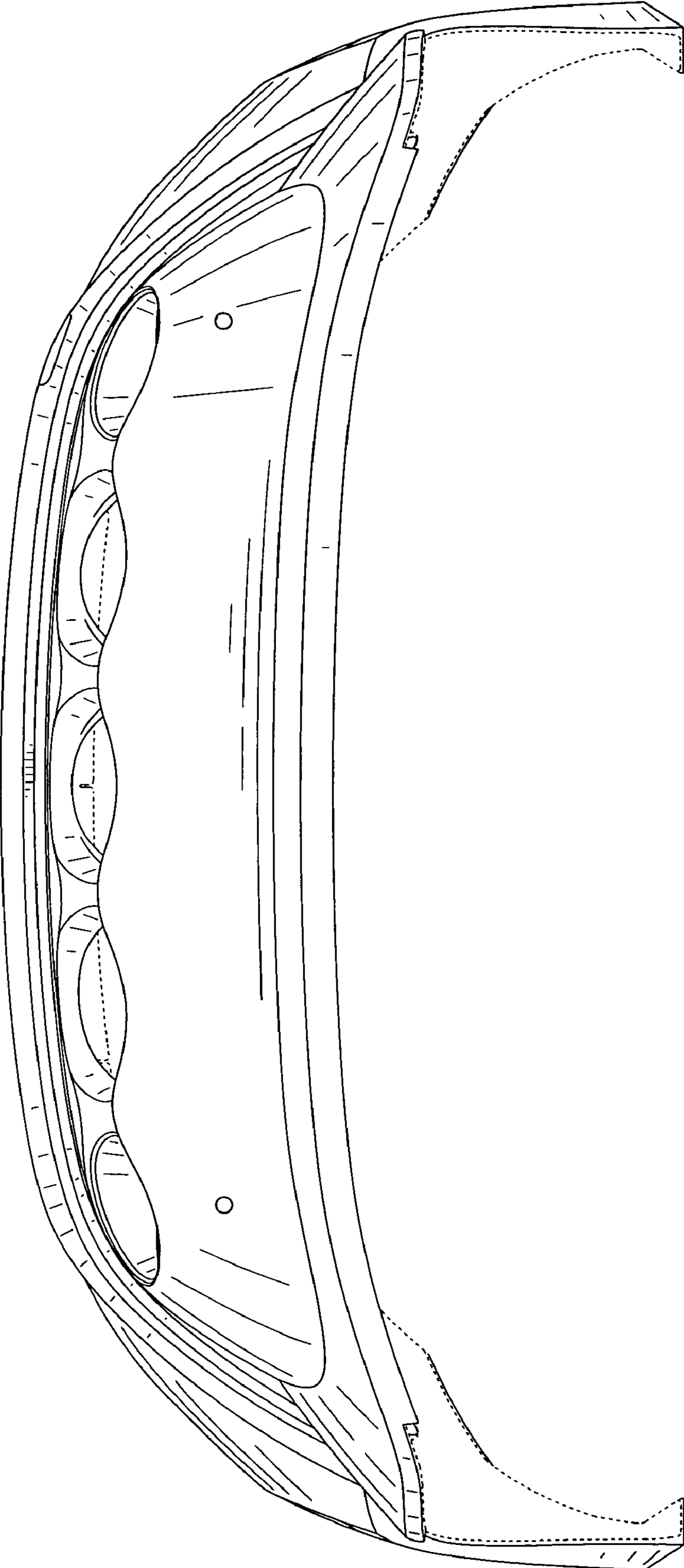

FIG. 7