



US00D614050S

(12) **United States Design Patent**
Diltoer

(10) **Patent No.:** **US D614,050 S**
(45) **Date of Patent:** **** Apr. 20, 2010**

(54) **WATCH**

(75) Inventor: **Jacques Diltoer**, La Garenne (FR)

(73) Assignee: **Cartier Creating Studio S.A.**, Geneva (CH)

(**) Term: **14 Years**

(21) Appl. No.: **29/342,005**

(22) Filed: **Aug. 17, 2009**

D371,081 S *	6/1996	Mijatovic	D10/39
D388,332 S *	12/1997	Perrin et al.	D10/32
D390,791 S *	2/1998	Kubisch	D10/39
D403,248 S *	12/1998	Magninat	D10/30
D413,526 S *	9/1999	Perrin et al.	D10/30
D432,438 S *	10/2000	Lassigne	D10/32
D472,159 S *	3/2003	Pequignet	D10/32
D474,700 S *	5/2003	Court	D10/39
D505,628 S *	5/2005	Scheufele	D10/39
D508,212 S *	8/2005	Scheufele	D10/39
D508,421 S *	8/2005	Diltoer	D10/39
D546,203 S *	7/2007	Campos	D10/32
D546,712 S *	7/2007	Arlanda	D10/32

Related U.S. Application Data

(63) Continuation of application No. 29/322,454, filed on Aug. 5, 2008, now Pat. No. Des. 600,144, which is a continuation of application No. 29/228,178, filed on Apr. 19, 2005, now Pat. No. Des. 577,612, which is a continuation of application No. 29/211,185, filed on Aug. 12, 2004, now Pat. No. Des. 508,421.

Foreign Application Priority Data

(30) Feb. 13, 2004 (EM) 000134531-005

(51) **LOC (9) Cl.** **10-02**

(52) **U.S. Cl.** **D10/38**

(58) **Field of Classification Search** D10/30-39;
368/276, 281, 282, 285

See application file for complete search history.

References Cited

U.S. PATENT DOCUMENTS

D259,186 S *	5/1981	Perrin	D10/32
D262,949 S *	2/1982	Perrin	D10/32
D265,980 S *	8/1982	Kanouï	D10/26
D267,478 S *	1/1983	Kanouï	D10/32
D267,549 S *	1/1983	Kanouï	D10/39
D268,332 S *	3/1983	Weil	D10/32
D277,649 S *	2/1985	Glauser	D10/32
D278,130 S *	3/1985	Houlihan et al.	D10/38
D280,885 S *	10/1985	Perrin	D10/32
D288,066 S *	2/1987	Kanouï	D10/32
D364,818 S *	12/1995	Chodat	D10/30
D370,854 S *	6/1996	Chodat	D10/30

OTHER PUBLICATIONS

Distance, Mar./Apr. 1983, "Les Must De Cartier" watches.*
Wristwatches, A Connoisseur's Guide, Frank Edwards, copyright 1997, Firefly Books, pp. 13 and 51, Carier watches.*
Swiss Watch and Jewelry Journal, Feb. 1981, p. 285, Golana watch, item # 1711.*
Cartier Catalog, 2000, pp. 33, 52, 60 and 67.*

* cited by examiner

Primary Examiner—Lucy Lieberman

(74) *Attorney, Agent, or Firm*—Kalow & Springut, LLP; Scott D. Locke, Esq.

(57) **CLAIM**

The ornamental design for a watch, as shown and described.

DESCRIPTION

FIG. 1 is a perspective view of the watch;

FIG. 2 is a front view thereof;

FIG. 3 is a rear view thereof;

FIG. 4 is a right-side view thereof;

FIG. 5 is a left-side view thereof;

FIG. 6 is a top view; and,

FIG. 7 is a bottom view thereof.

The broken lines are for illustrative purposes only and form no part of the claimed design.

1 Claim, 3 Drawing Sheets

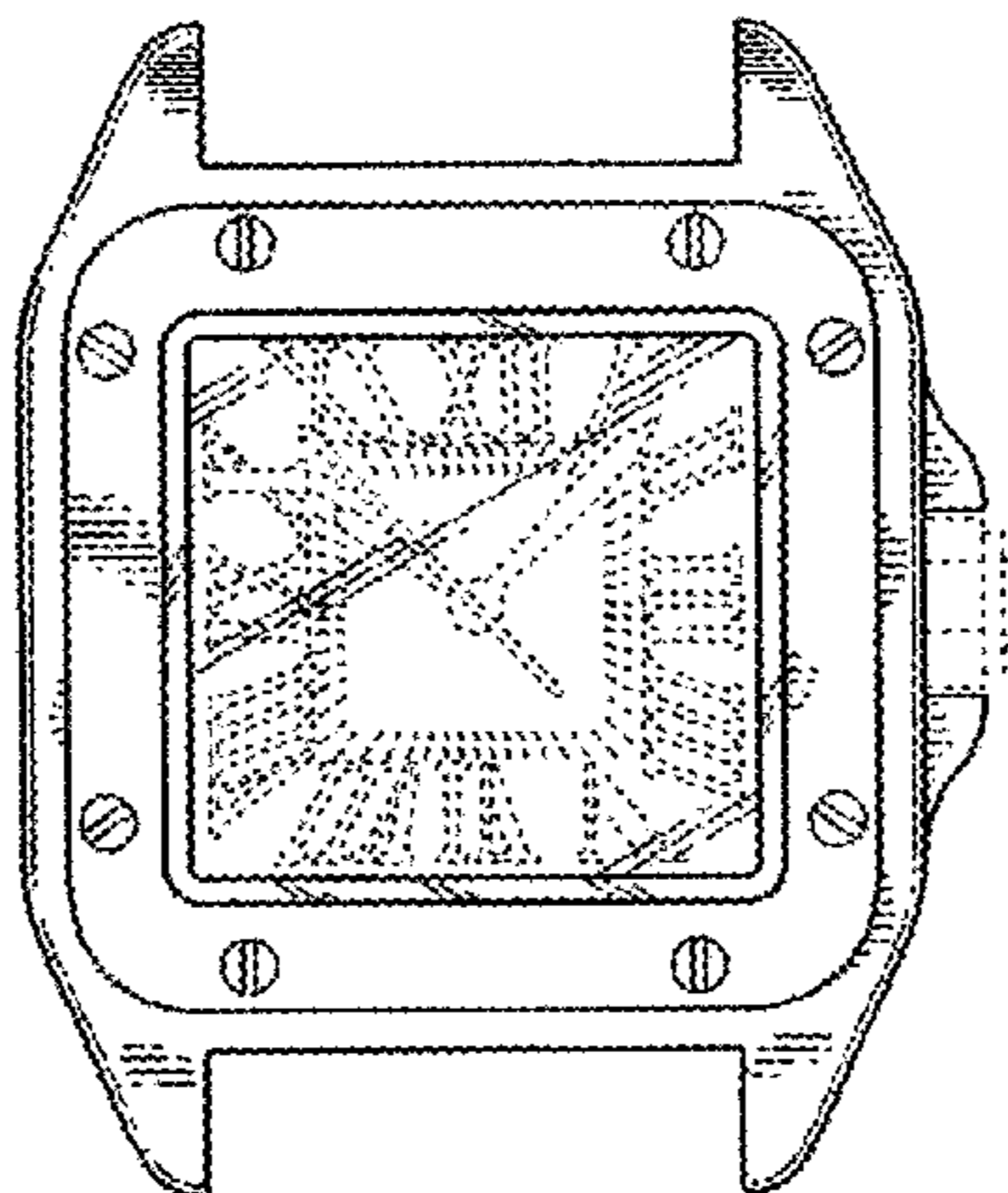

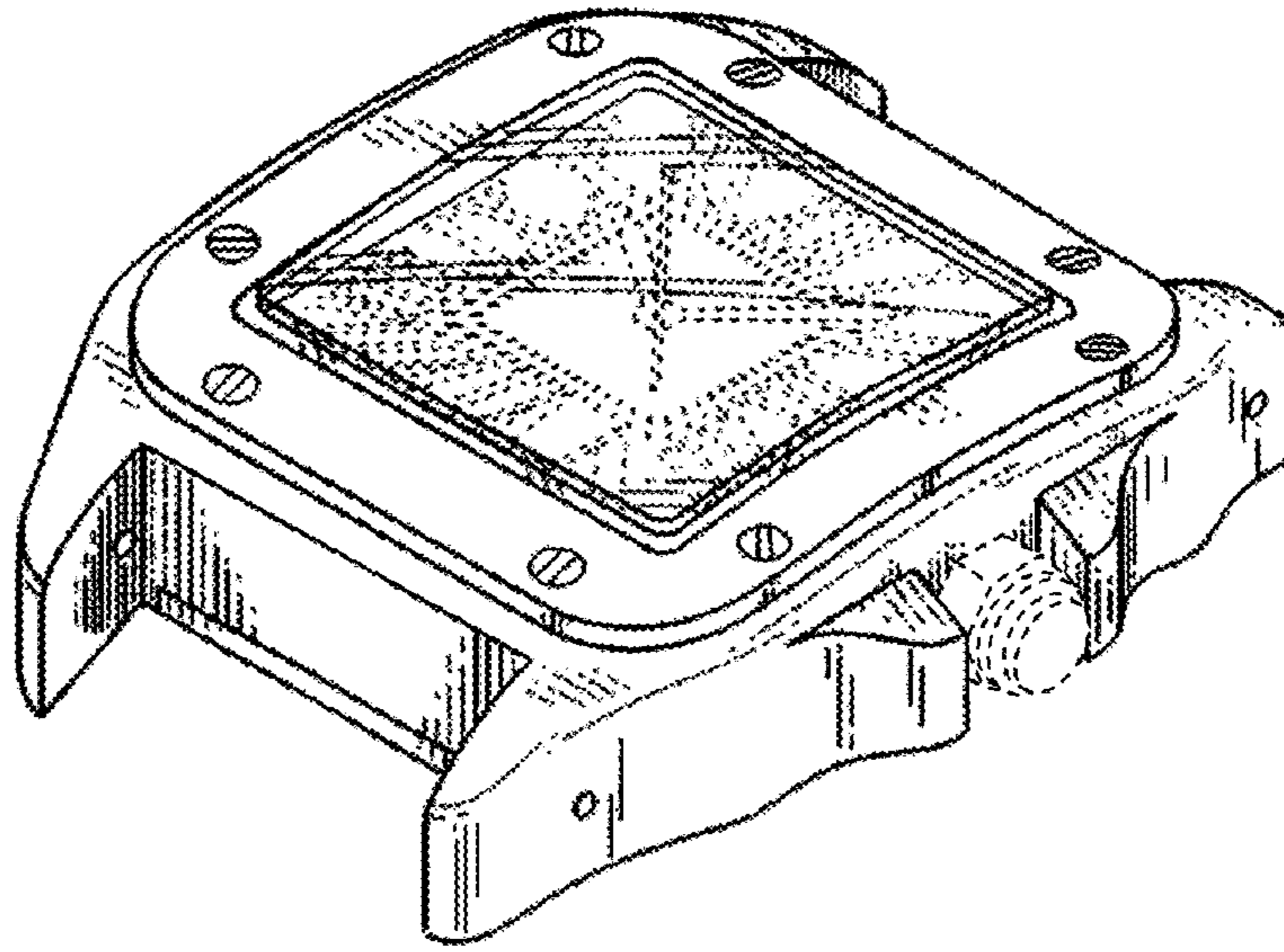

FIG. 1

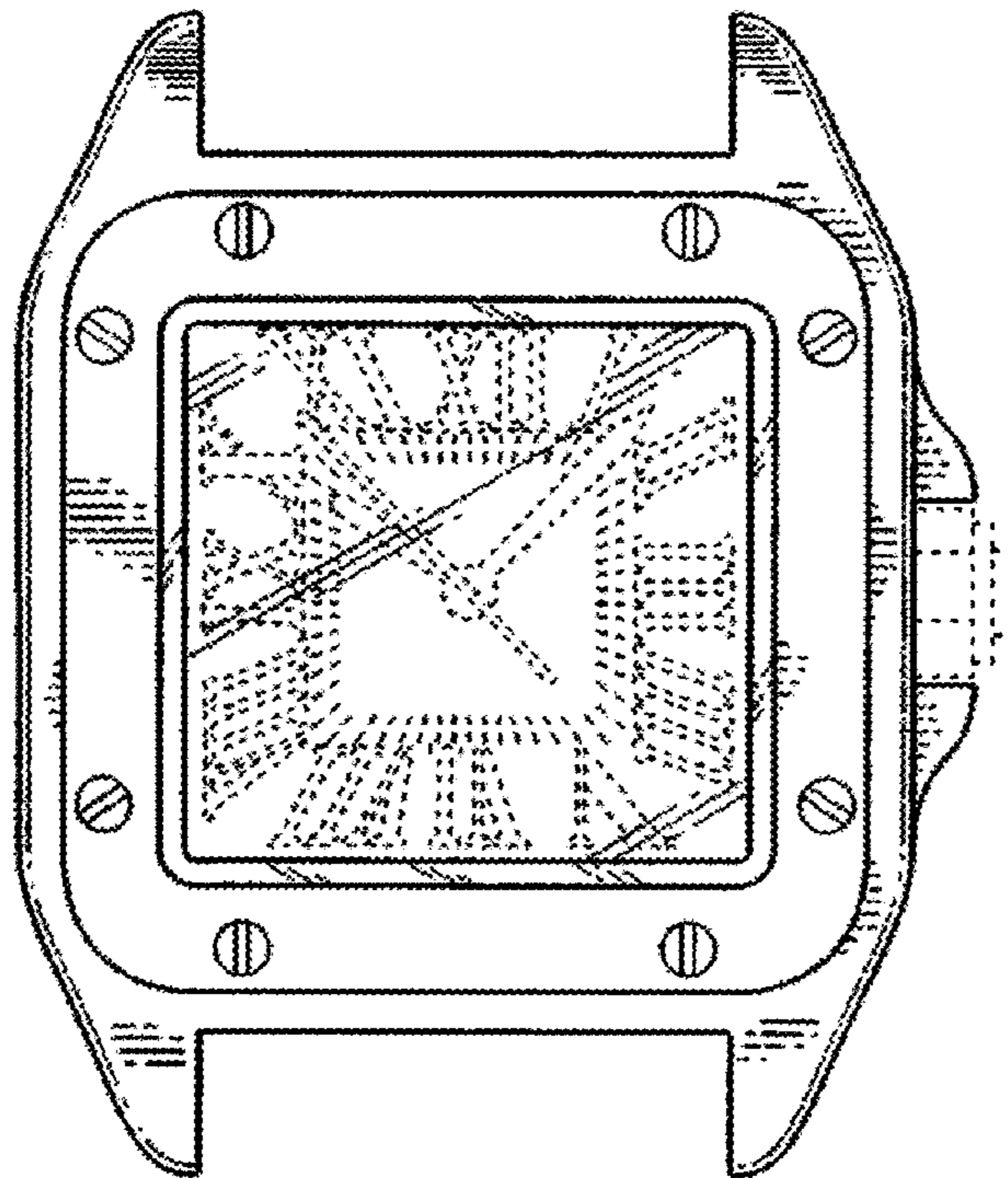

FIG. 2

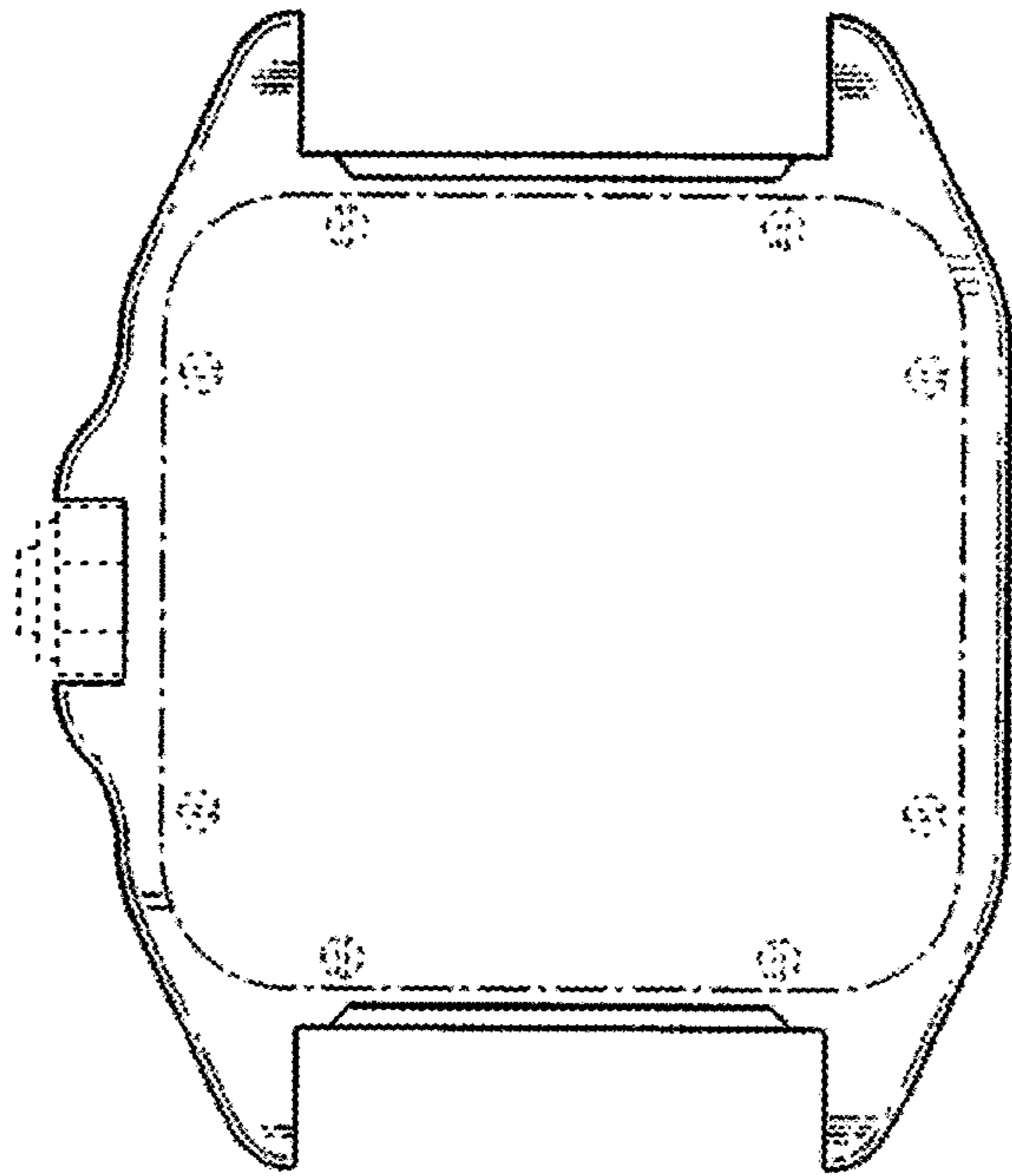

FIG. 3

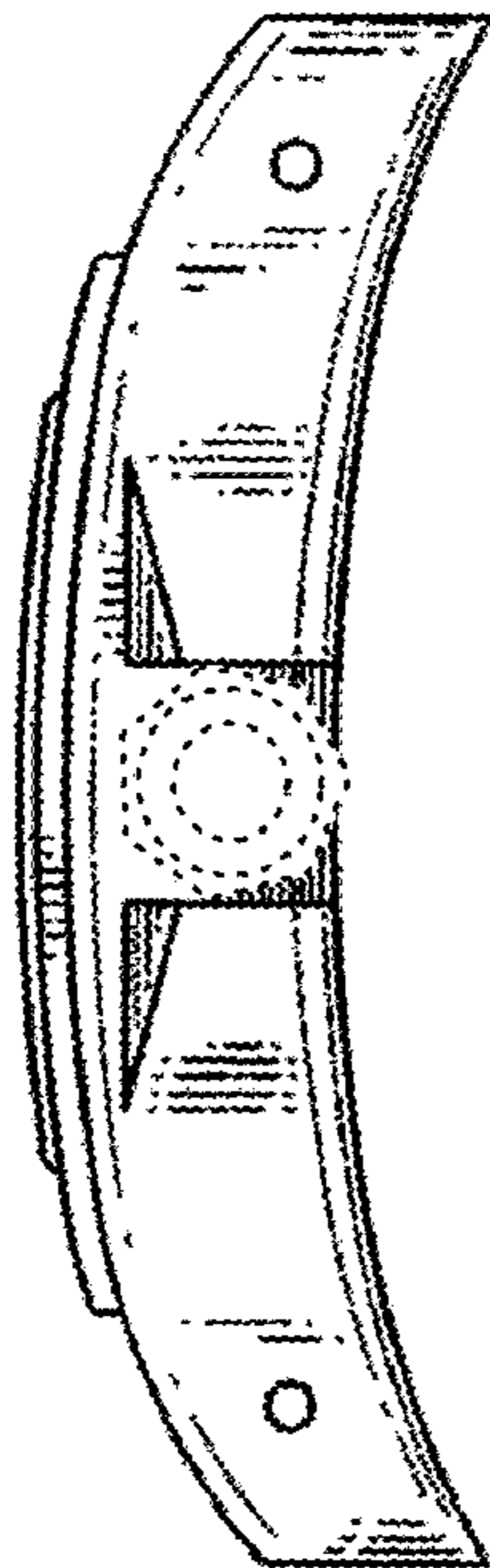

FIG. 4

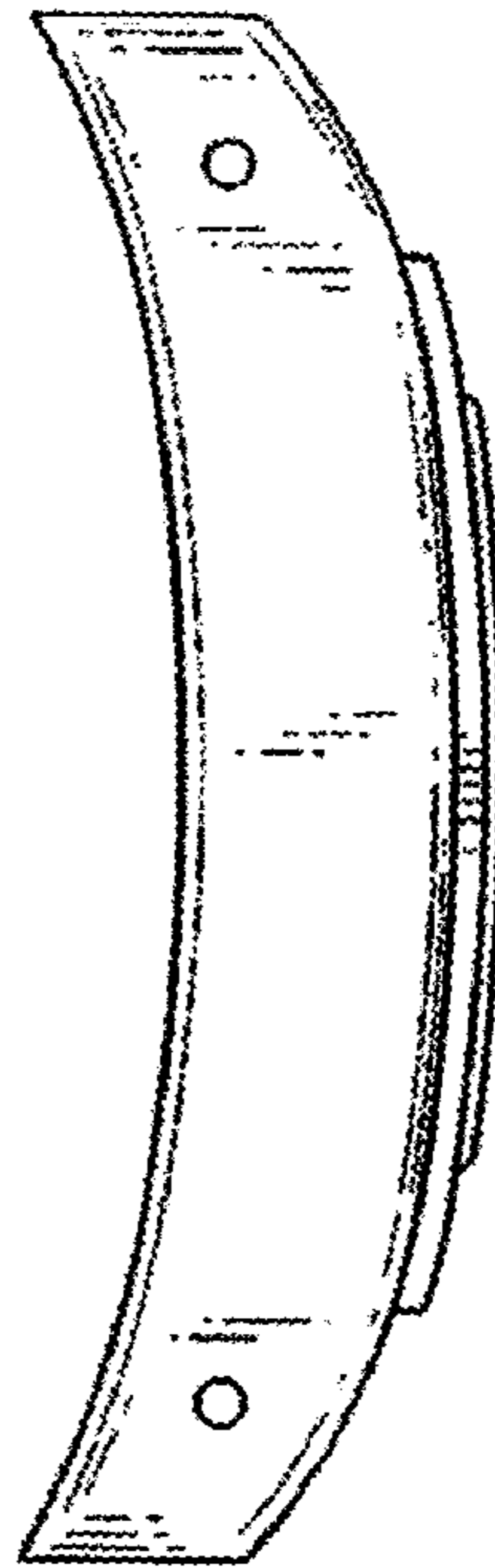

FIG. 5

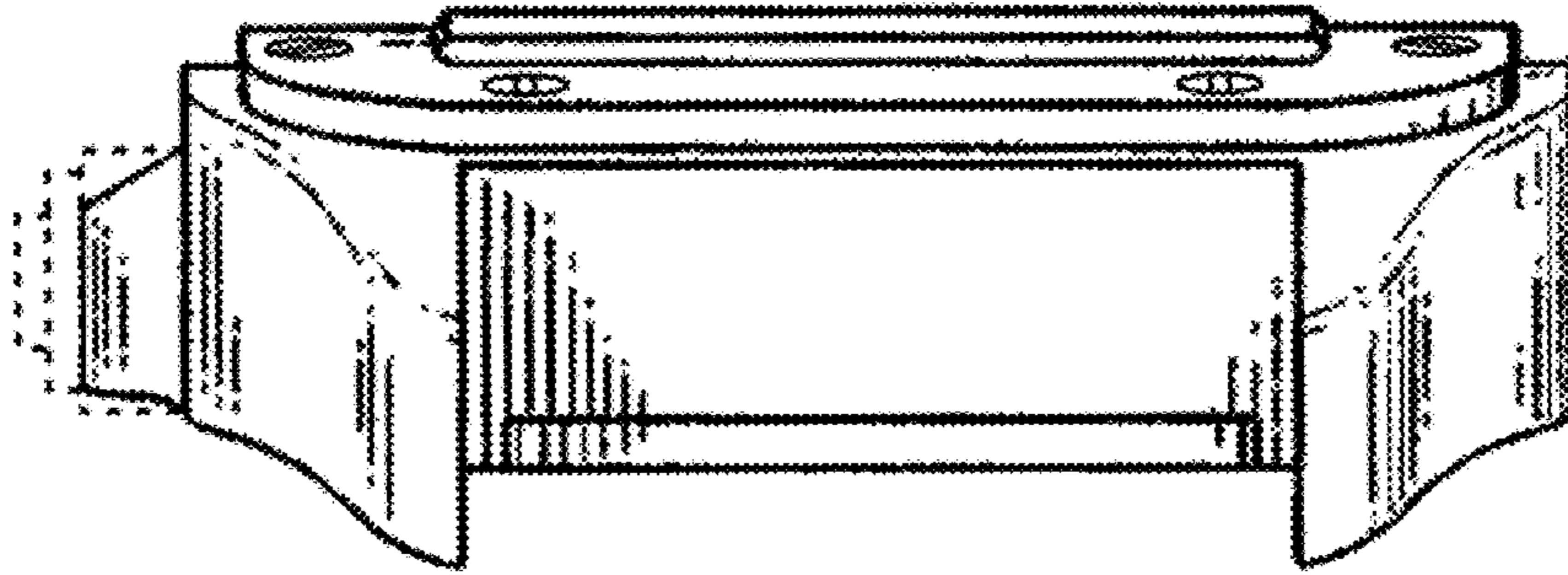

FIG. 6

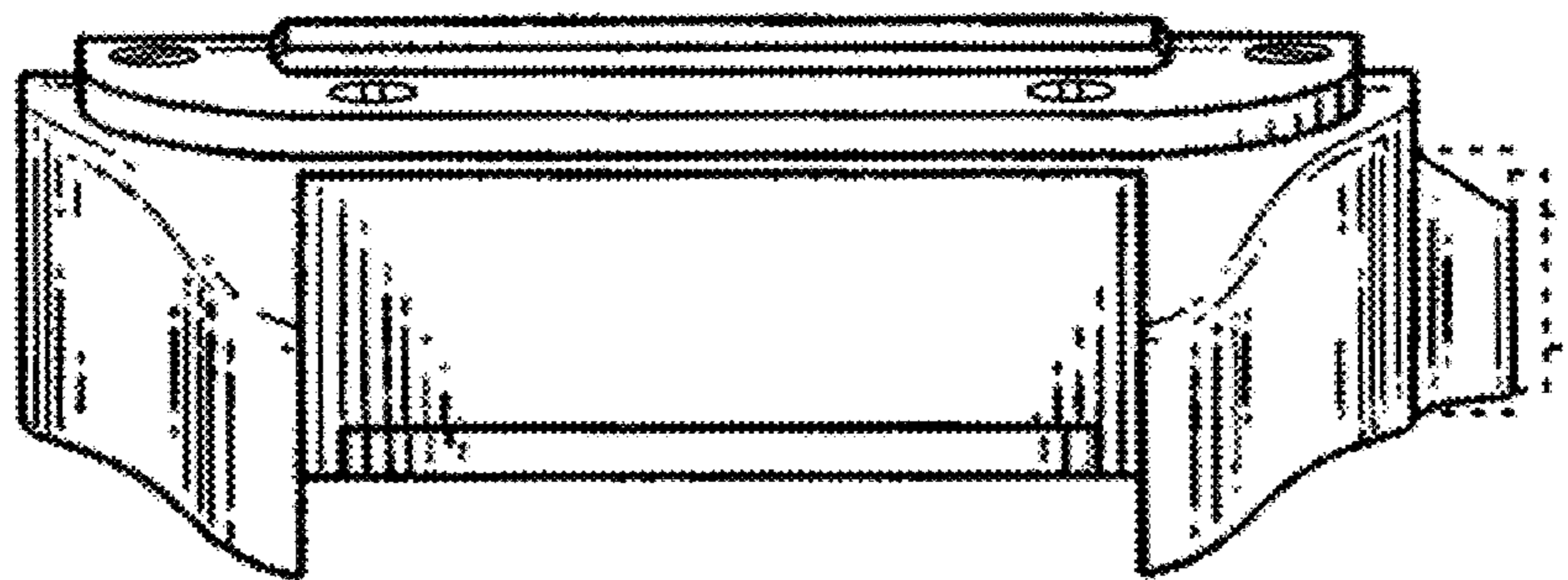

FIG. 7