



US00D613975S

(12) **United States Design Patent**  
**Davis**

(10) **Patent No.:** **US D613,975 S**  
(45) **Date of Patent:** **\*\* Apr. 20, 2010**

(54) **DESK**

D503,054 S \* 3/2005 Olson ..... D6/499

(76) Inventor: **Bradford L. Davis**, 15151 Buchanan,  
West Olive, MI (US) 49460

\* cited by examiner

*Primary Examiner*—Janice E Seeger  
(74) *Attorney, Agent, or Firm*—Warner Norcross & Judd LLP

(\*\*) Term: **14 Years**

(21) Appl. No.: **29/338,369**

(57) **CLAIM**

(22) Filed: **Jun. 10, 2009**

The ornamental design for desk, as shown and described.

(51) **LOC (9) Cl.** ..... **06-06**

**DESCRIPTION**

(52) **U.S. Cl.** ..... **D6/499; D6/483; D6/487**

FIG. 1 is a perspective view of the desk embodying my new design;

(58) **Field of Classification Search** ..... D6/480–489,  
D6/429–431, 495–499, 511; 108/150, 152,  
108/153.1, 157.1, 161; 248/188, 188.1, 188.7,  
248/188.8

FIG. 2 is a top plan view thereof;

FIG. 3 is a bottom plan view thereof;

See application file for complete search history.

FIG. 4 is a front elevational view thereof;

FIG. 5 is a rear elevational view thereof; and,

(56) **References Cited**

**U.S. PATENT DOCUMENTS**

FIG. 6 is a right side elevational view thereof, the left side  
elevational view being a mirror image thereof.

D169,868	S	*	6/1953	Schwartz	.....	D6/484
3,847,433	A	*	11/1974	Acton et al.	.....	297/239
D239,898	S	*	5/1976	Kirshenbaum	.....	D6/499
D395,765	S	*	7/1998	Preisig	.....	D6/372
D396,971	S	*	8/1998	Svensson	.....	D6/429

FIGS. 1–6 show portions of the desk in broken lines. The broken line portions are shown for environmental purposes and form no part of the claimed design.

**1 Claim, 6 Drawing Sheets**

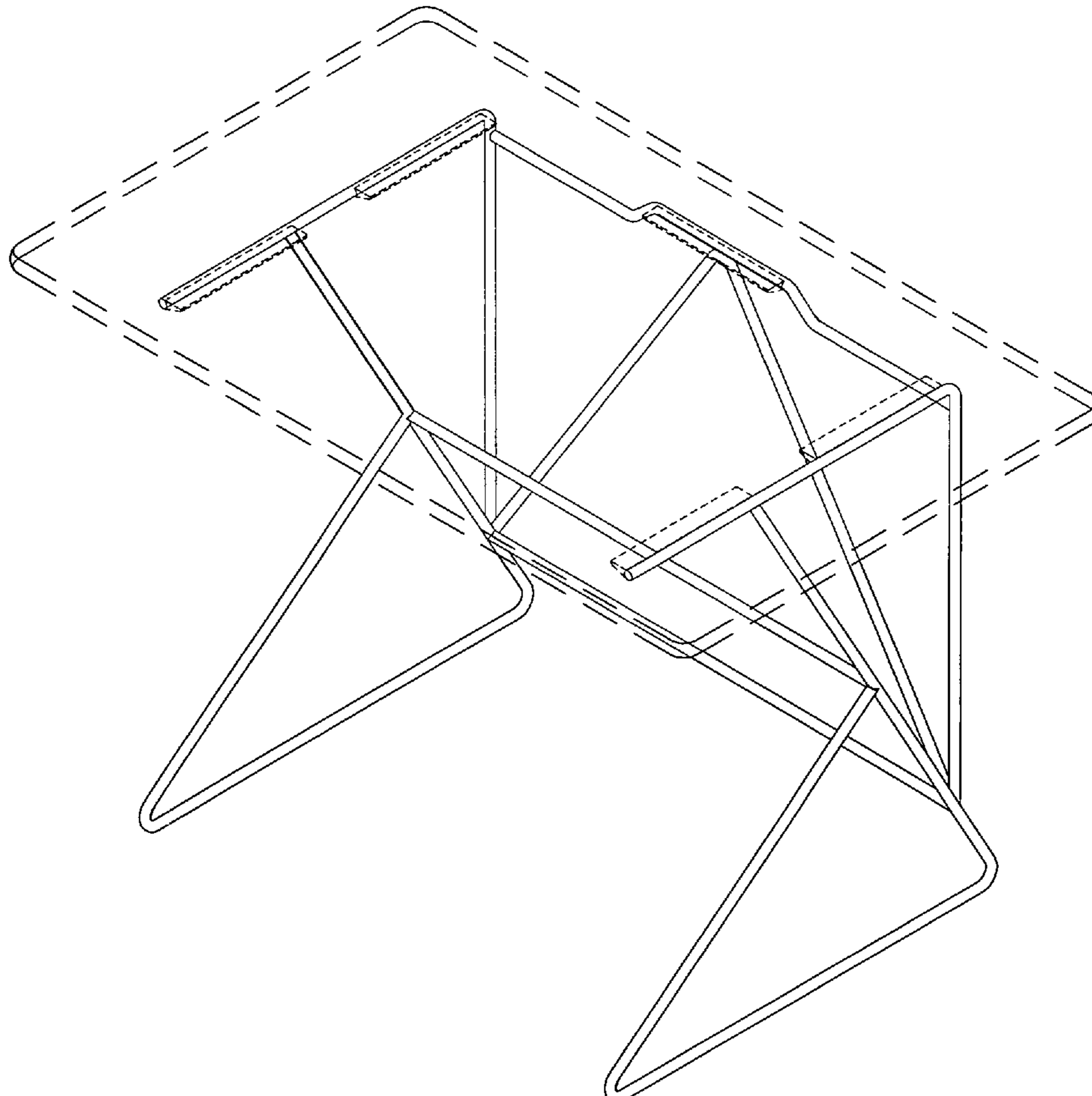

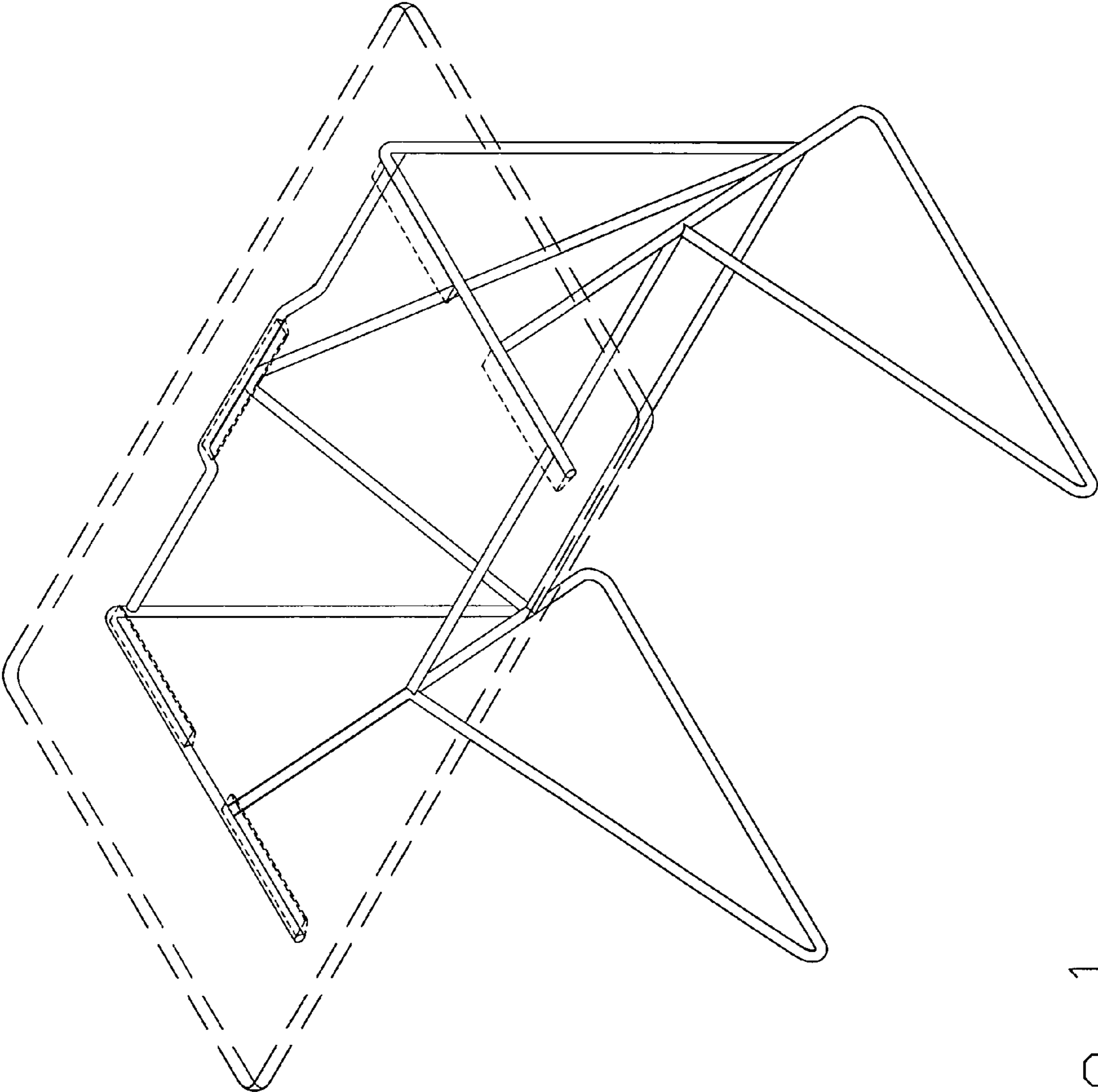

Fig. 1

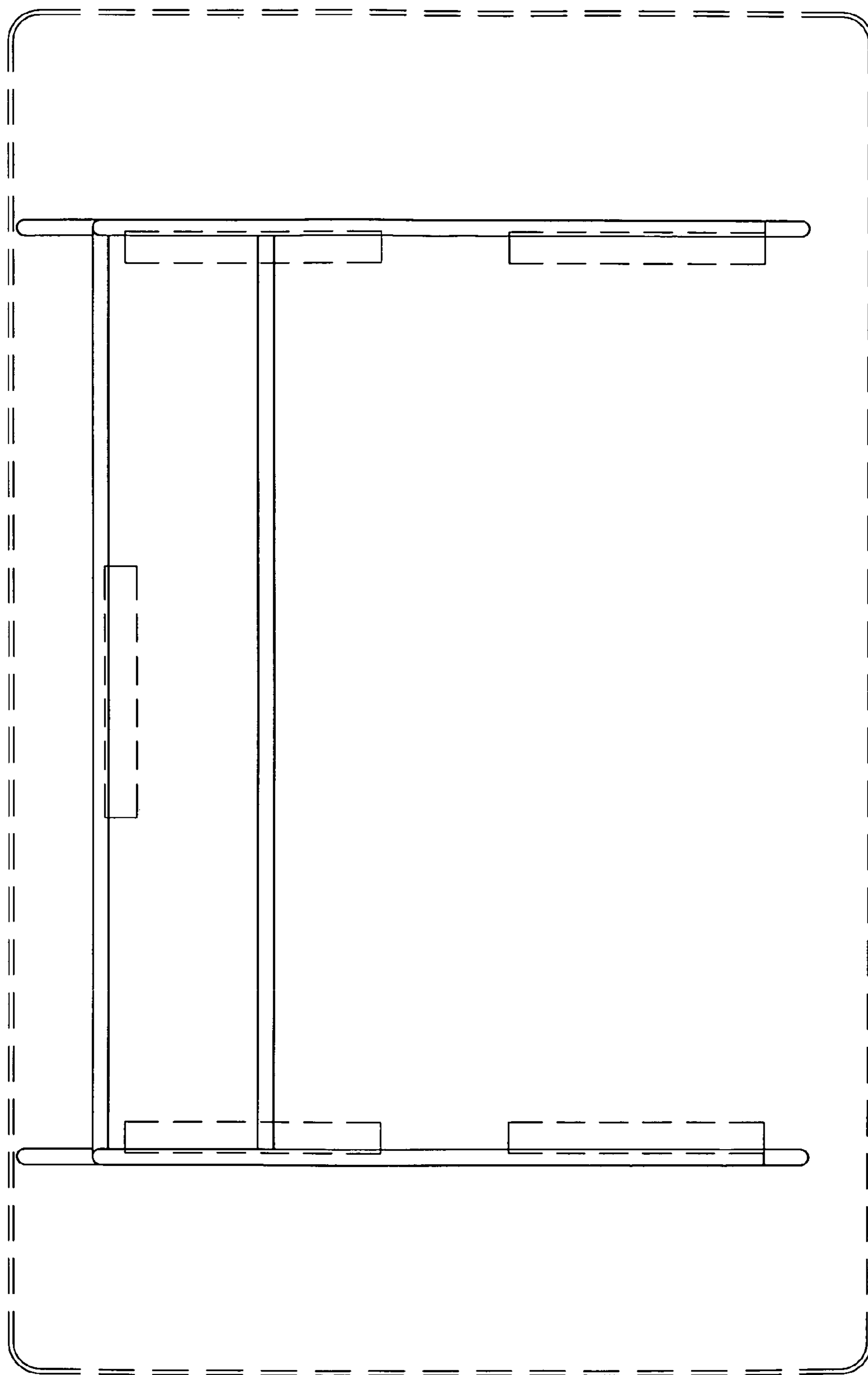

Fig. 2

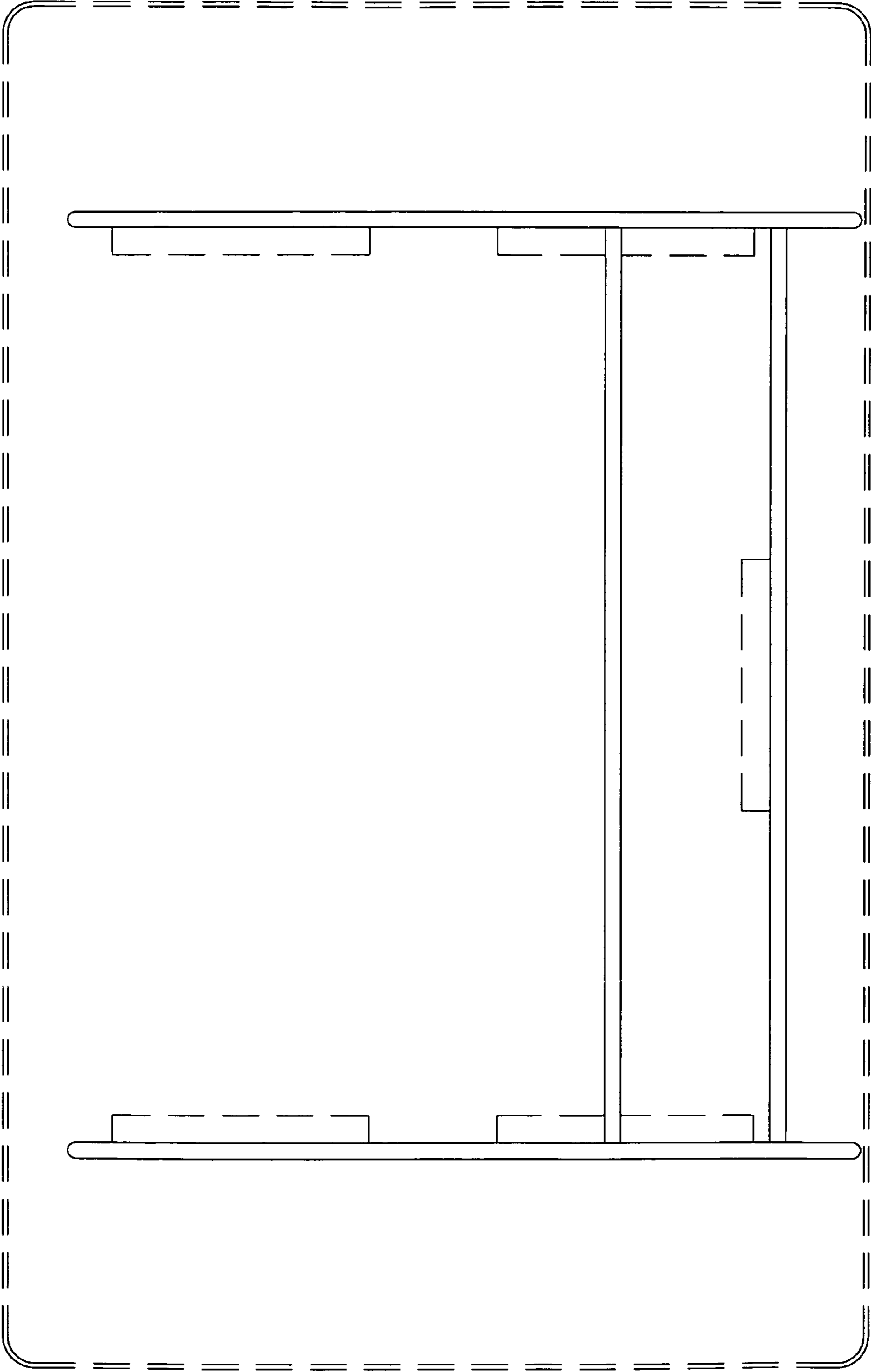

FIG. 3

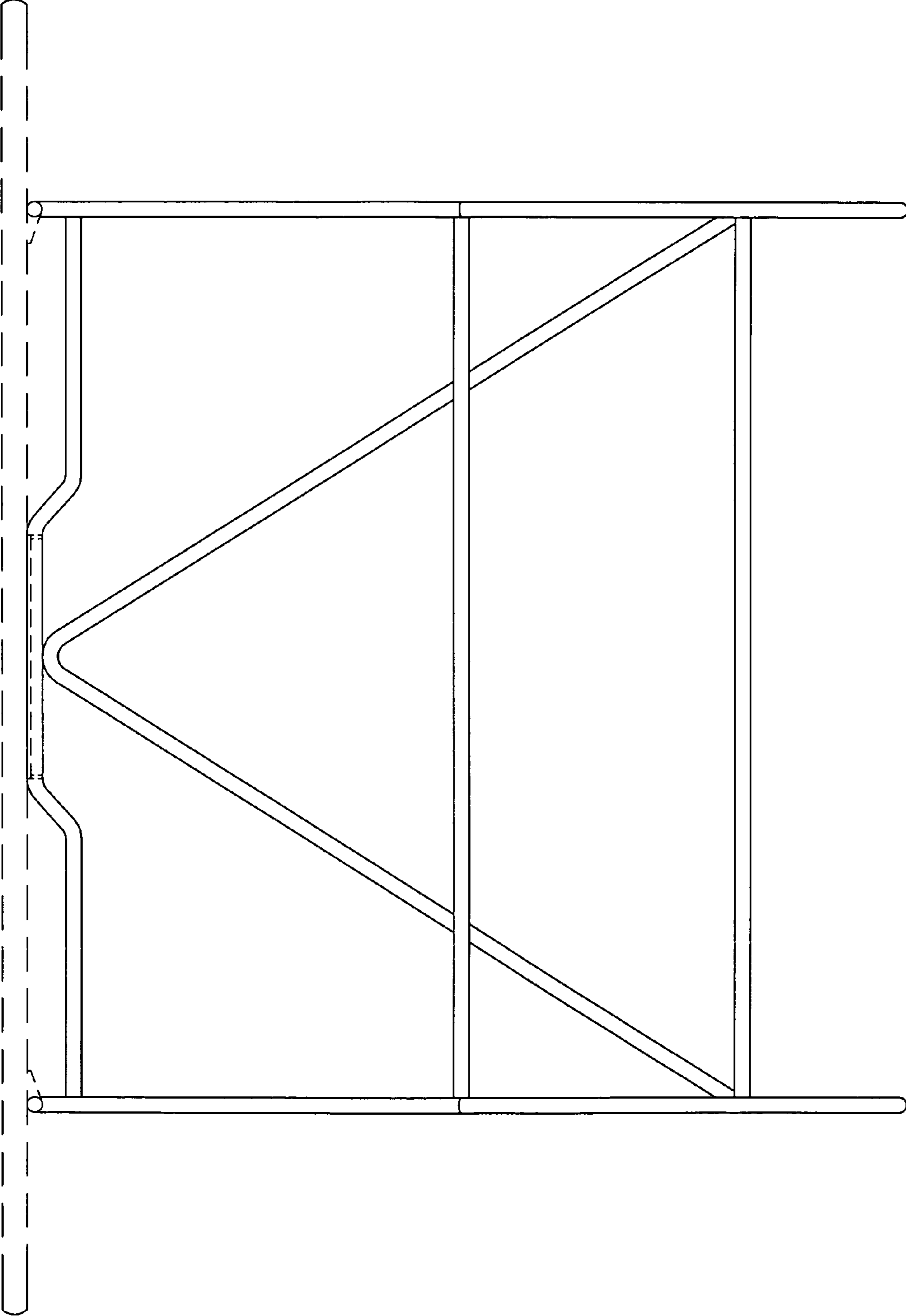

FIG. 4

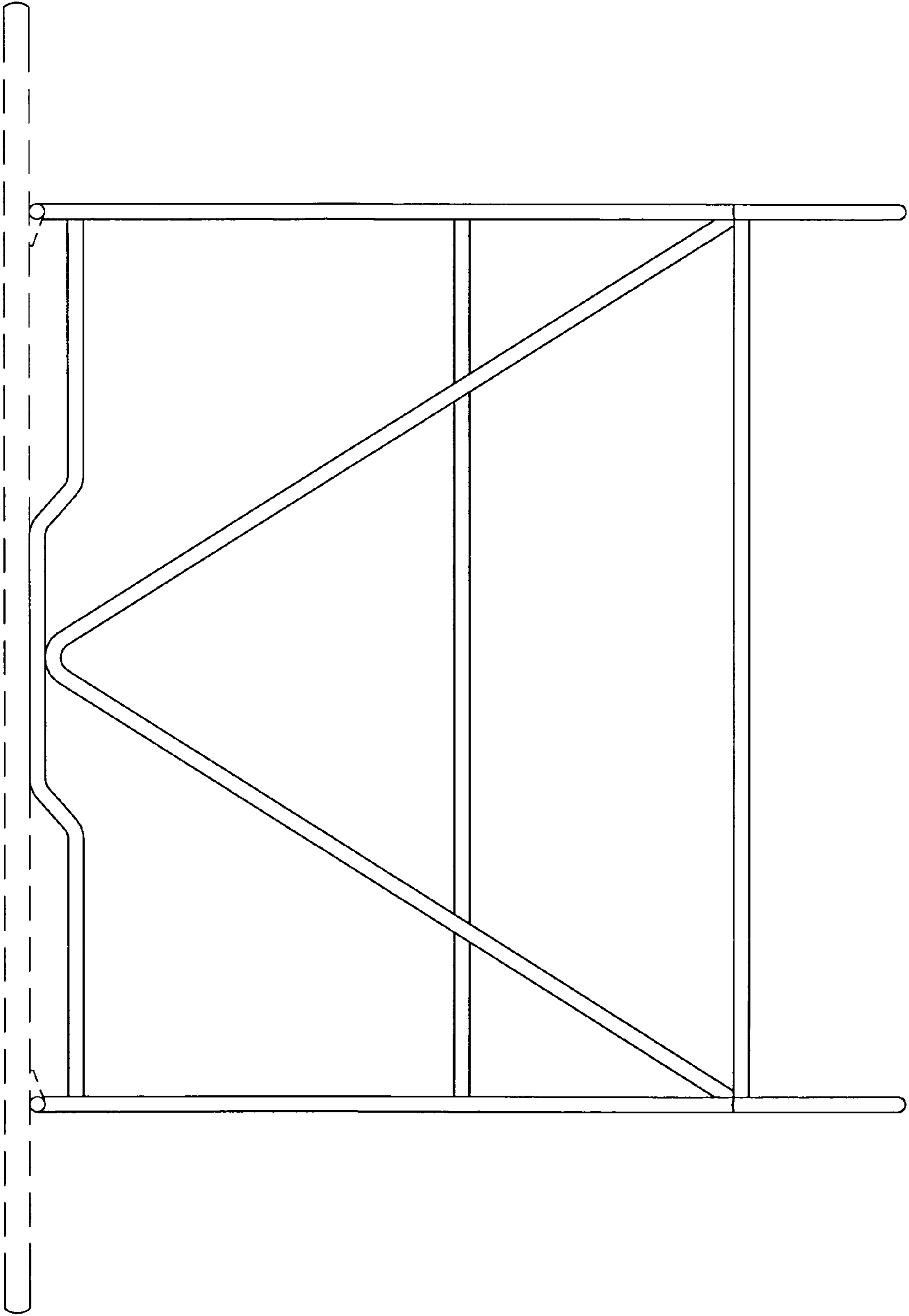

Fig. 5

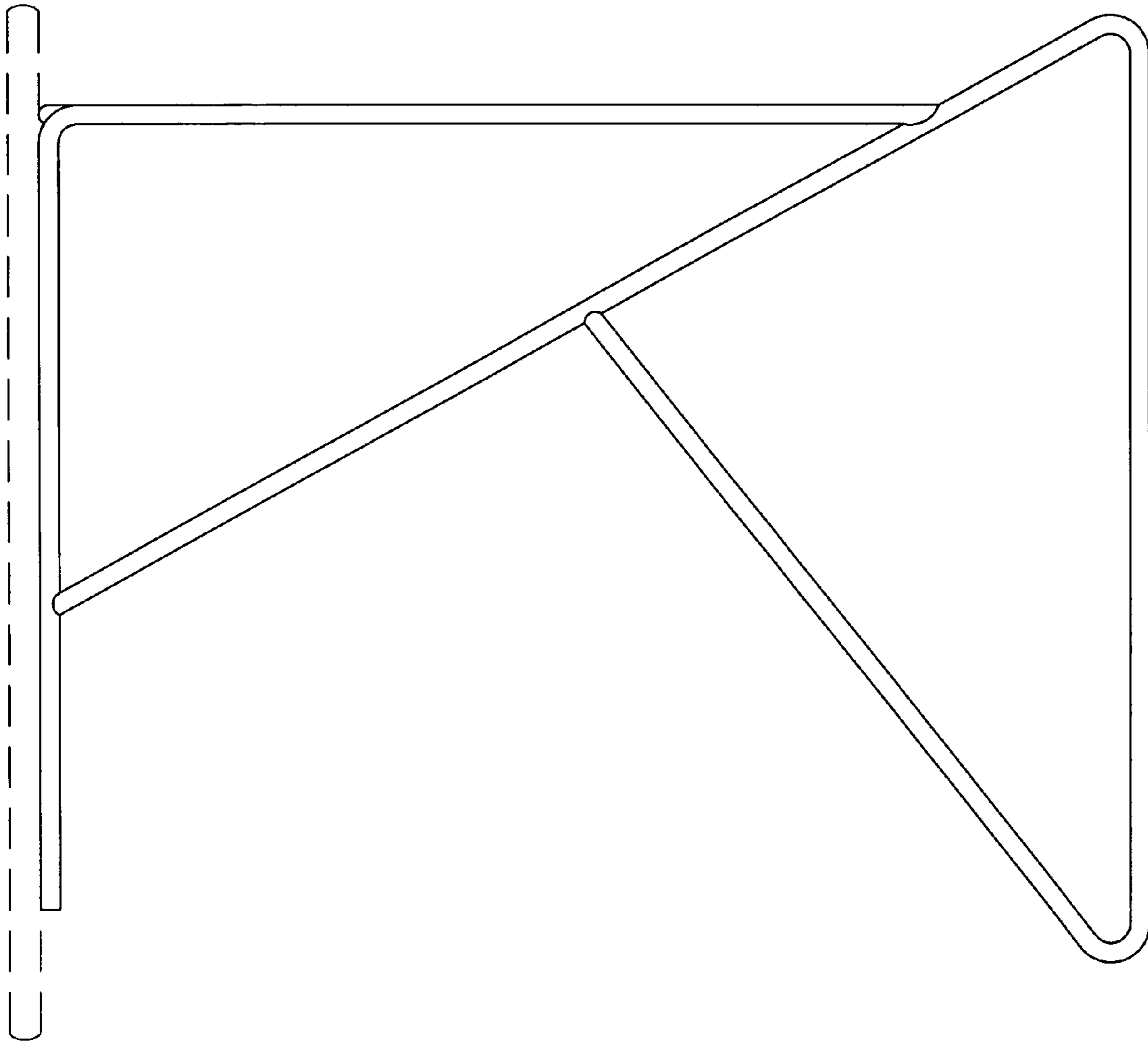

Fig. 6