



US00D613959S

(12) **United States Design Patent**
Crockett

(10) **Patent No.:** **US D613,959 S**

(45) **Date of Patent:** **** Apr. 20, 2010**

(54) **SEAT**

(75) Inventor: **David Crockett**, Saltillo, MS (US)

(73) Assignee: **Southern Motion, Inc.**, Pontotoc, MS (US)

(**) Term: **14 Years**

(21) Appl. No.: **29/335,648**

(22) Filed: **Apr. 17, 2009**

(51) **LOC (9) Cl.** **06-01**

(52) **U.S. Cl.** **D6/381**

(58) **Field of Classification Search** D6/334,
D6/349, 355, 359, 369, 370, 371, 381-383,
D6/491, 492, 500-503; 297/94, 181, 233,
297/234, 235, 283.2, 311, 351, 353, 354.1,
297/354.12, 354.13, 445.1, 451.1, 451.8,
297/451.9; 5/12.1, 12.2

See application file for complete search history.

(56) **References Cited**

U.S. PATENT DOCUMENTS

D325,476 S * 4/1992 Wilson et al. D6/367
D376,265 S * 12/1996 Lewis et al. D6/334
D381,819 S * 8/1997 Lewis et al. D6/334

D390,372 S * 2/1998 Lewis et al. D6/381
D414,347 S * 9/1999 Lewis et al. D6/334
D525,803 S * 8/2006 Peacock D6/381
D555,387 S * 11/2007 Peacock D6/381

* cited by examiner

Primary Examiner—Sandra Snapp

(74) *Attorney, Agent, or Firm*—Bradley Arant Boulton
Cummings, LLP; T. Gregory Peterson; Jeremy A. Smith

(57) **CLAIM**

The ornamental design for a seat, as shown and described.

DESCRIPTION

FIG. 1 is a perspective view of the seat showing the new design in a first embodiment.

FIG. 2 is a top view thereof.

FIG. 3 is a front elevation view thereof.

FIG. 4 is a perspective view of the seat showing the new design in an alternative embodiment.

FIG. 5 is a top view thereof; and,

FIG. 6 is a front elevation view thereof.

The broken lines shown in the drawings are understood to represent stitching.

1 Claim, 6 Drawing Sheets

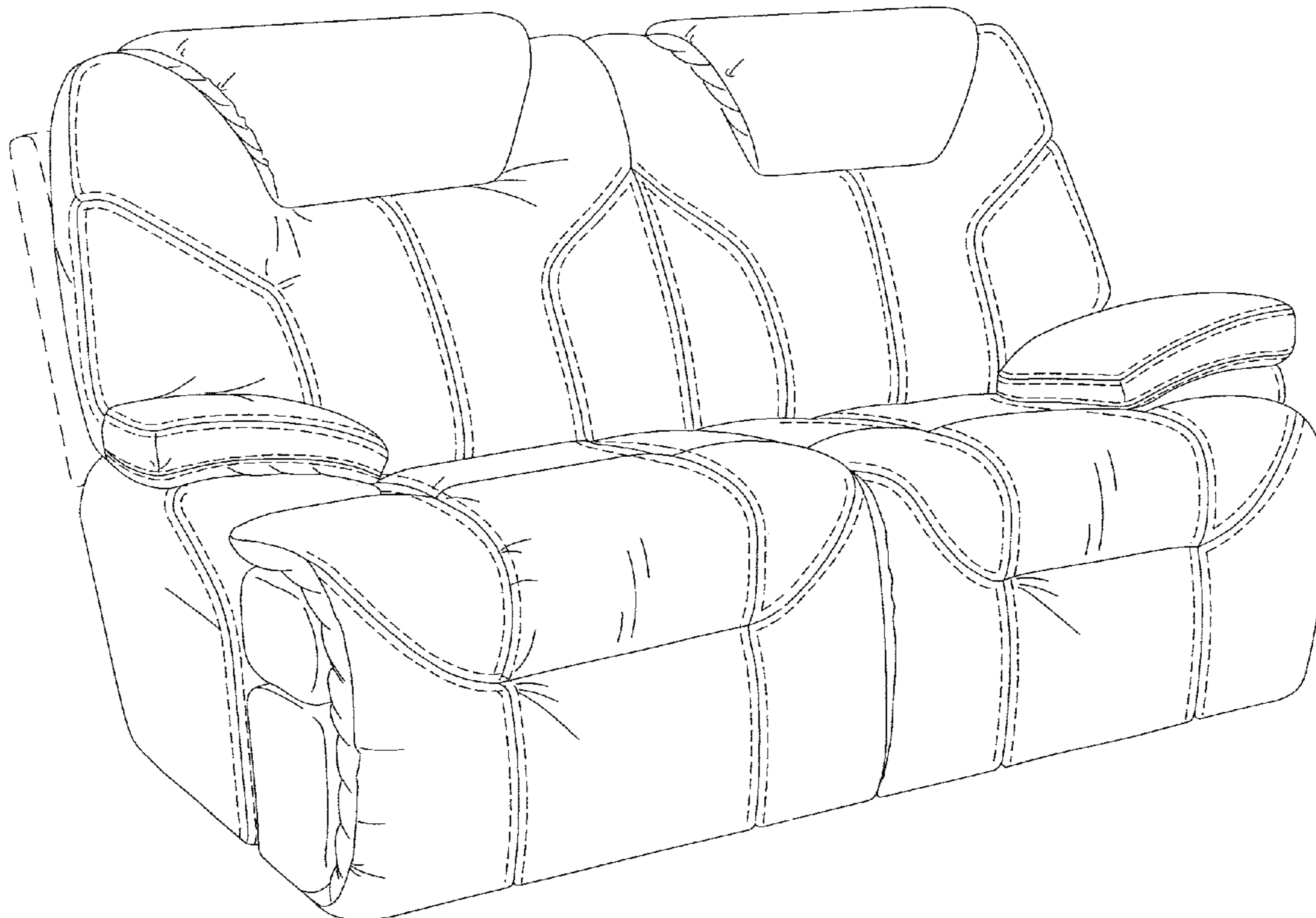

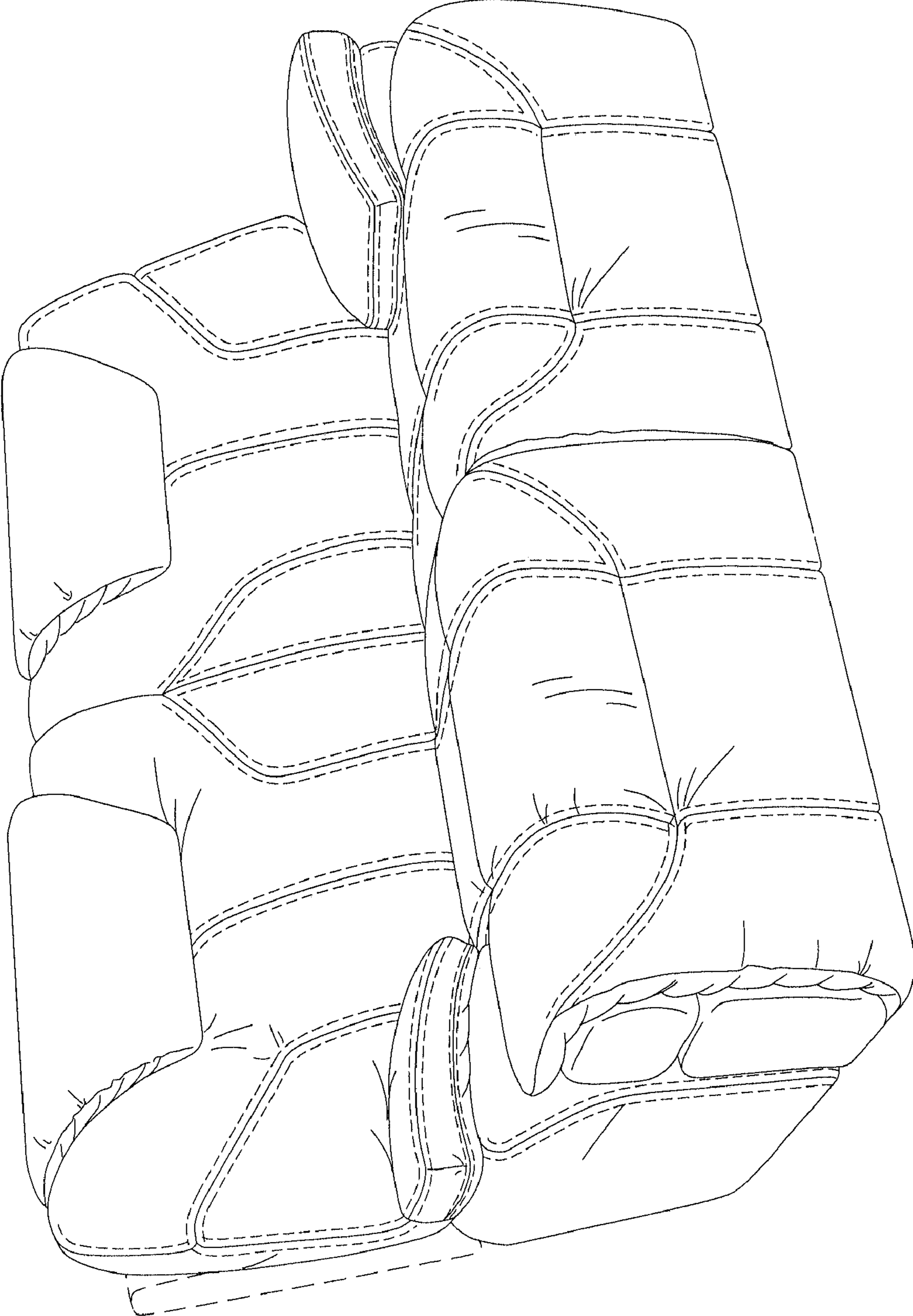

FIG. 1

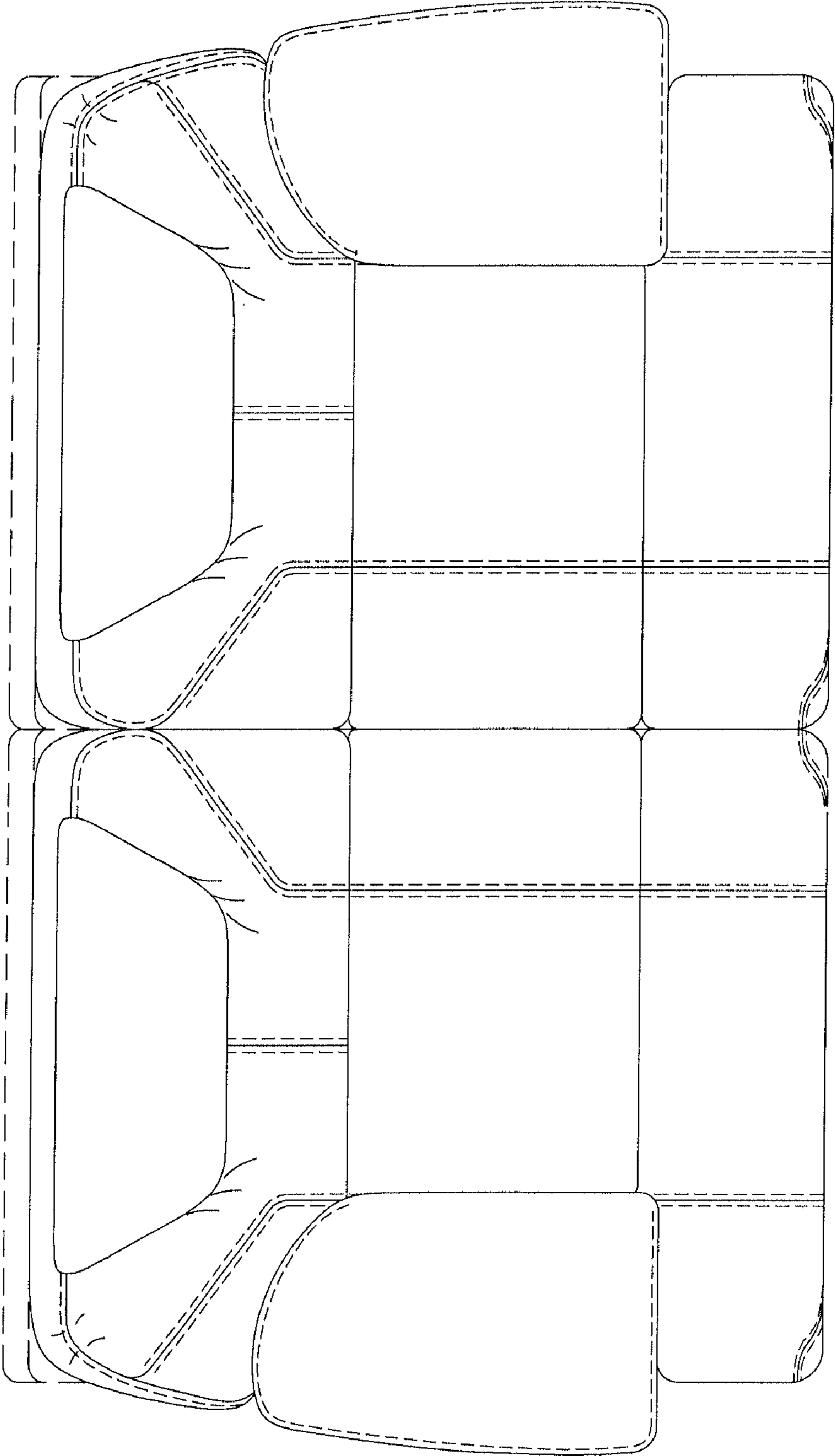

FIG. 2

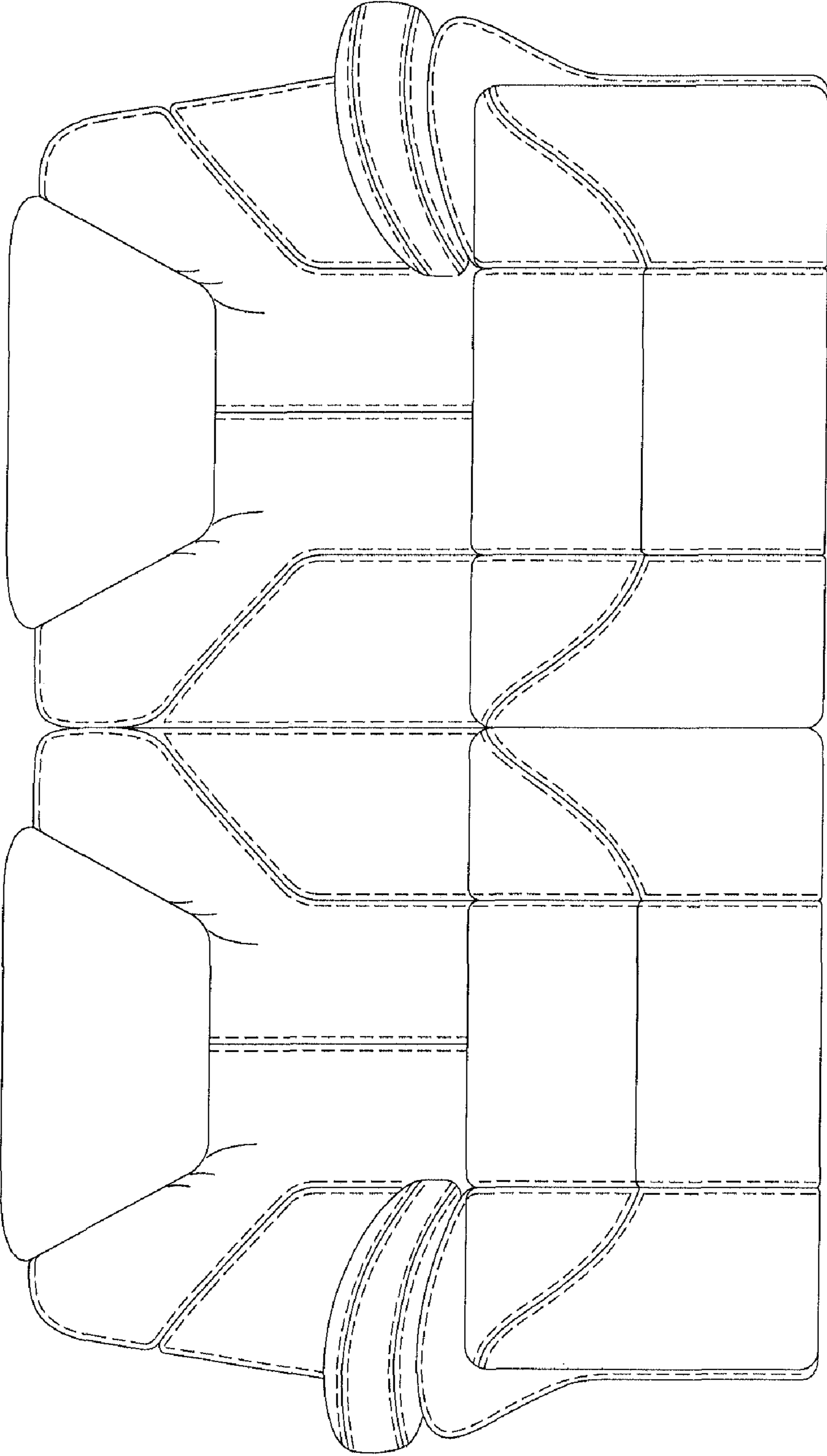

FIG. 3

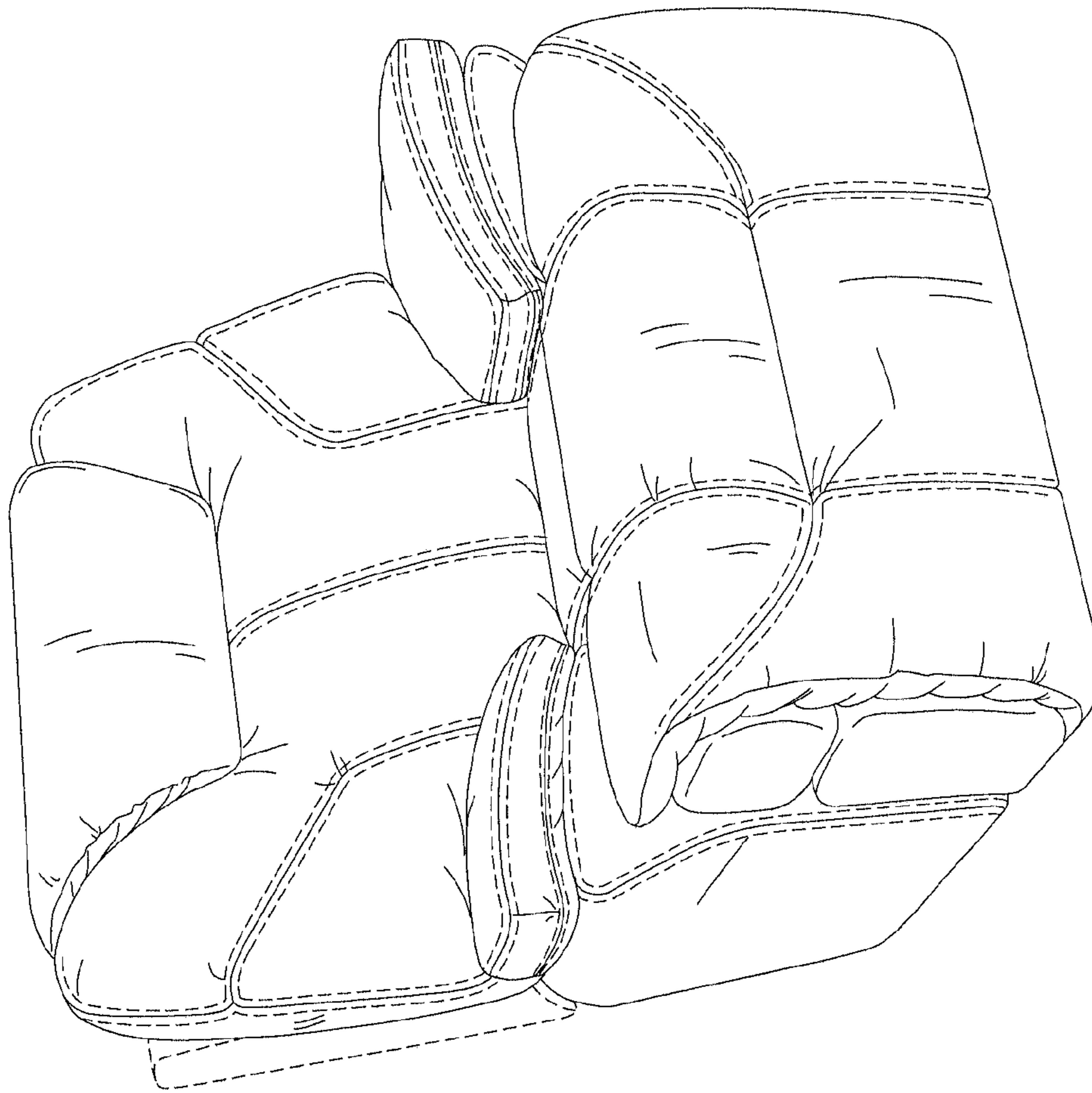

FIG. 4

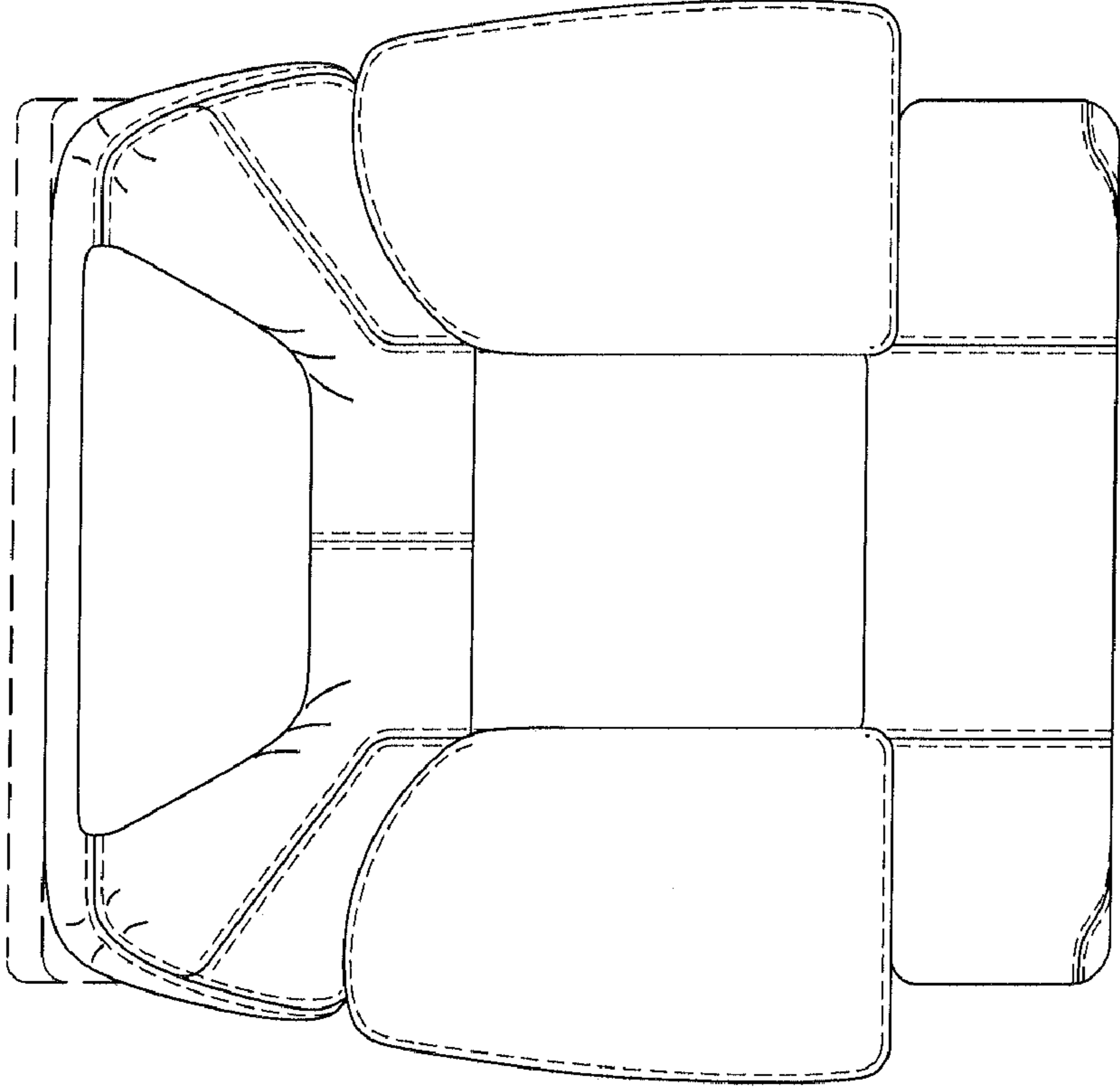

FIG. 5

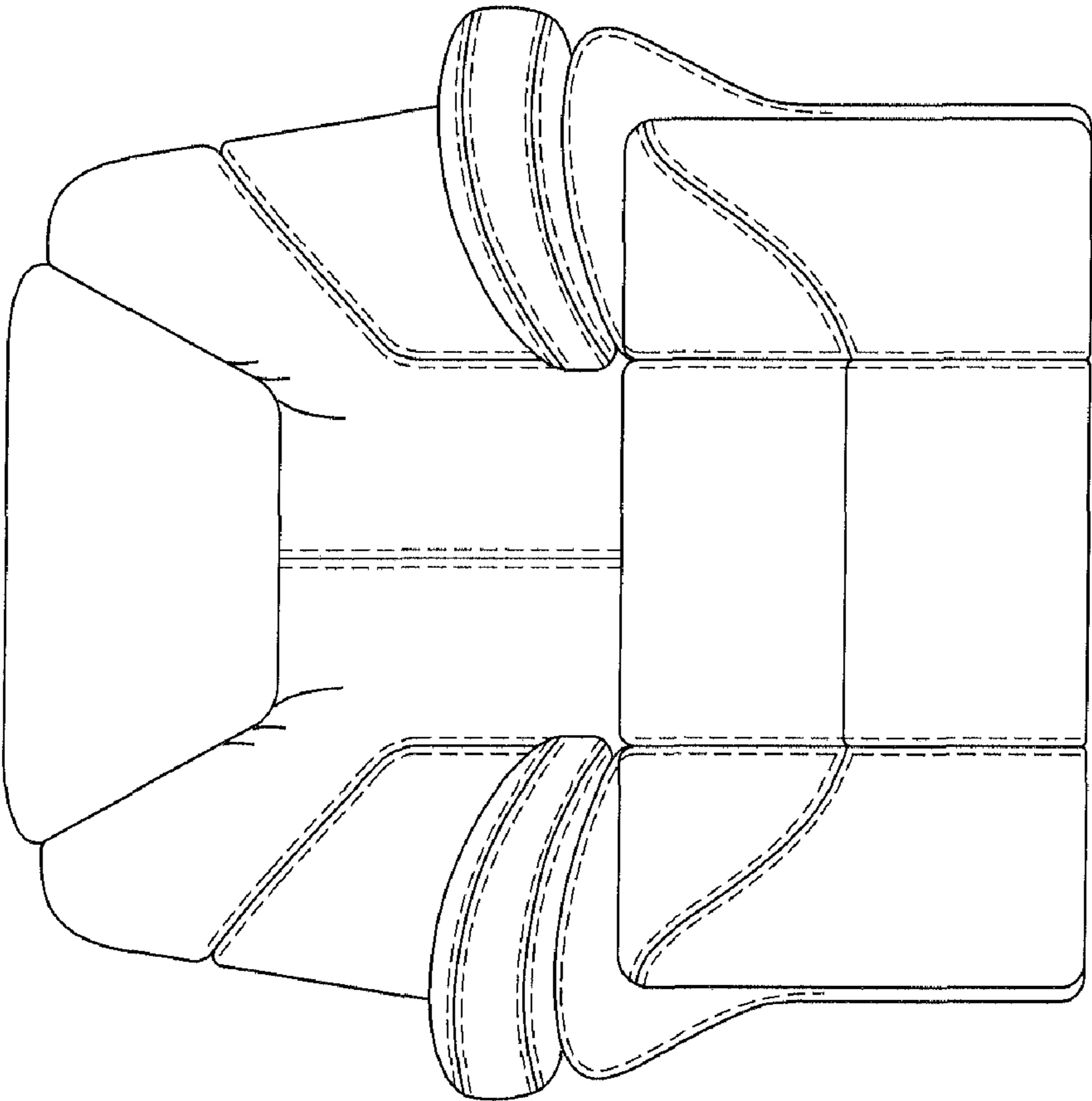

FIG. 6