



US00D613912S

(12) **United States Design Patent**
Benacquisto

(10) **Patent No.:** **US D613,912 S**

(45) **Date of Patent:** **** Apr. 13, 2010**

(54) **PET GROOMING TOOL**

(75) Inventor: **Justin Benacquisto**, Grand Rapids, MI (US)

(73) Assignee: **BISSELL Homecare, Inc.**, Grand Rapids, MI (US)

(**) Term: **14 Years**

(21) Appl. No.: **29/325,169**

(22) Filed: **Sep. 26, 2008**

(51) **LOC (9) Cl.** **30-99**

(52) **U.S. Cl.** **D30/158; D32/32**

(58) **Field of Classification Search** D30/158, D30/159, 199; 15/104.002, 230.11, 104.94, 15/104.8, 23, 231, 169, 184, 114, DIG. 14, 15/186-188; 132/119-119.1, 212; 206/15.2-15.3, 206/361, 362.3, 470; 242/571.4; D28/25, D28/23, 30, 59, 21; D4/117, 116, 121-123, D4/102, 199, 137, 131

See application file for complete search history.

(56) **References Cited**

U.S. PATENT DOCUMENTS

1,808,178 A	6/1931	Santini	
2,279,708 A *	4/1942	Jakob et al.	132/112
2,780,829 A *	2/1957	Cohen	15/365
3,421,171 A *	1/1969	Teruya	15/172
3,574,885 A	4/1971	Jones	
D222,792 S *	12/1971	Krusche et al.	D4/137
3,626,546 A *	12/1971	Dove	15/402
3,668,736 A *	6/1972	Loscalzo	15/402
D226,462 S *	3/1973	Gibbs	D4/114
3,835,869 A *	9/1974	Newman et al.	132/271
D293,629 S *	1/1988	Jordan	D4/115
4,779,572 A *	10/1988	Freulon	119/604
4,799,460 A *	1/1989	Kuhl	15/344
D304,883 S *	12/1989	Fan	D4/137
D307,067 S *	4/1990	Kuhl et al.	D30/158
D315,251 S *	3/1991	Clivio	D4/115
D317,083 S *	5/1991	Chou	D4/115
5,421,765 A *	6/1995	Lehmann et al.	446/296

D368,342 S *	3/1996	Founds	D32/18
D369,026 S *	4/1996	Furbert et al.	D4/115
5,502,873 A	4/1996	Hogan	
5,768,747 A	6/1998	Smith	
5,924,202 A *	7/1999	Romani	30/133
D417,551 S *	12/1999	Pinchuk	D4/136
6,022,163 A *	2/2000	Asfur	401/175
6,055,938 A	5/2000	Klein	
D444,925 S *	7/2001	Monette	D30/158
D453,420 S *	2/2002	Offer et al.	D4/132
6,367,421 B1 *	4/2002	Deacon	119/603
D460,272 S *	7/2002	Fong	D4/138
D465,309 S *	11/2002	Foersterling	D32/35
D473,987 S *	4/2003	Foersterling	D32/35
D476,160 S *	6/2003	Choi	D4/121
D504,234 S *	4/2005	Kuo et al.	D4/133
D506,585 S *	6/2005	Muller et al.	D32/32
6,986,217 B2 *	1/2006	Leung et al.	38/77.83

(Continued)

Primary Examiner—Susan Moon Lee

(74) *Attorney, Agent, or Firm*—McGarry Bair PC

(57)

CLAIM

The ornamental design for a pet grooming tool, as shown and described.

DESCRIPTION

FIG. 1 is a top left side perspective view of a pet grooming tool which embodies our design;

FIG. 2 is a bottom right side perspective view thereof;

FIG. 3 is a top view thereof;

FIG. 4 is a bottom view thereof; and

FIG. 5 is a left side view thereof, the right side view thereof is a mirror image thereof,

FIG. 6 is a front view thereof; and,

FIG. 7 is a rear view thereof.

The portions shown in broken line are not claimed.

1 Claim, 2 Drawing Sheets

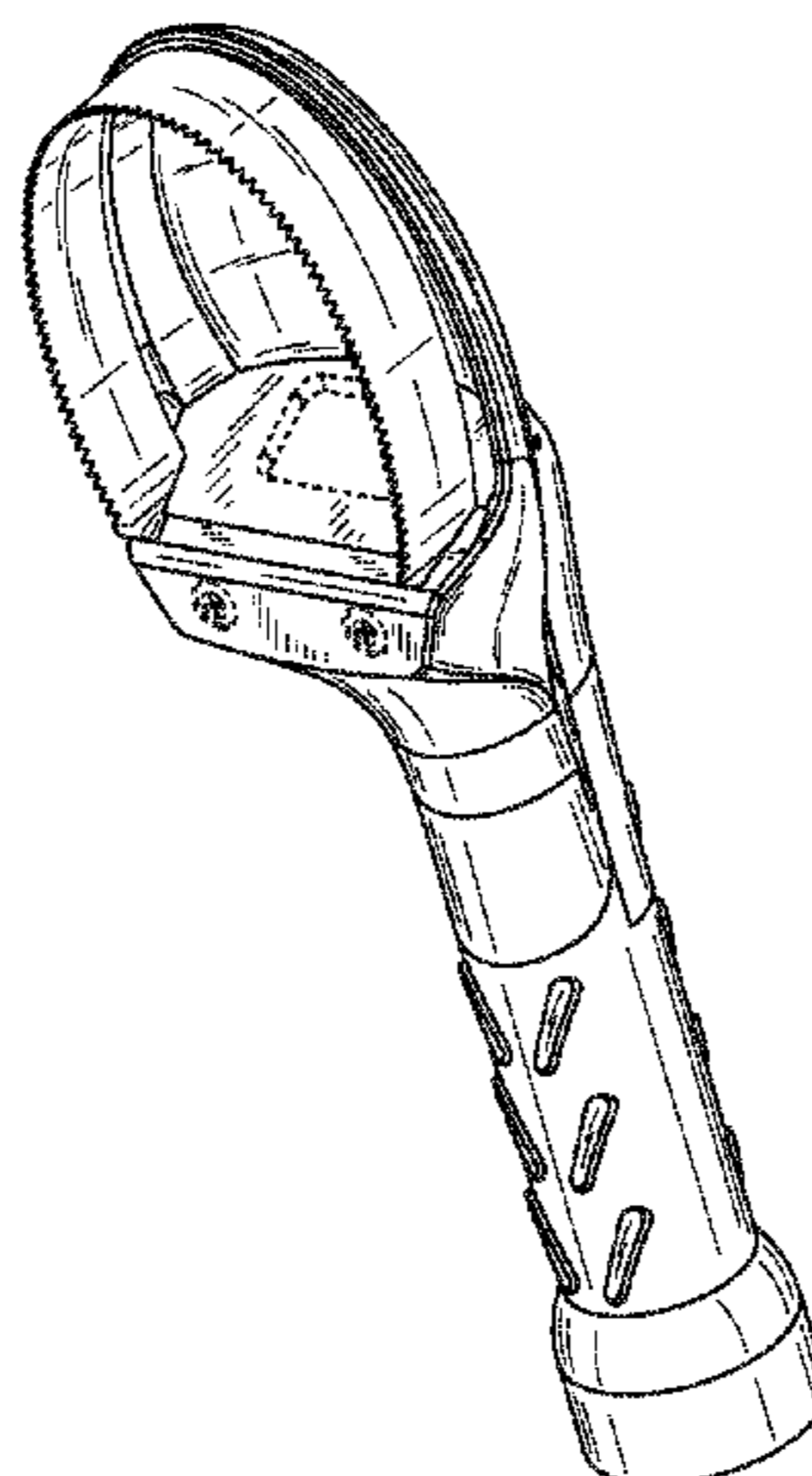

US D613,912 S

Page 2

U.S. PATENT DOCUMENTS

D515,819 S *	2/2006	Gaiti	D4/115	D590,157 S *	4/2009	Martin	D4/136
7,100,537 B1 *	9/2006	Suen et al.	119/612	D595,964 S *	7/2009	Choi	D4/114
7,155,117 B2 *	12/2006	Leung et al.	392/404	D596,362 S *	7/2009	Crevling et al.	D32/33
D538,047 S *	3/2007	Draughn	D4/138	D601,806 S *	10/2009	Choi	D4/114
D547,068 S *	7/2007	Major	D4/136	D601,807 S *	10/2009	Choi	D4/114
D590,111 S *	4/2009	Wiljanen et al.	D32/32	2002/0096125 A1 *	7/2002	Fong	119/664
				2004/0105715 A1 *	6/2004	Spelman et al.	401/6

* cited by examiner

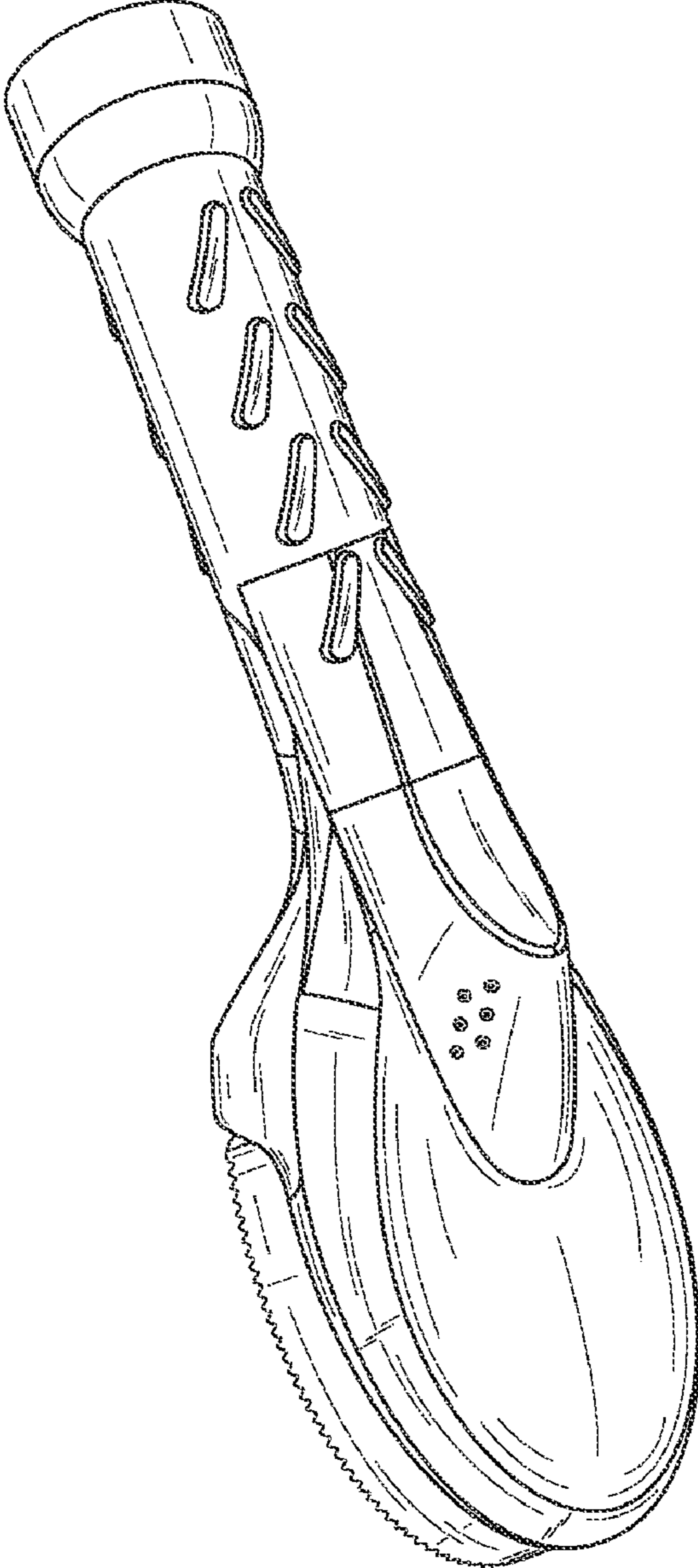

Fig. 1

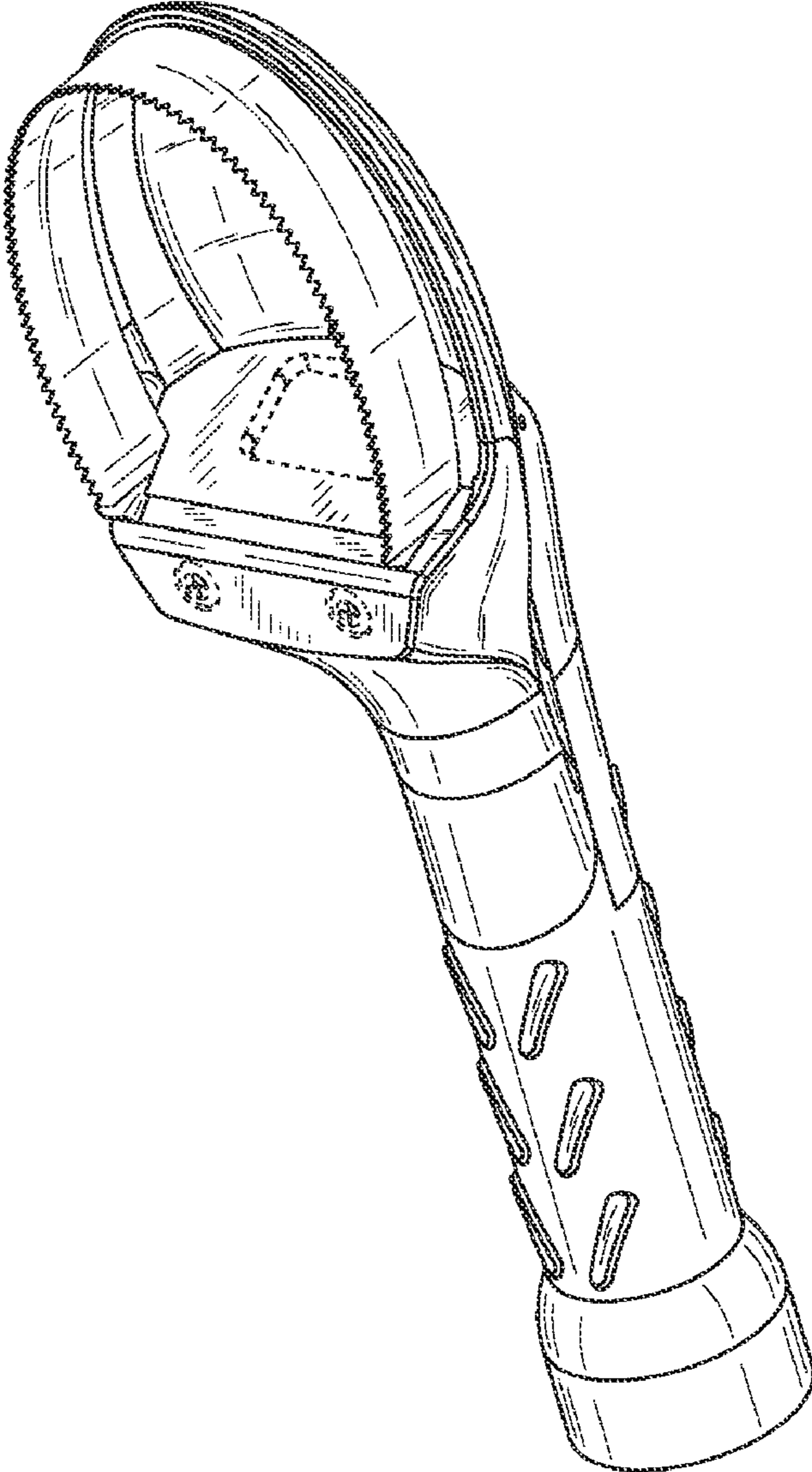

Fig. 2

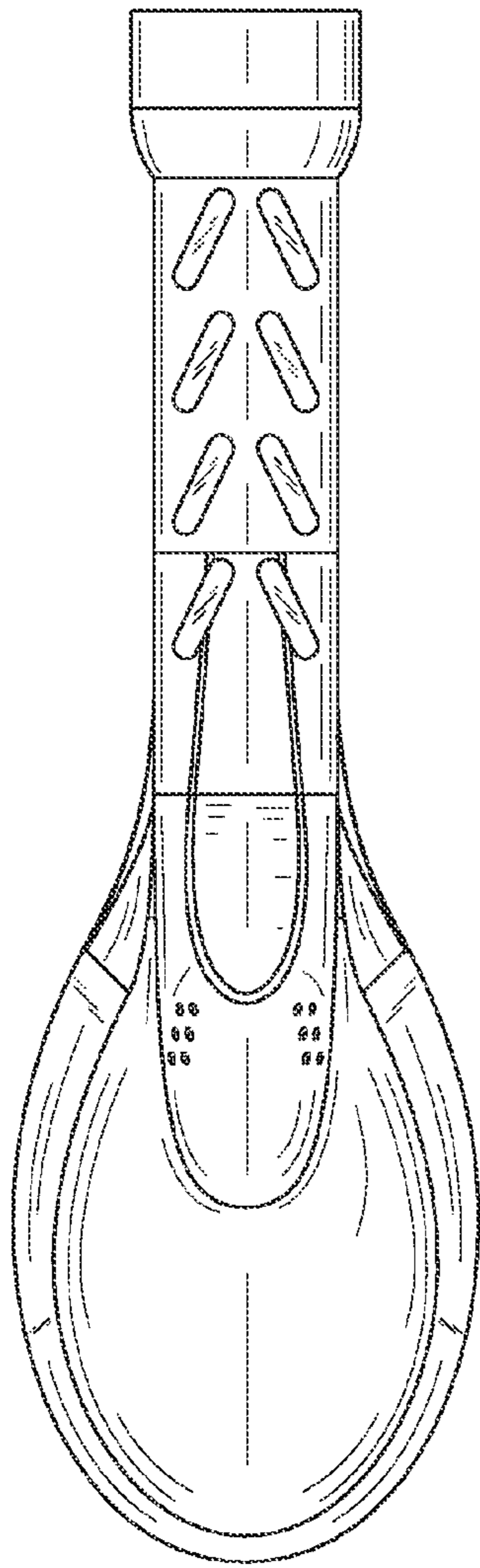

Fig. 3

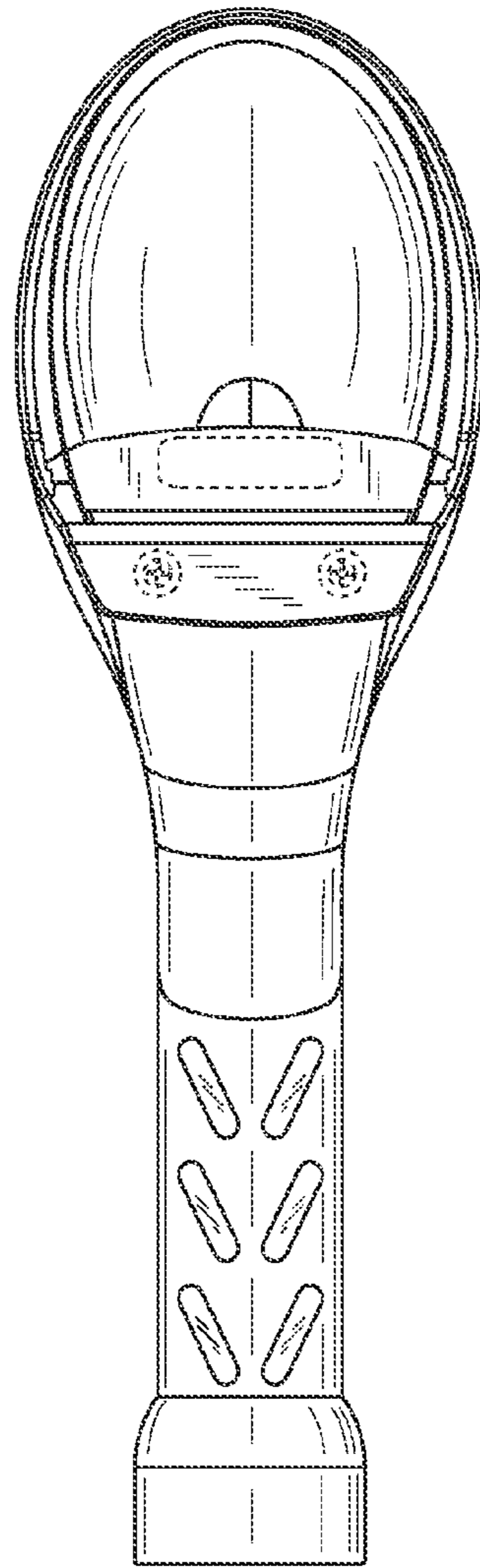

Fig. 4

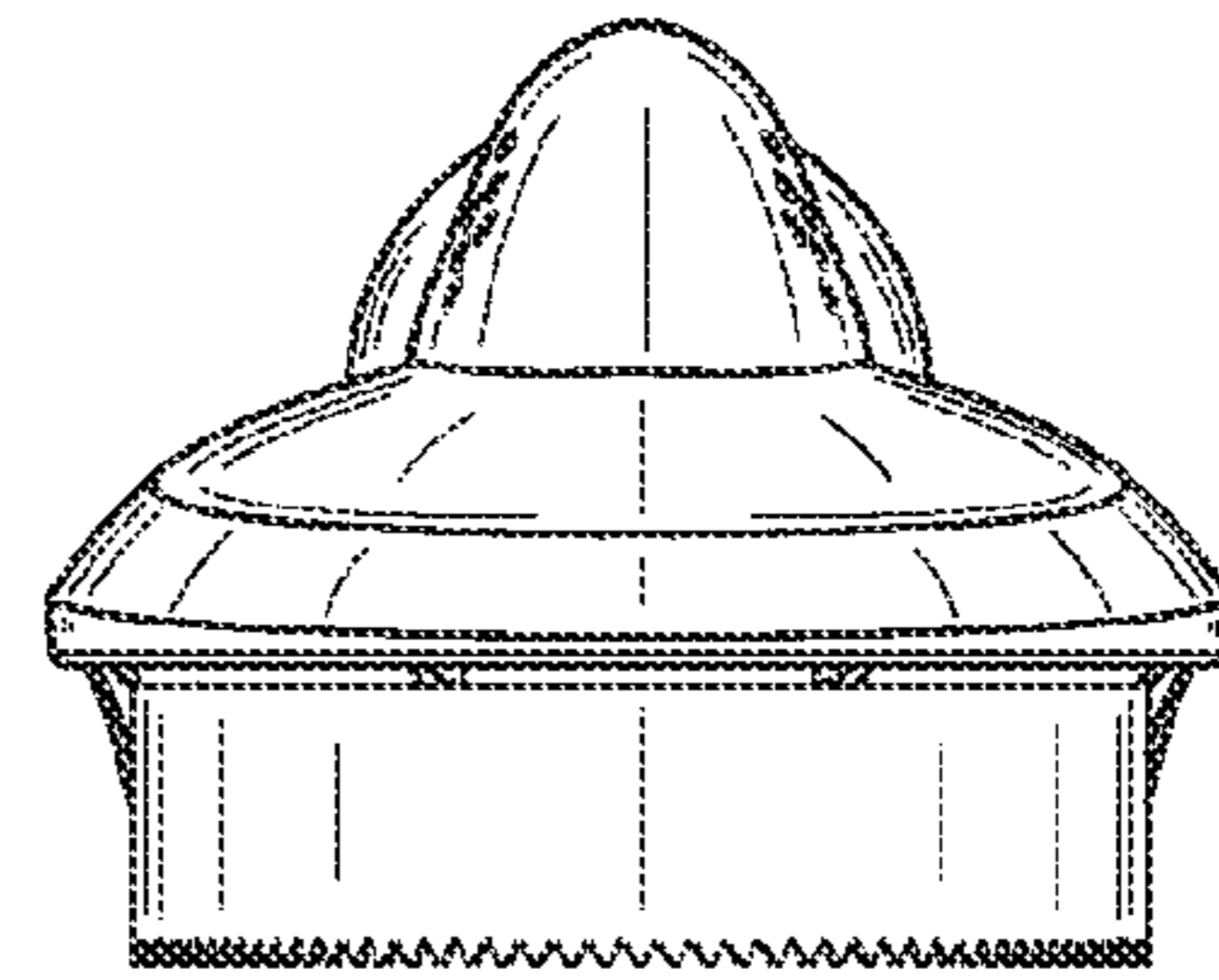

Fig. 6

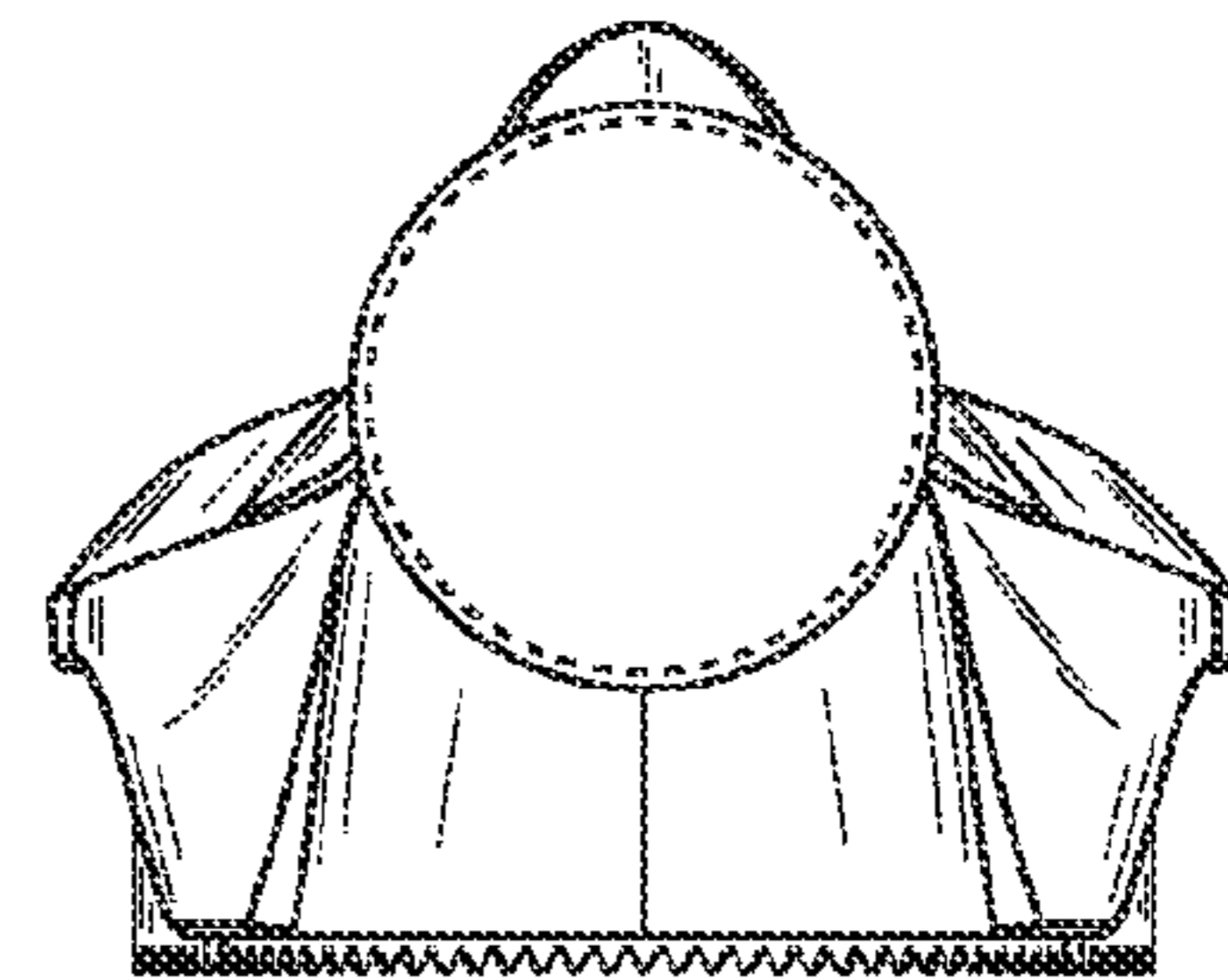

Fig. 7

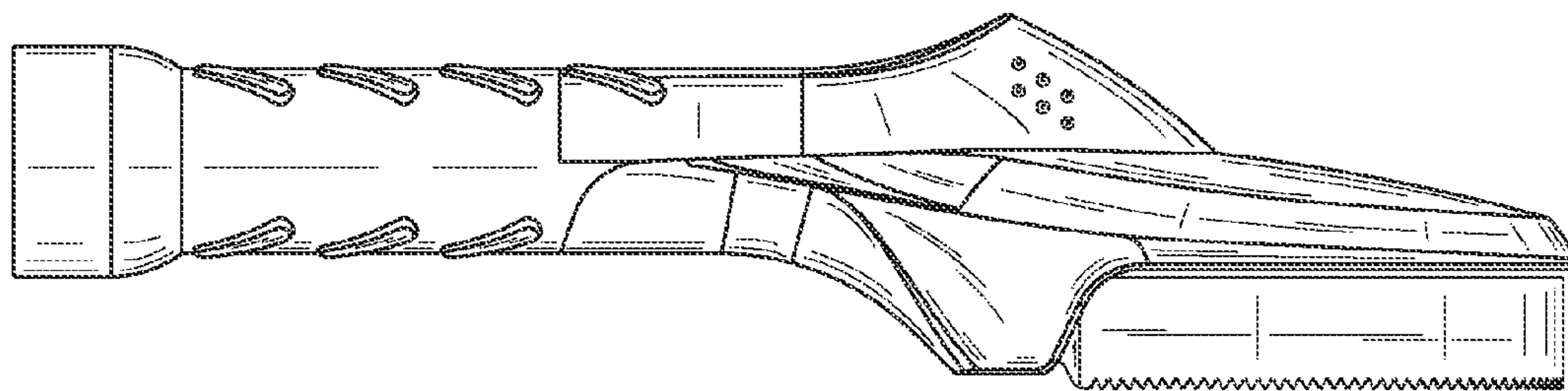

Fig. 5