



US00D613889S

(12) **United States Design Patent**
Liu

(10) **Patent No.:** **US D613,889 S**
(45) **Date of Patent:** **** Apr. 13, 2010**

- (54) **LIGHT EMITTING DIODE BULB**
- (75) Inventor: **Yu-Pin Liu, Miao-Li Hsien (TW)**
- (73) Assignee: **Foxsemicon Integrated Technology, Inc., Chu-Nan, Miao-Li Hsien (TW)**
- (**) Term: **14 Years**
- (21) Appl. No.: **29/346,256**
- (22) Filed: **Oct. 29, 2009**
- (30) **Foreign Application Priority Data**
Aug. 7, 2009 (CN) 2009 3 0311340.6
- (51) **LOC (9) Cl.** **26-06**
- (52) **U.S. Cl.** **D26/4**
- (58) **Field of Classification Search** D26/1-4;
313/313, 315, 316, 317, 318, 493; 315/52,
315/53, 56, 57, 58
See application file for complete search history.

D99,637 S *	5/1936	Abramson	D26/4
D370,282 S *	5/1996	Grether	D26/4
D381,441 S *	7/1997	Cheung	D26/4

* cited by examiner

Primary Examiner—Marcus A Jackson
(74) *Attorney, Agent, or Firm*—Raymond J. Chew

(57) **CLAIM**

The ornamental design for a light emitting diode bulb, as shown.

DESCRIPTION

FIG. 1 is a perspective view of a light emitting diode bulb showing our new design.

FIG. 2 is a front elevational view thereof.

FIG. 3 is a rear elevational view thereof.

FIG. 4 is a left-side, elevational view thereof.

FIG. 5 is a right-side, elevational view thereof.

FIG. 6 is a top plan view thereof; and,

FIG. 7 is a bottom plan view thereof.

1 Claim, 7 Drawing Sheets

- (56) **References Cited**
U.S. PATENT DOCUMENTS
D94,890 S * 3/1935 Graf D26/4

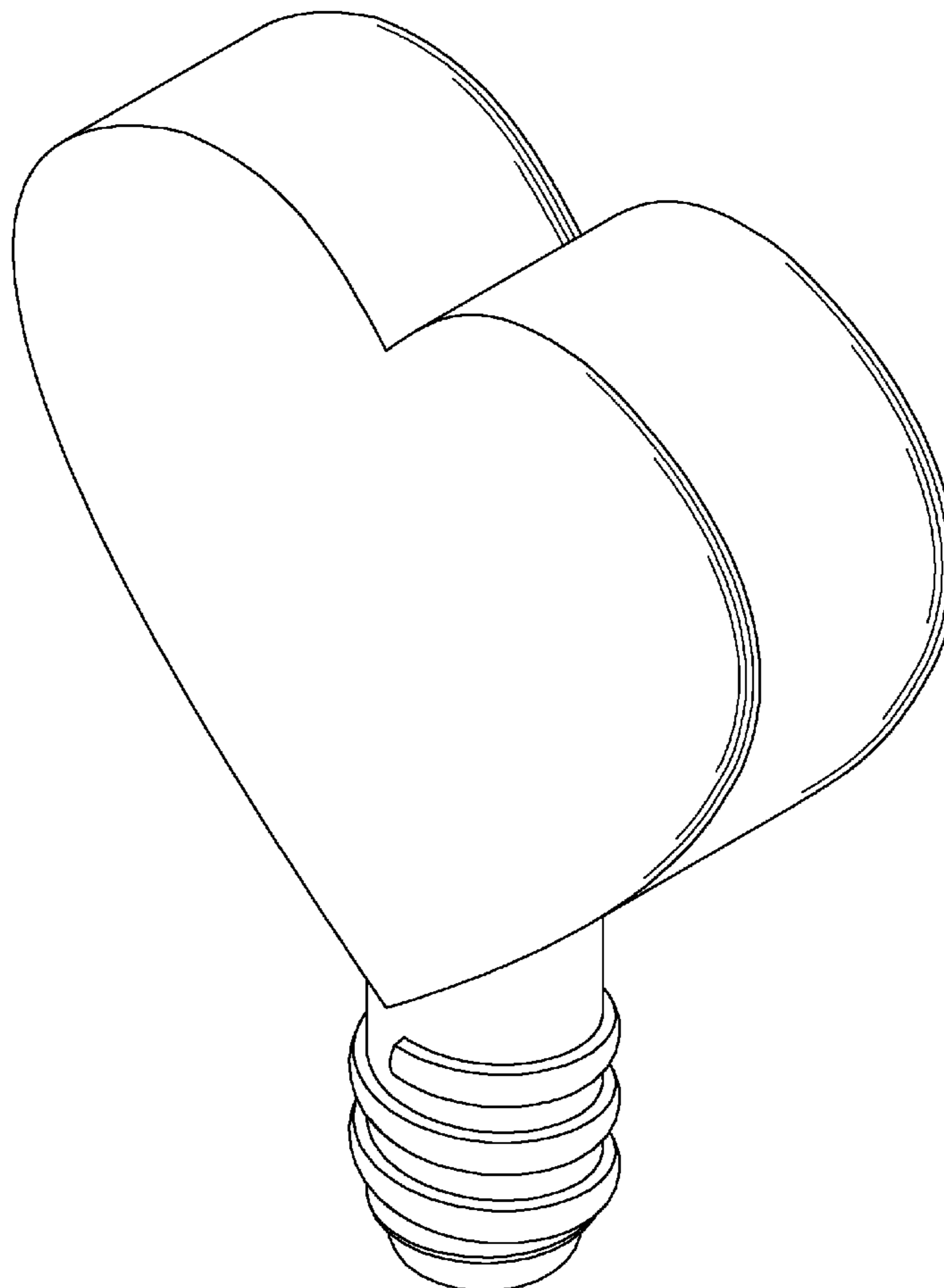

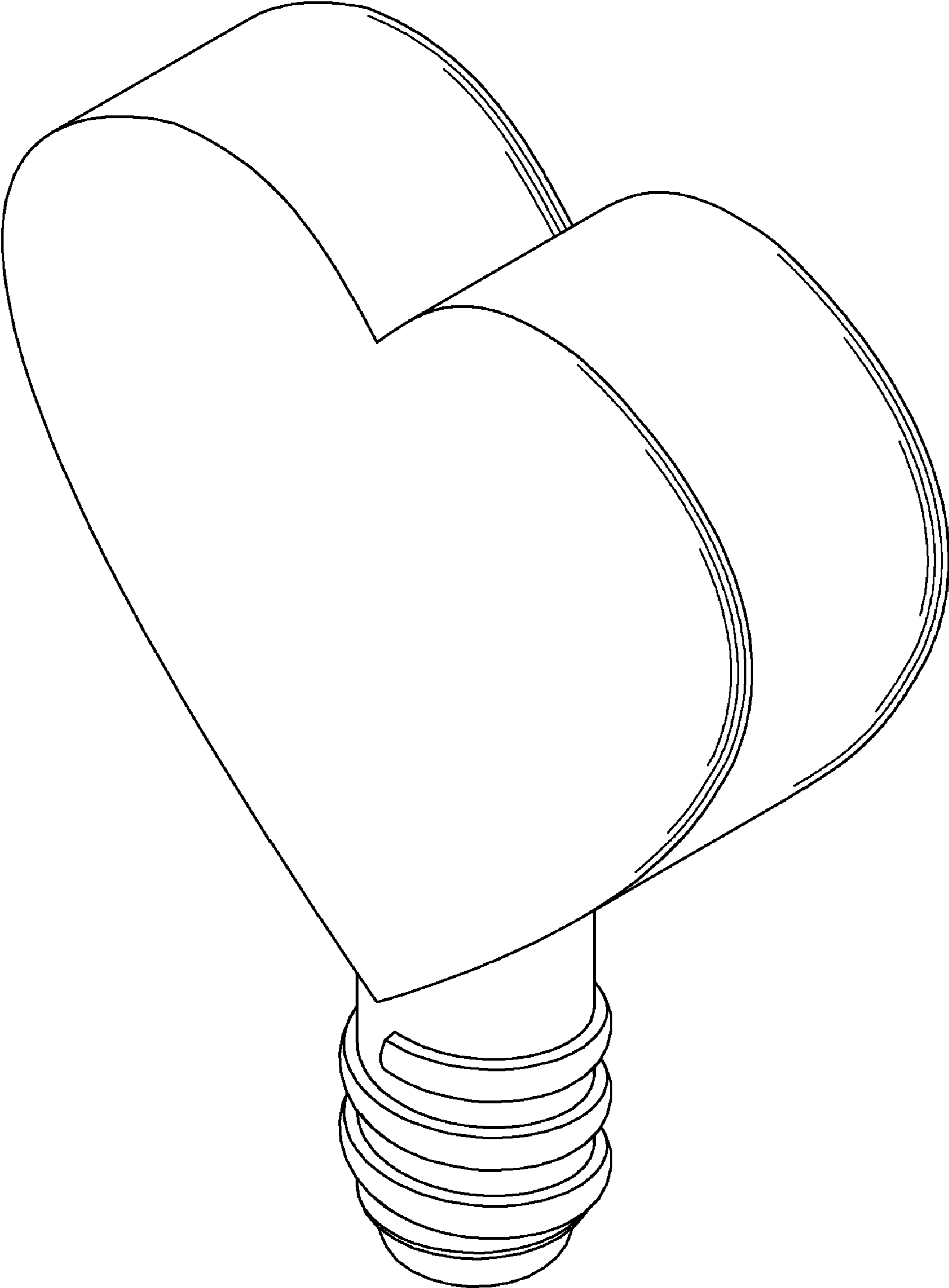

FIG. 1

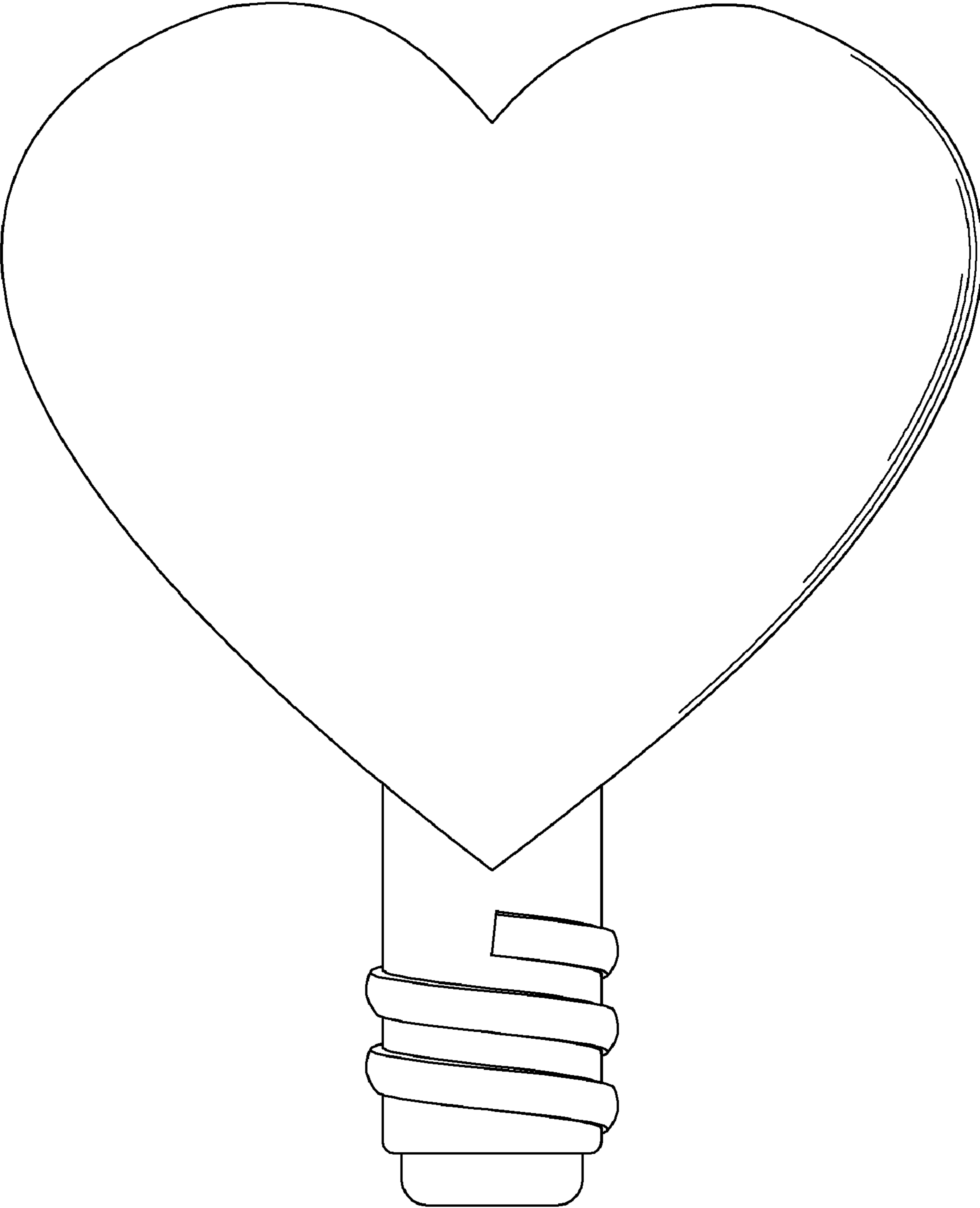

FIG. 2

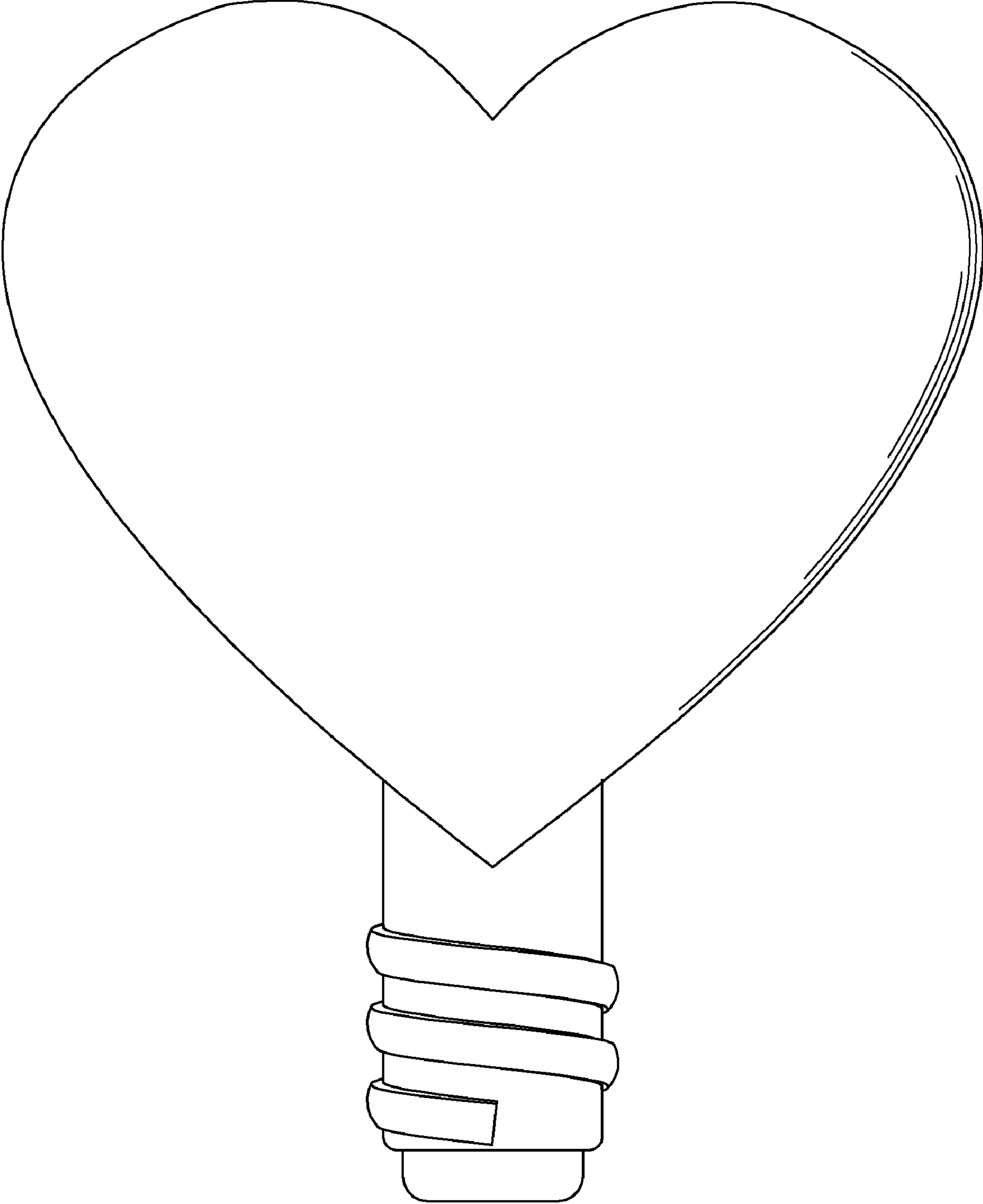

FIG. 3

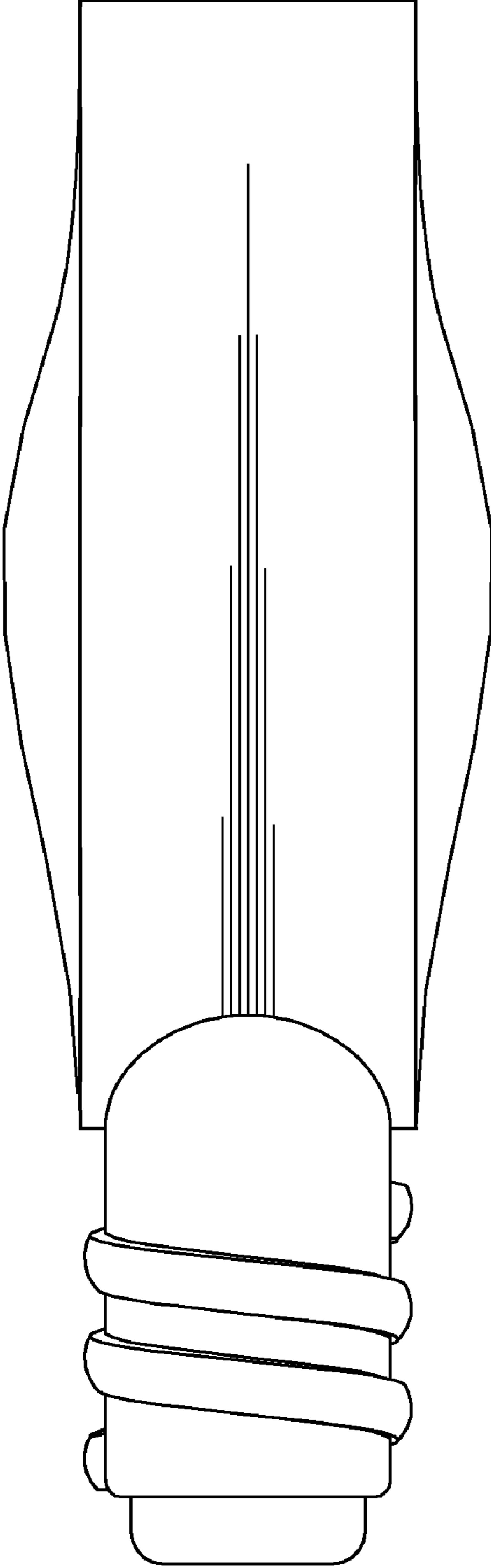

FIG. 4

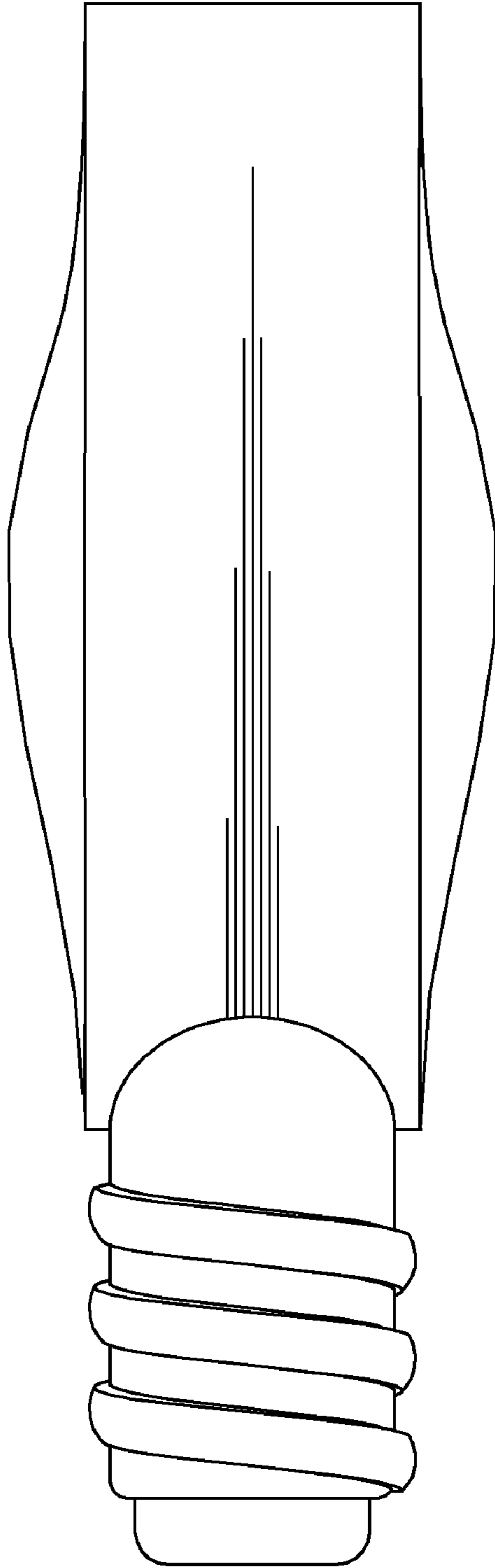

FIG. 5

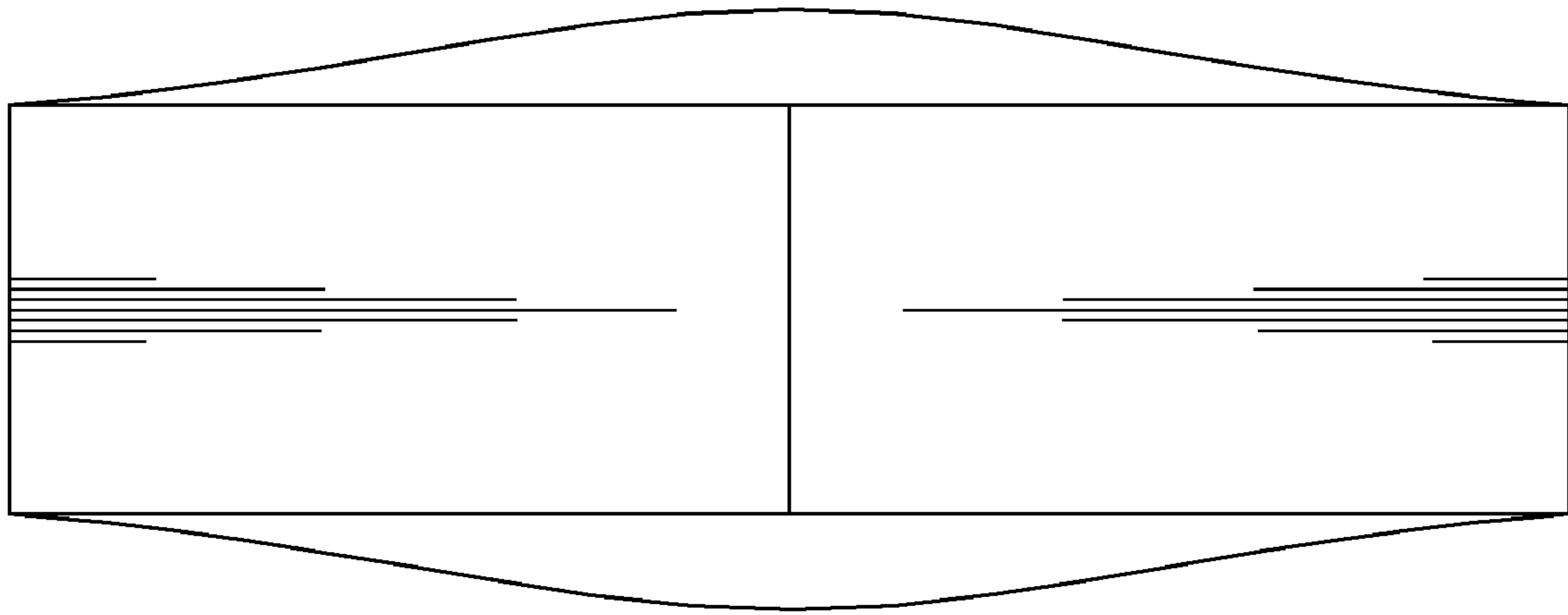

FIG. 6

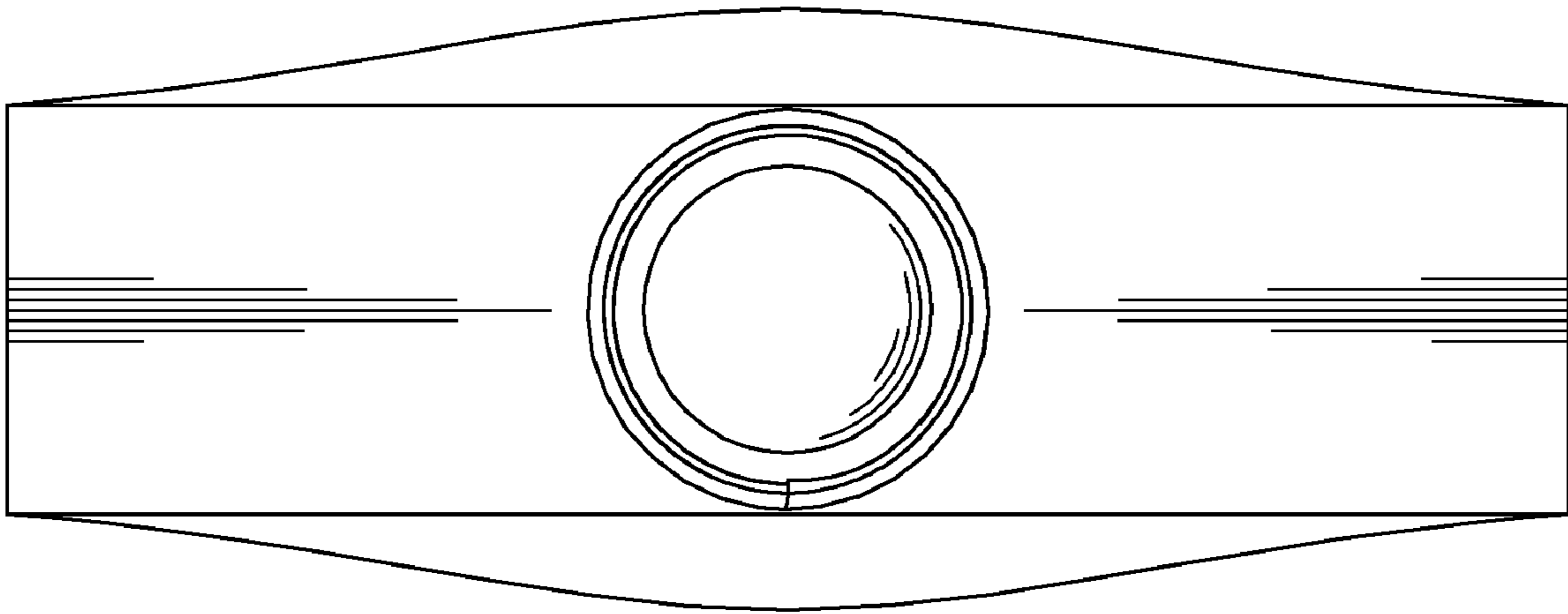

FIG. 7