



US00D613844S

(12) **United States Design Patent**  
**Jørgensen**

(10) **Patent No.:** **US D613,844 S**  
(45) **Date of Patent:** **\*\* Apr. 13, 2010**

(54) **AROMATIC NEBULIZING DIFFUSER**

(57) **CLAIM**

(75) Inventor: **Carsten Jørgensen**, Kastanienbaum (CH)

The ornamental design for an aromatic nebulizing diffuser, as shown and described.

(73) Assignee: **Ming Jen Hsiao**, Miaoli County (TW)

**DESCRIPTION**

(\*\*) Term: **14 Years**

FIG. 1 is a perspective view of a partially transparent aromatic nebulizing diffuser embodying the design;

(21) Appl. No.: **29/340,233**

FIG. 2 is a front view of a partially transparent aromatic nebulizing diffuser embodying the design shown in FIG. 1;

(22) Filed: **Jul. 15, 2009**

FIG. 3 is a rear view of a partially transparent aromatic nebulizing diffuser embodying the design shown in FIG. 1;

(51) **LOC (9) Cl.** ..... **28-99**

FIG. 4 is a left side view of a partially transparent aromatic nebulizing diffuser embodying the design shown in FIG. 1;

(52) **U.S. Cl.** ..... **D23/366**

FIG. 5 is a right side view of a partially transparent aromatic nebulizing diffuser embodying the design shown in FIG. 1;

(58) **Field of Classification Search** ..... D23/355-369;  
D28/5, 6; 261/DIG. 17, DIG. 42, DIG. 65,  
261/DIG. 88, DIG. 89; 392/386, 390, 391,  
392/392, 394, 395; 239/34, 35, 43-45, 53,  
239/56, 57, 60, 326

FIG. 6 is a top plan of a partially transparent aromatic nebulizing diffuser embodying the design shown in FIG. 1; and

See application file for complete search history.

FIG. 7 is a bottom view of a partially transparent aromatic nebulizing diffuser embodying the design shown in FIG. 1;

(56) **References Cited**

FIG. 8 is a perspective view of a second embodiment of an aromatic nebulizing diffuser embodying the design;

**U.S. PATENT DOCUMENTS**

D229,754 S *	1/1974	Ali	.....	D23/367
D240,829 S *	8/1976	Jones	.....	D9/689
D330,757 S *	11/1992	DeLaney et al.	.....	D23/364
5,851,442 A *	12/1998	Spector	.....	261/30
D450,110 S *	11/2001	Montagnino et al.	.....	D23/356
D522,641 S *	6/2006	Matsuda et al.	.....	D23/366
D522,642 S *	6/2006	Matsuda et al.	.....	D23/366
D531,294 S *	10/2006	Kazakevicius et al.	.....	D23/366
D588,252 S *	3/2009	Conway et al.	.....	D23/366
D592,295 S *	5/2009	Nanda	.....	D23/356

FIG. 9 is a front view of an aromatic nebulizing diffuser embodying the design shown in FIG. 8;

FIG. 10 is a rear view of an aromatic nebulizing diffuser embodying the design shown in FIG. 8;

FIG. 11 is a left side view of an aromatic nebulizing diffuser embodying the design shown in FIG. 8;

FIG. 12 is a right side view of an aromatic nebulizing diffuser embodying the design shown in FIG. 8;

FIG. 13 is a top plan of an aromatic nebulizing diffuser embodying the design shown in FIG. 8; and,

FIG. 14 is a bottom view of an aromatic nebulizing diffuser embodying the design shown in FIG. 8.

\* cited by examiner

The broken lines shown in the drawings are for illustrative purposes only and form no part of the claimed design.

*Primary Examiner*—Sandra Snapp

**1 Claim, 14 Drawing Sheets**

(74) *Attorney, Agent, or Firm*—Ming Chow; Sinorica, LLC

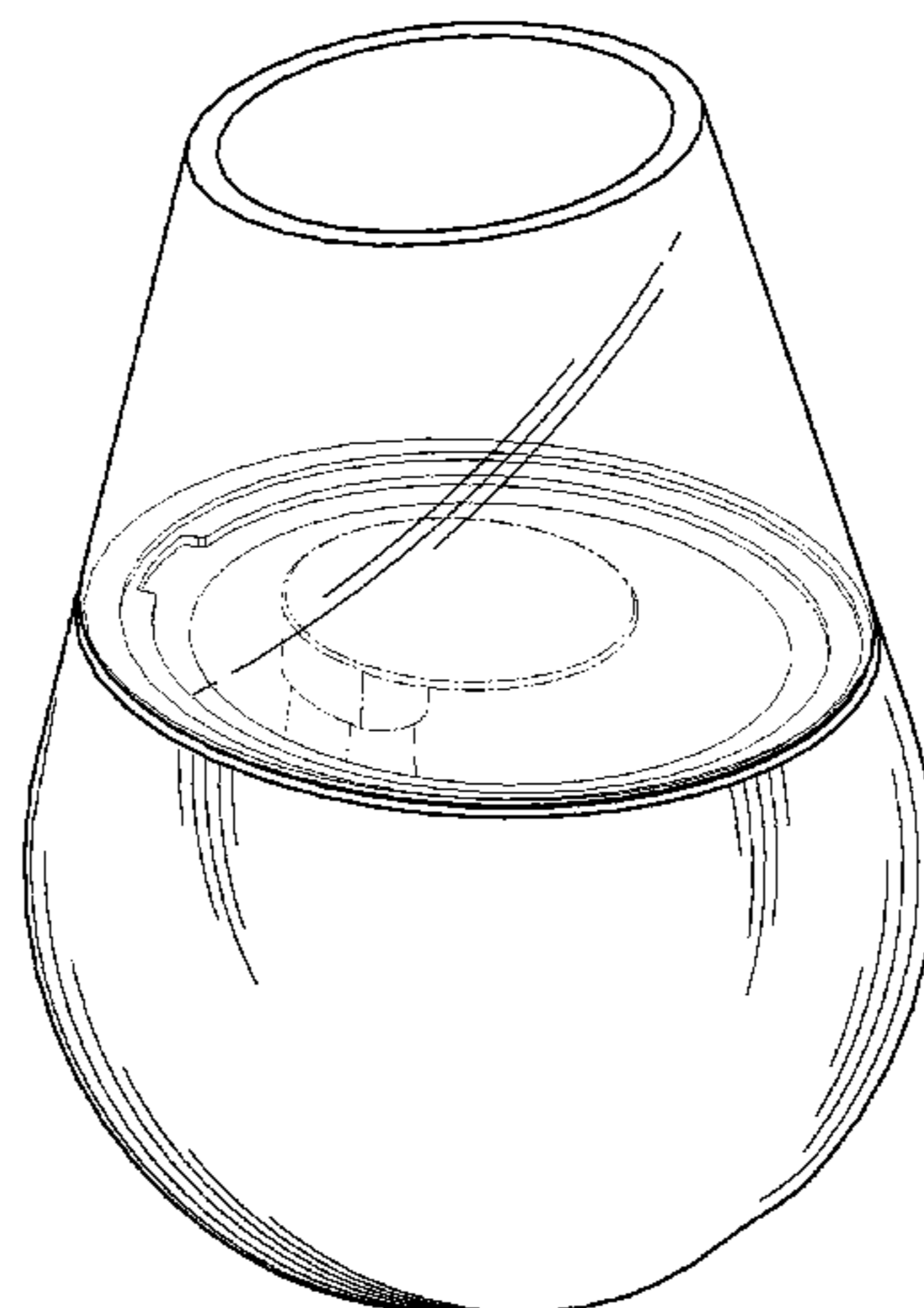

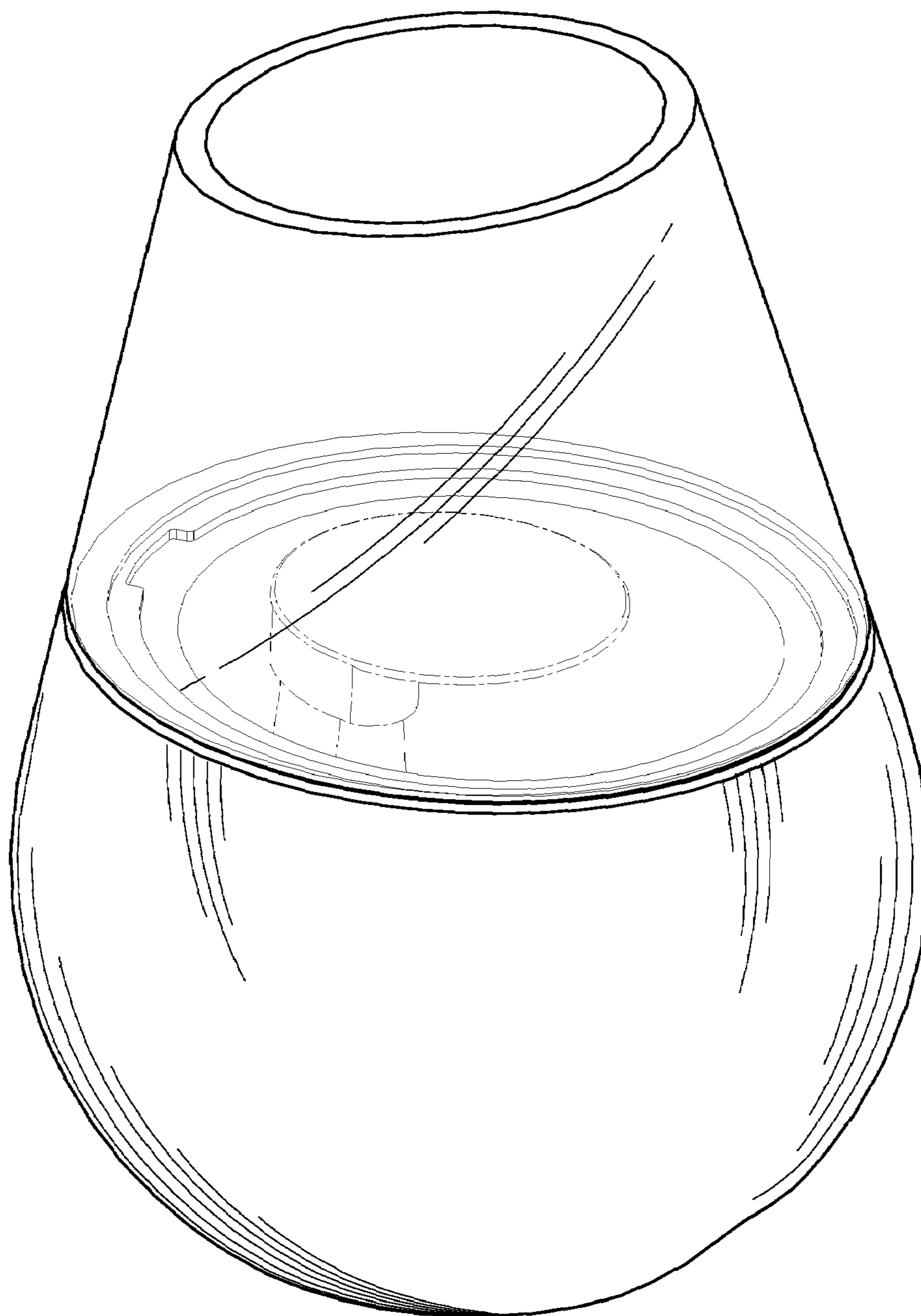

FIG. 1

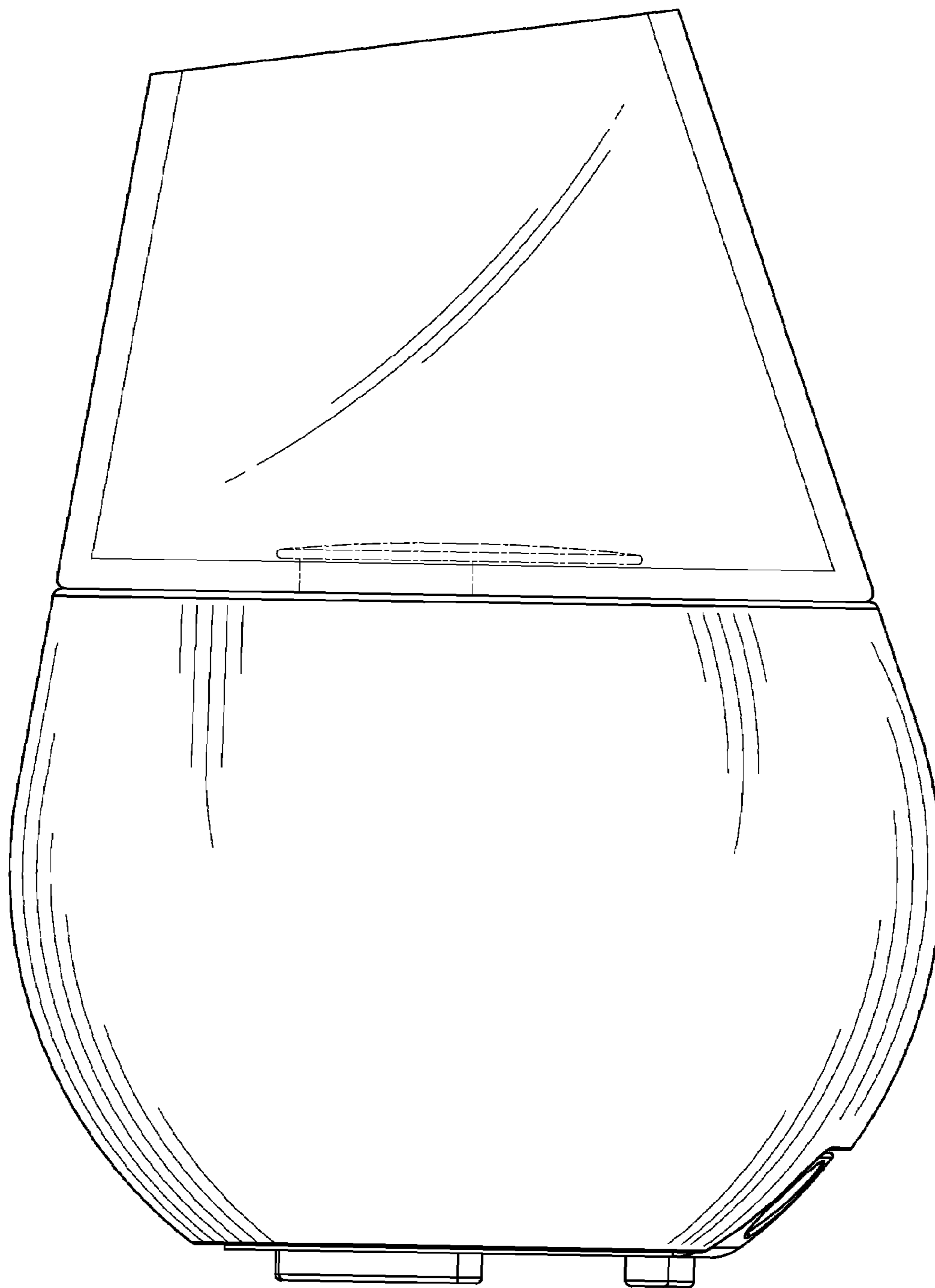

FIG. 2

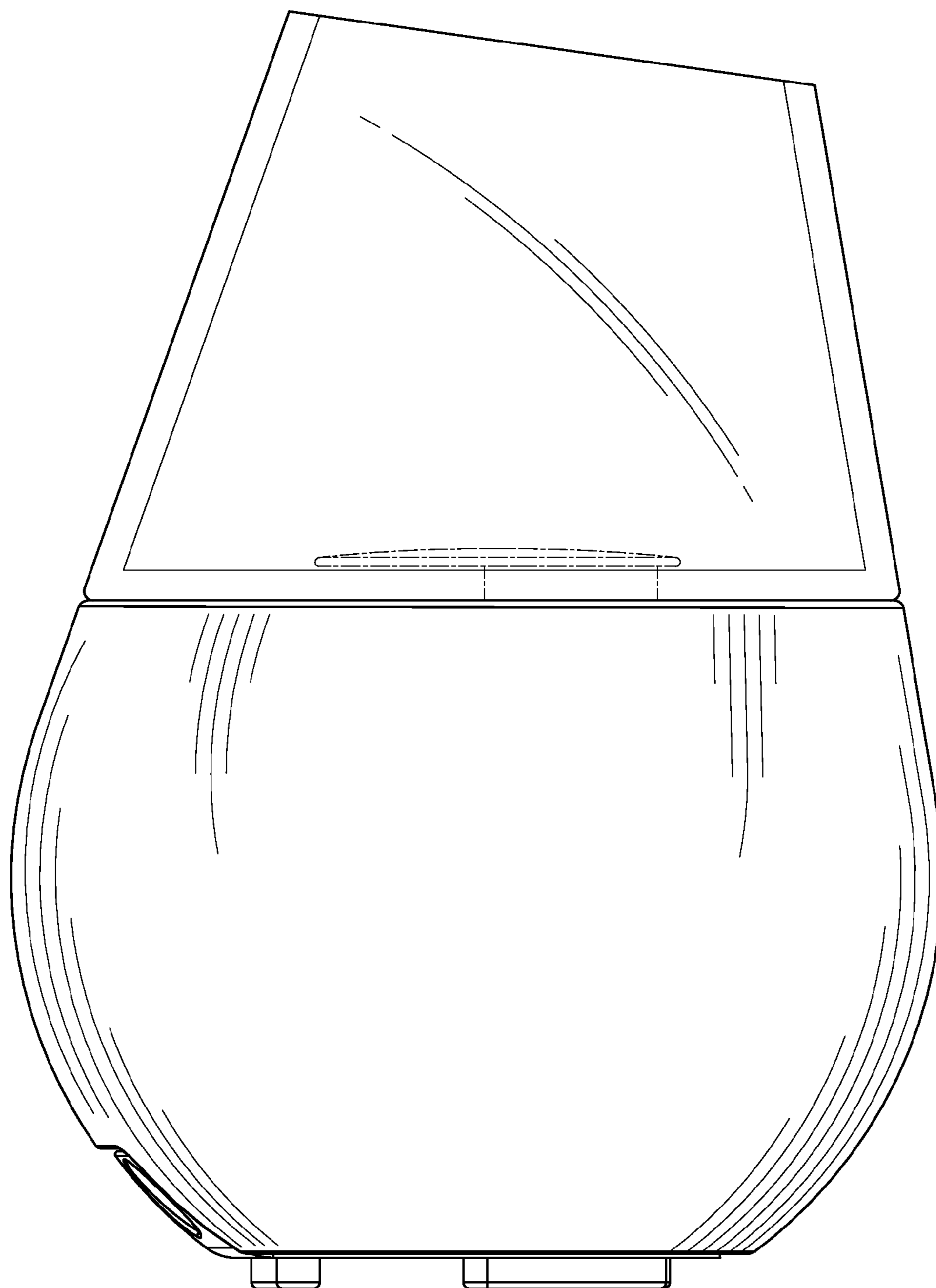

FIG. 3

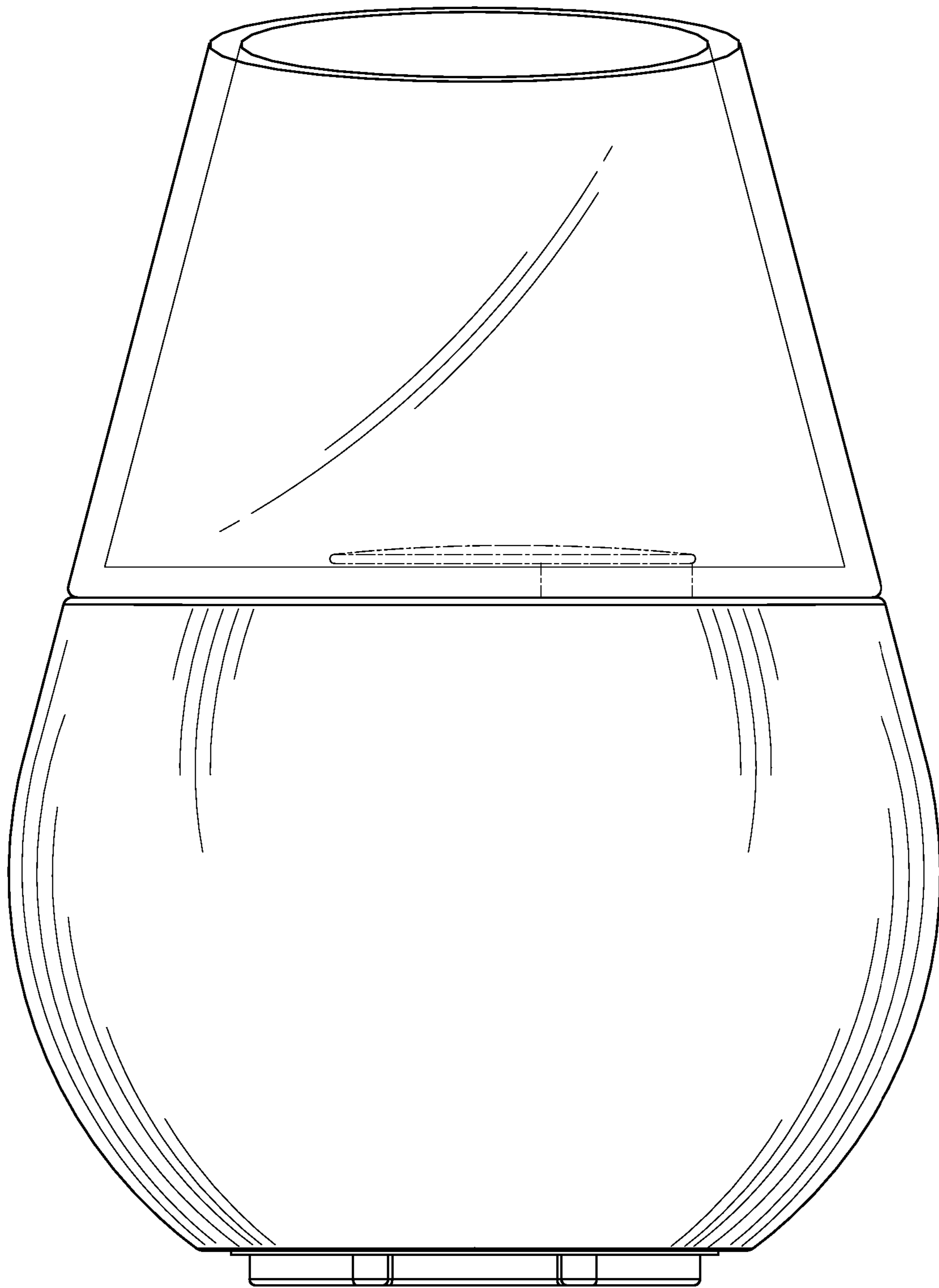

FIG. 4

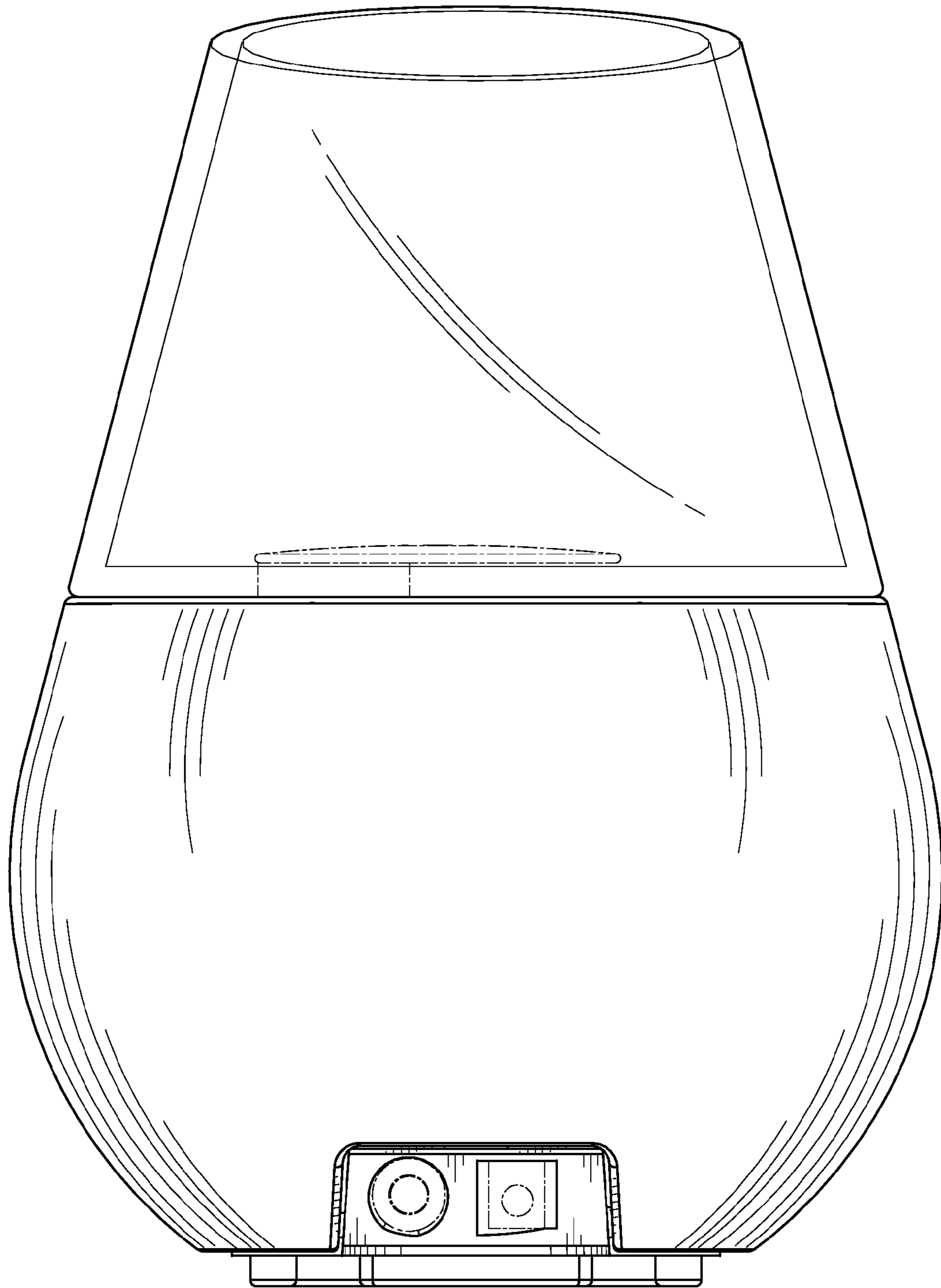

FIG. 5

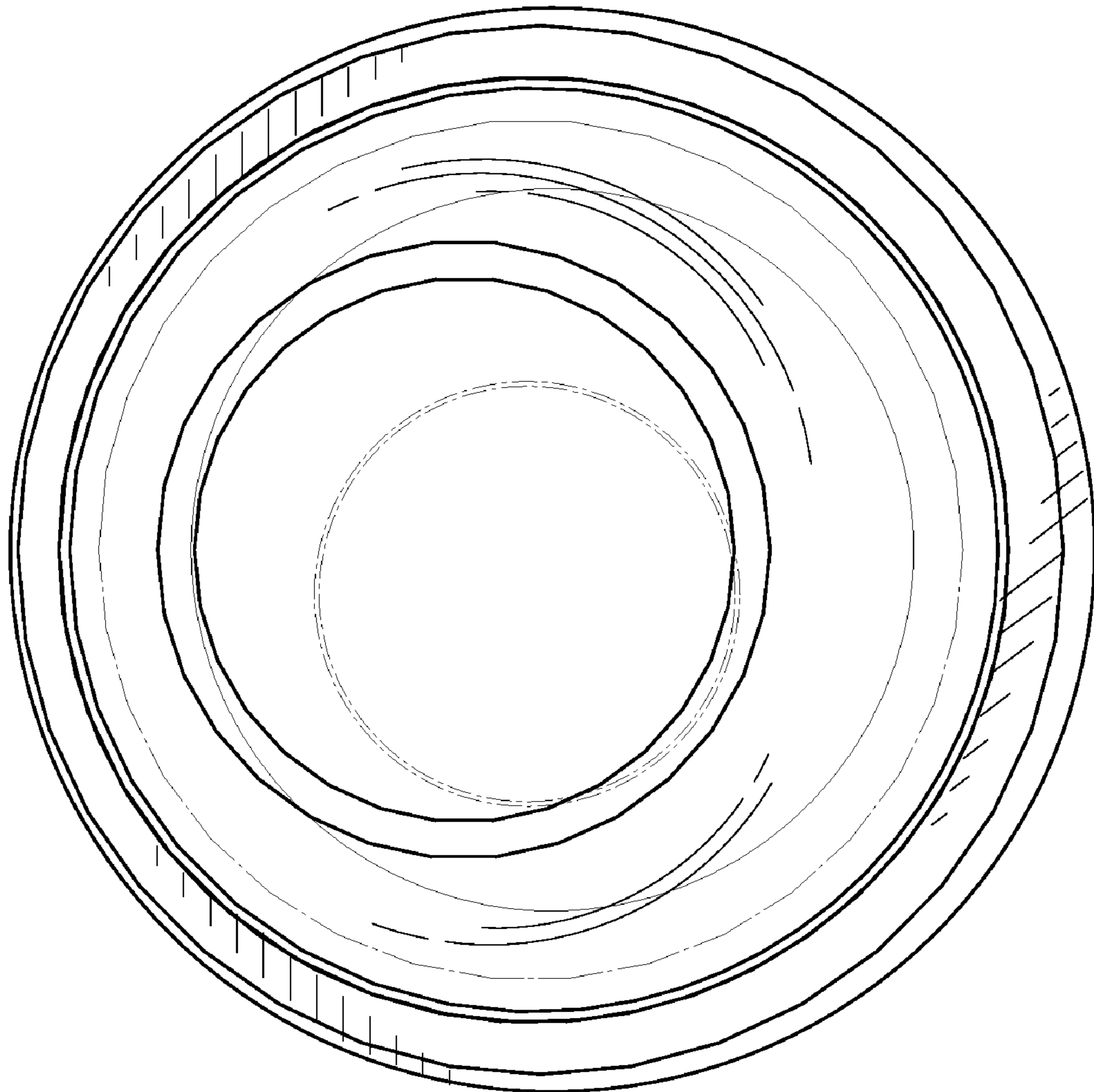

FIG. 6

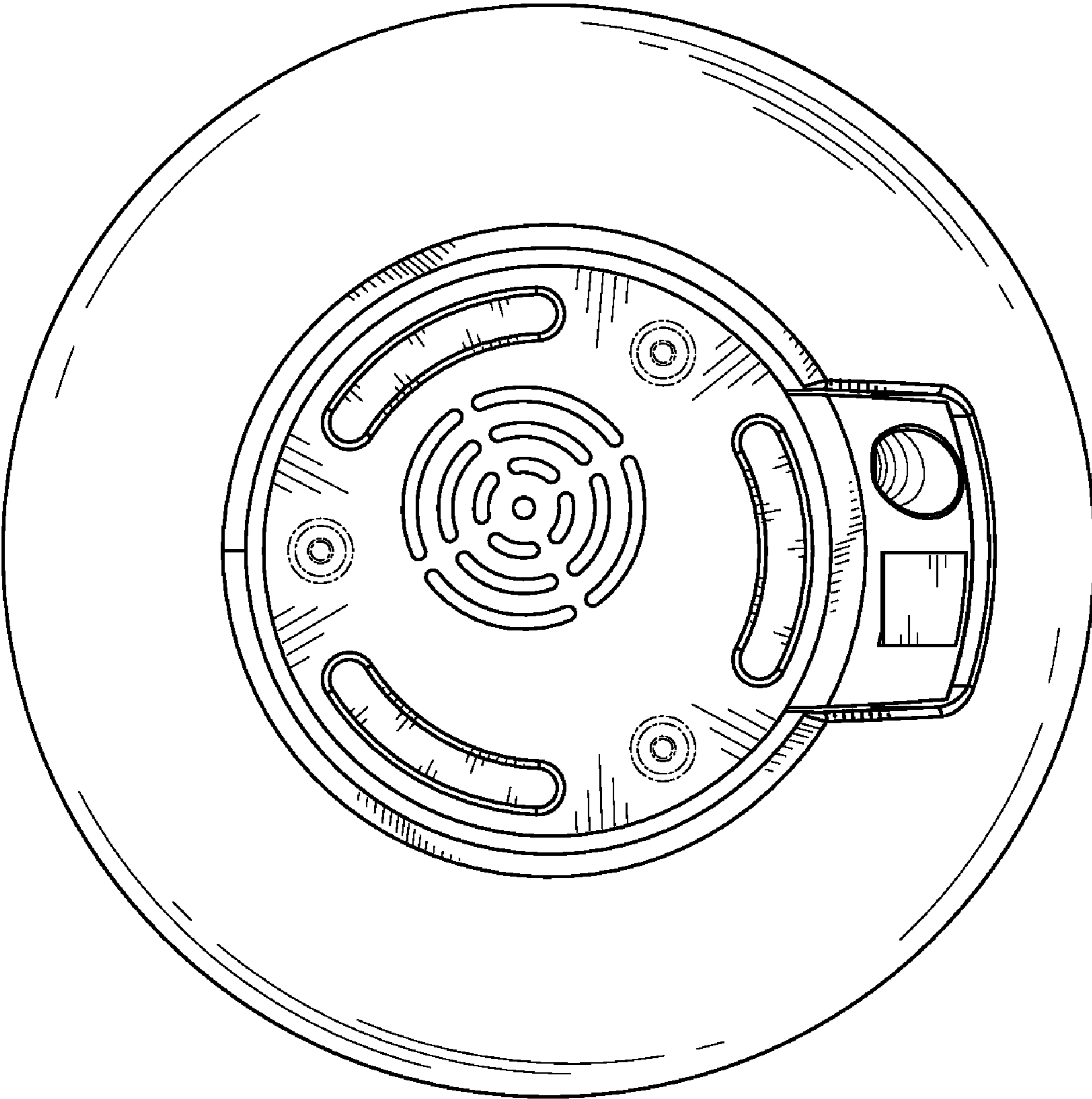

FIG. 7



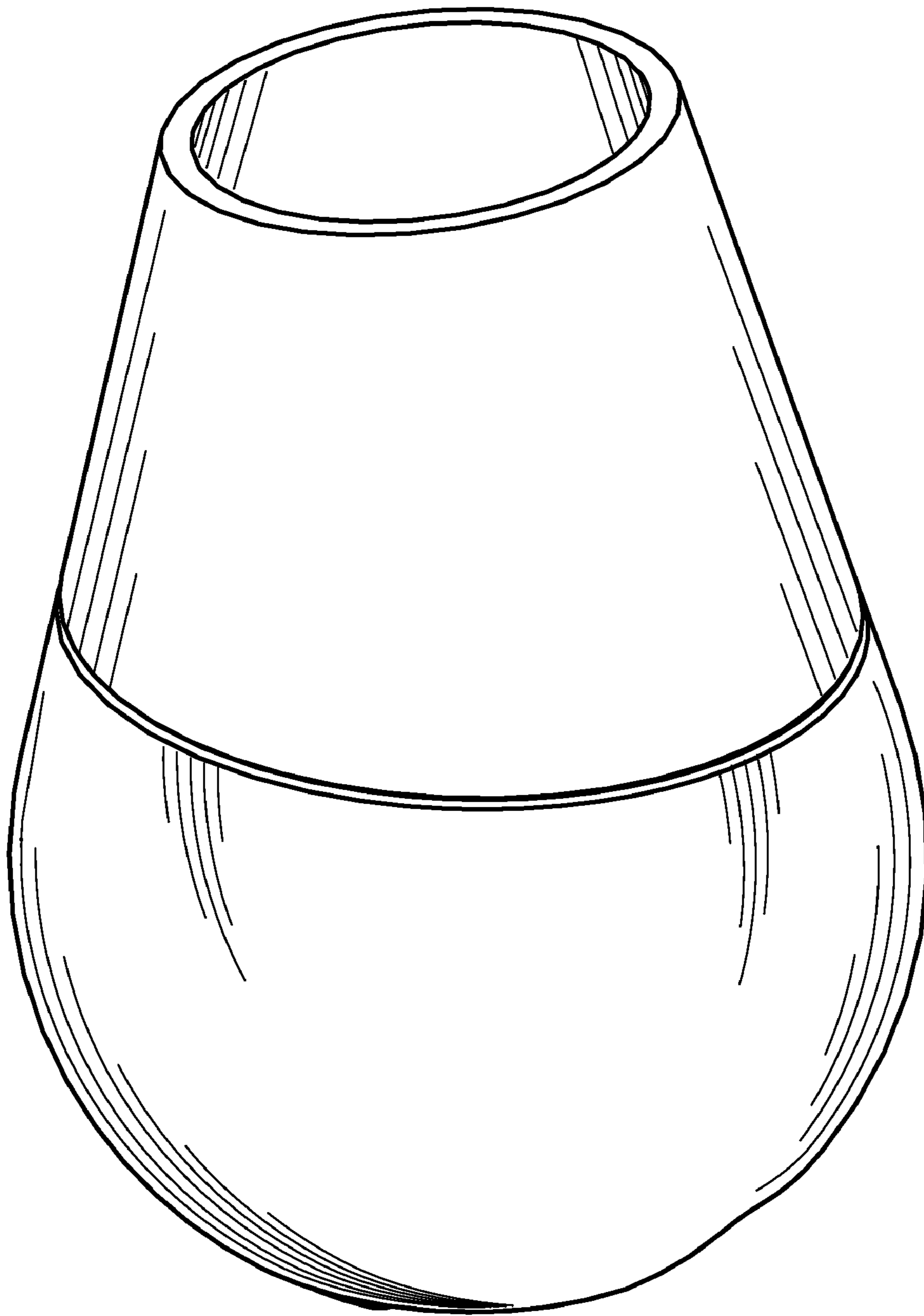

FIG. 8

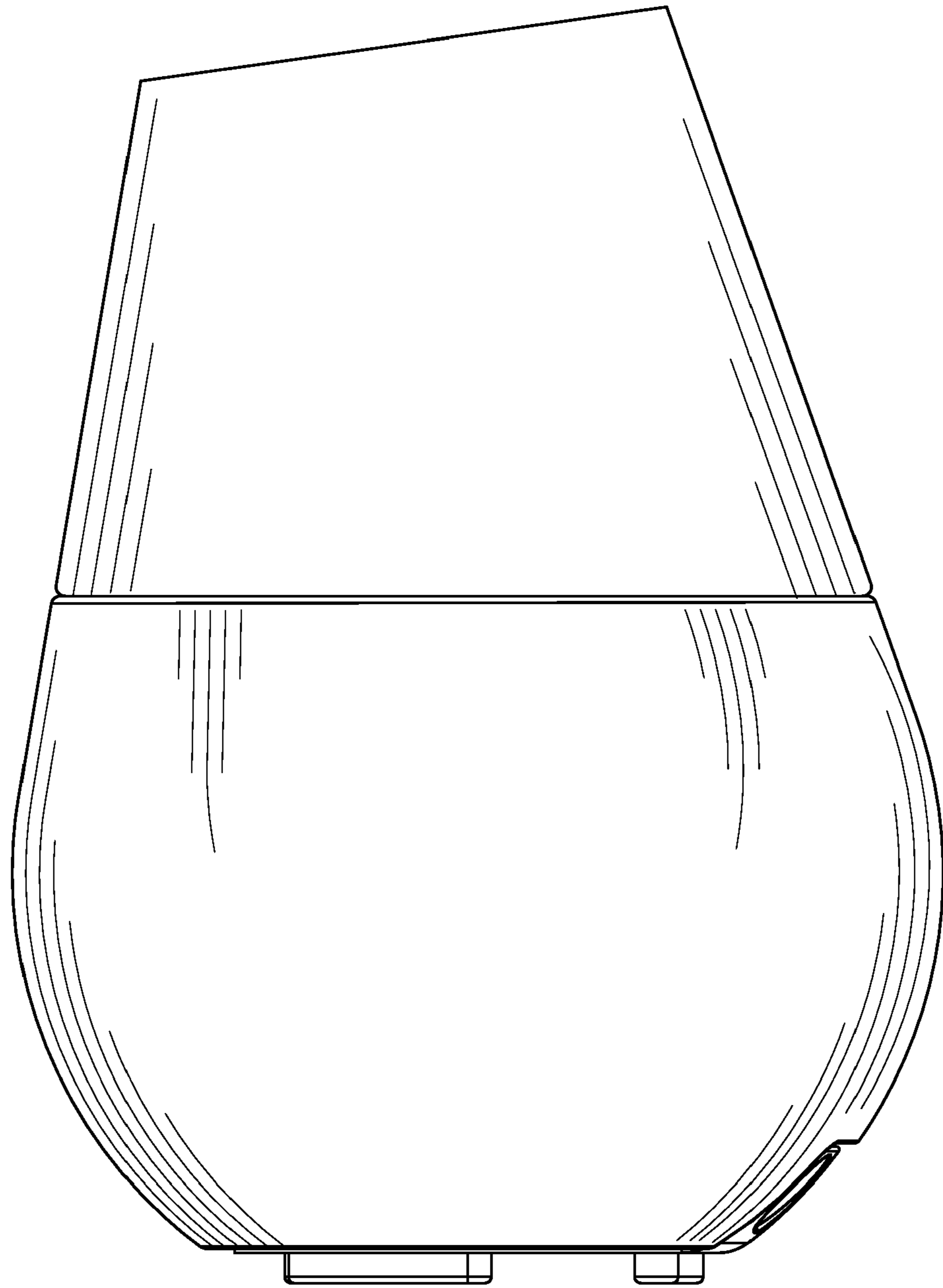

FIG. 9

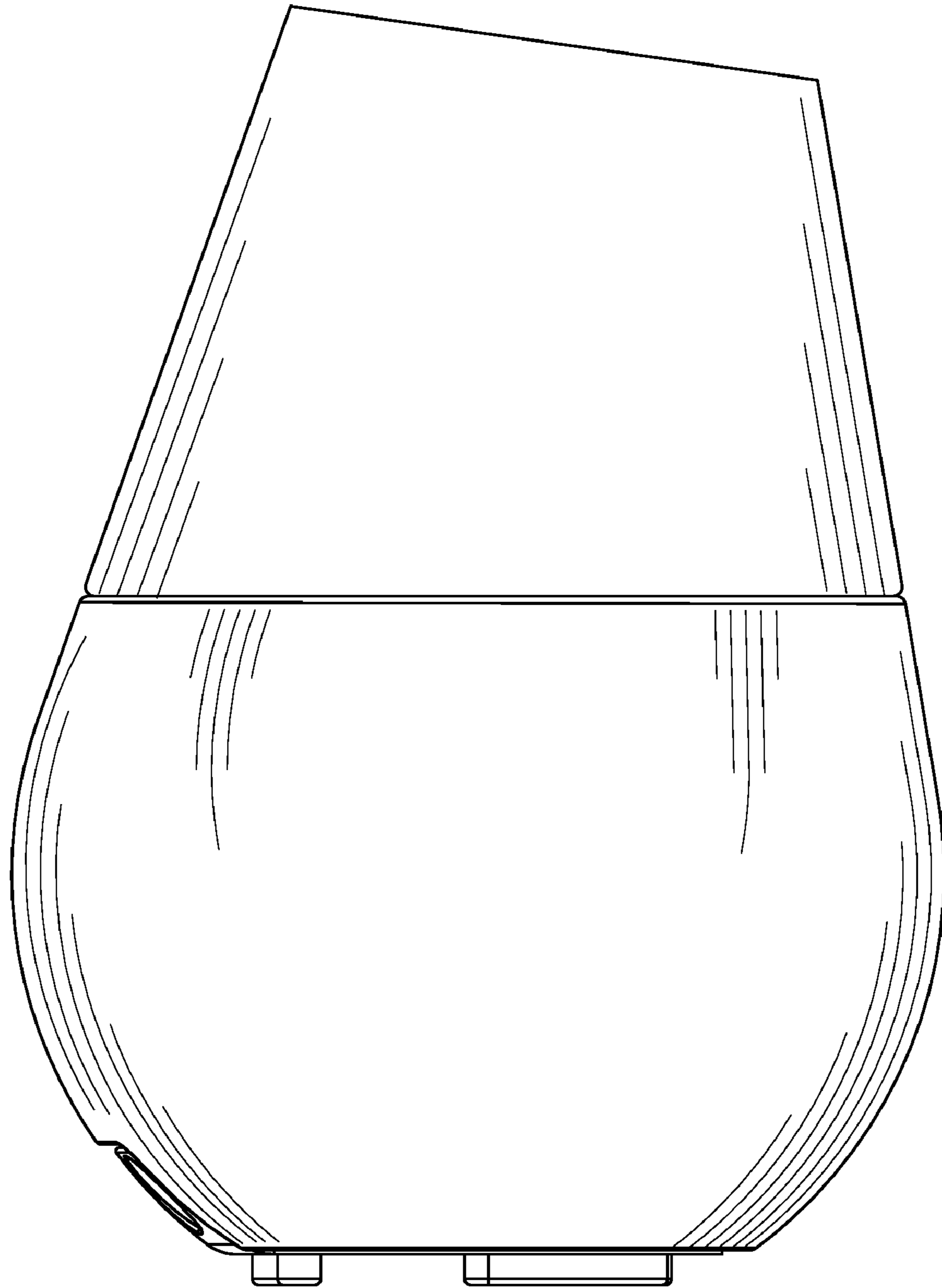

FIG. 10

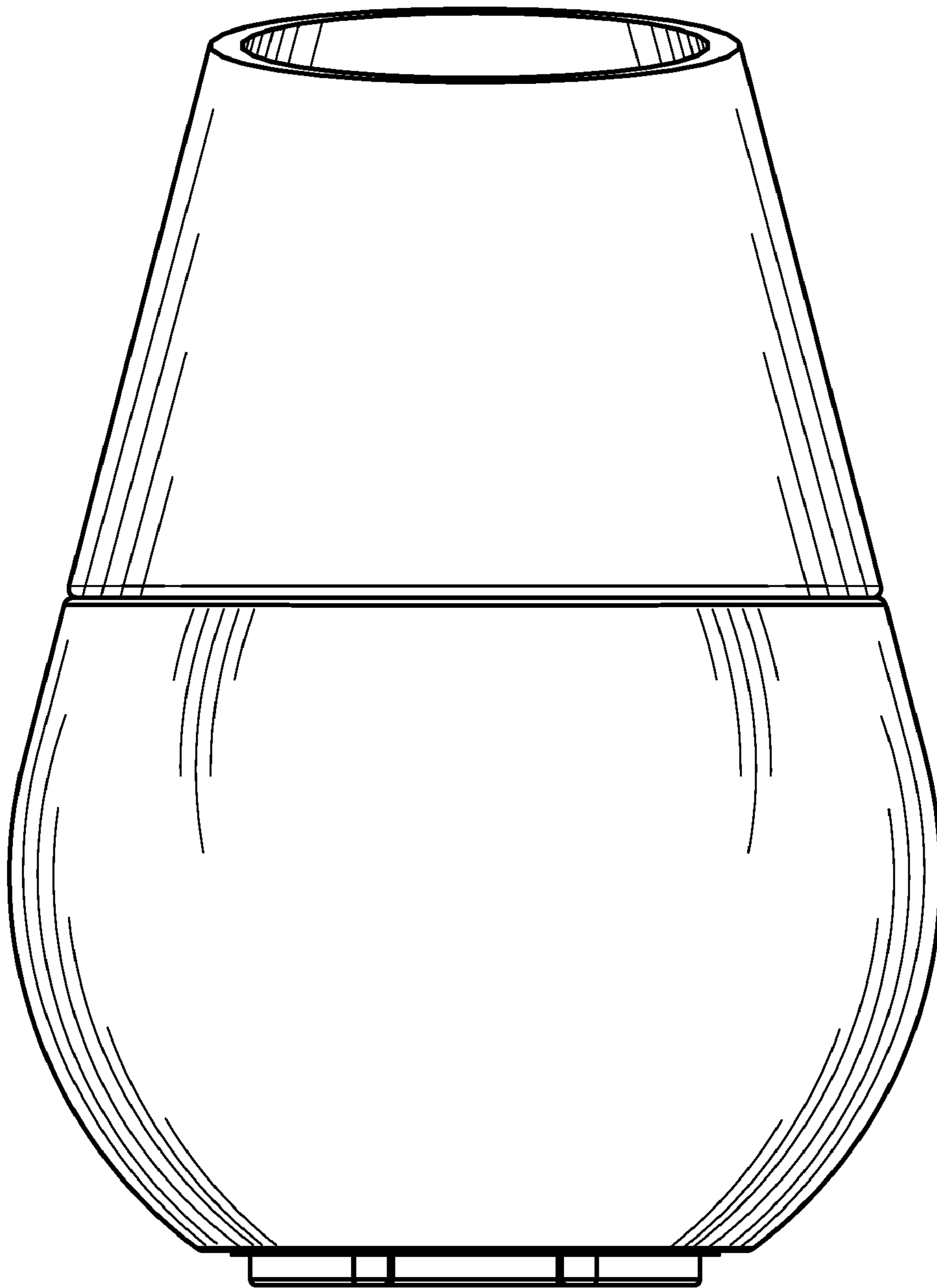

FIG. 11

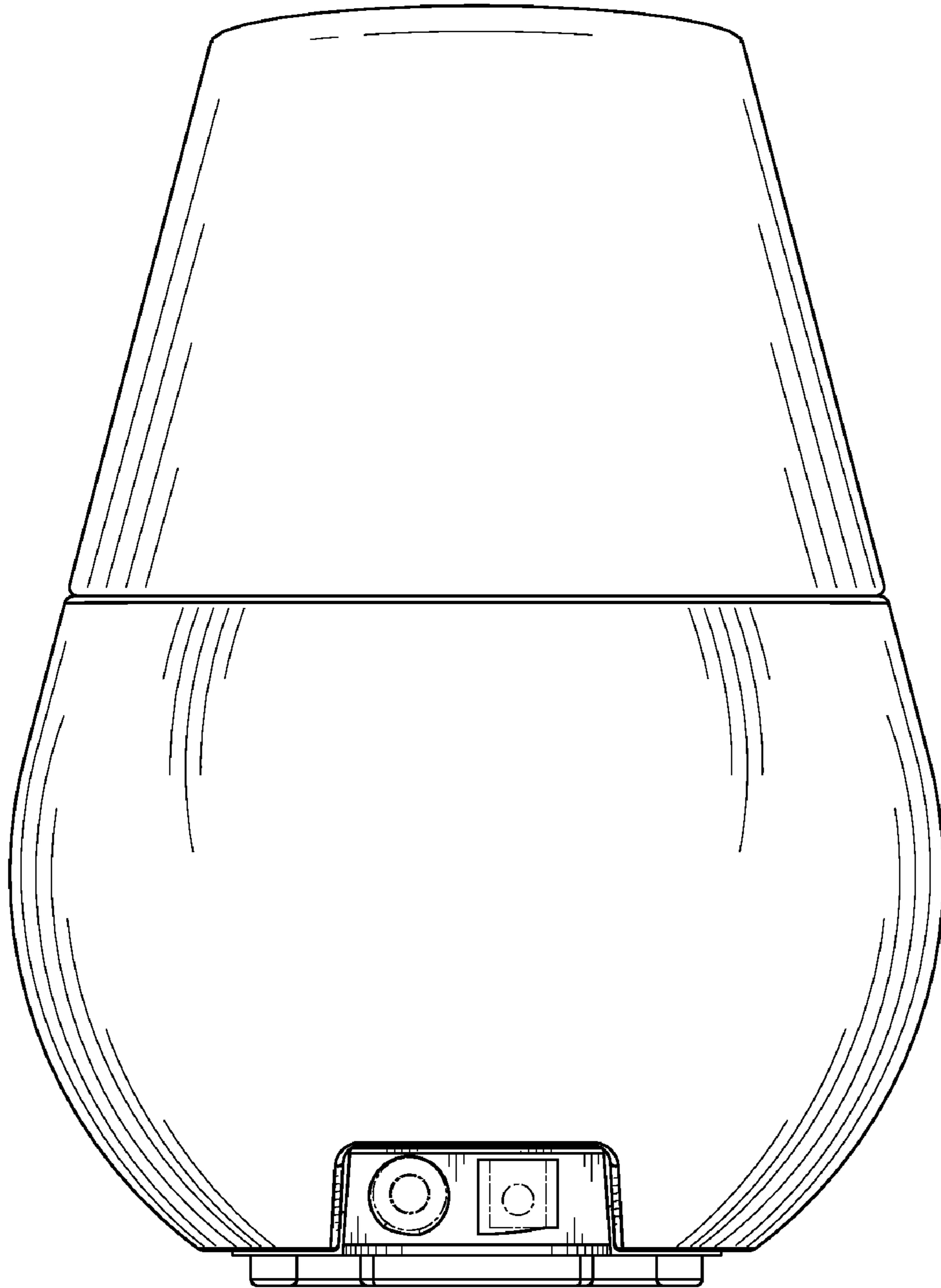

FIG. 12

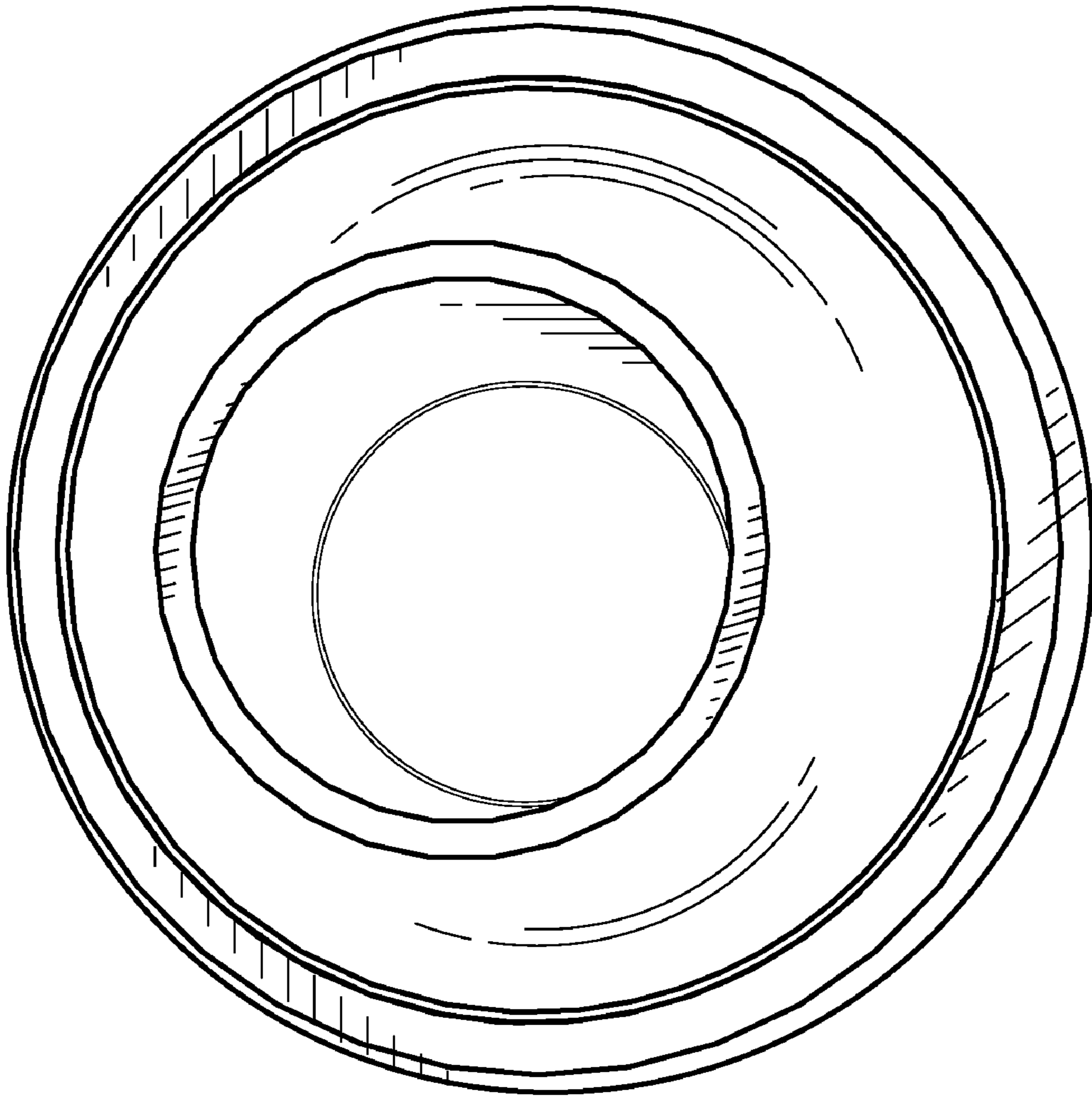

FIG. 13

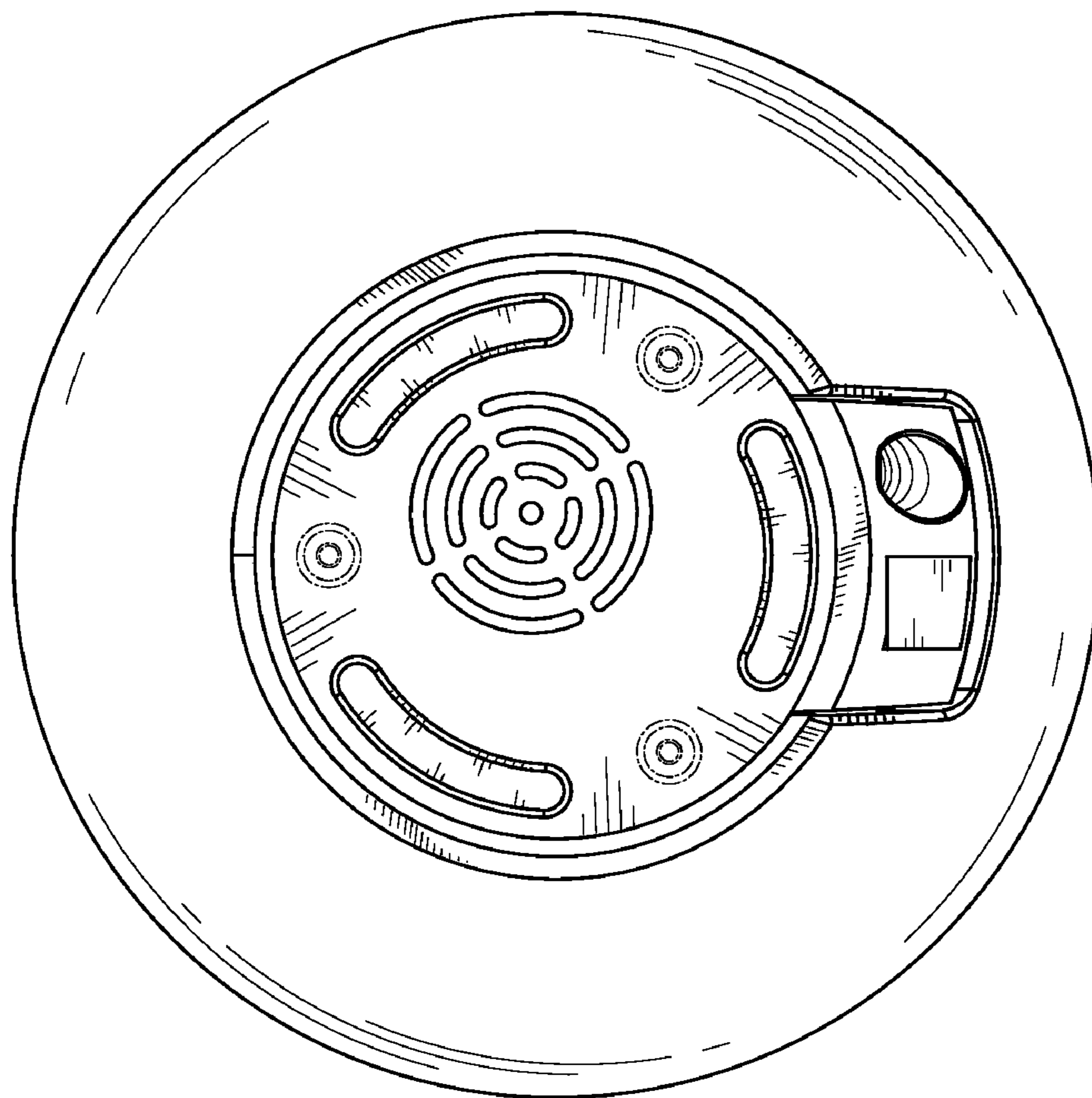

FIG. 14