



US00D613796S

(12) **United States Design Patent**
Kim

(10) **Patent No.:** **US D613,796 S**

(45) **Date of Patent:** **** *Apr. 13, 2010**

(54) **PAPER HOLDER**

(76) Inventor: **Tae Wan Kim**, Banpo-Apt 82-102,
Banpo-Dong, Seocho-Gu, Seoul (KR)
1300

(*) Notice: This patent is subject to a terminal disclaimer.

(**) Term: **14 Years**

(21) Appl. No.: **29/335,981**

(22) Filed: **Apr. 27, 2009**

(51) **LOC (9) Cl.** **19-06**

(52) **U.S. Cl.** **D19/86**

(58) **Field of Classification Search** D8/395,
D8/396; D19/32, 65, 86-92; 24/67 R, 67.1,
24/67.3, 67.5, 67.7, 67.9, 67.11, 511, 563,
24/570, DIG. 8, DIG. 9; 40/652, 658, 661.09,
40/666

See application file for complete search history.

(56) **References Cited**

U.S. PATENT DOCUMENTS

1,857,488	A *	5/1932	Weeks	24/563
D213,236	S *	1/1969	Zacharia	D19/86
3,597,813	A *	8/1971	Takahashi et al.	24/67.5
D251,124	S *	2/1979	Takeuchi	D19/65
D295,501	S *	5/1988	Brayford	D10/31
D298,216	S *	10/1988	Eisenberg	D8/395
4,947,524	A *	8/1990	Chang	24/67.9
D332,801	S *	1/1993	Peersmann	D19/75
5,309,605	A *	5/1994	Sato	24/67.9
5,745,962	A *	5/1998	Richter	24/488
D431,650	S *	10/2000	Guala et al.	D24/129
6,129,323	A *	10/2000	Mandokoro et al.	248/453
D453,294	S *	2/2002	Bitzer	D8/395
D484,914	S *	1/2004	Shields	D19/90
6,688,505	B1 *	2/2004	Bradley et al.	224/230
6,889,951	B1 *	5/2005	Shields	248/441.1
D530,192	S *	10/2006	Becerra	D8/395

D538,147	S *	3/2007	James	D8/395
7,255,313	B2 *	8/2007	Lane	248/221.41
D566,537	S *	4/2008	Wen-Po	D8/395

* cited by examiner

Primary Examiner—Elizabeth A Albert
(74) *Attorney, Agent, or Firm*—McKee, Voorhees & Sease, P.L.C.

(57) **CLAIM**

I claim the ornamental design for a paper holder, substantially as shown and described.

DESCRIPTION

FIG. 1 is a front perspective view of a paper holder showing the present invention.

FIG. 2 is a front elevational view thereof.

FIG. 3 is a rear elevational view thereof.

FIG. 4 is a side elevational view from the left side of FIG. 1.

FIG. 5 is a side elevational view from the right side of FIG. 1.

FIG. 6 is a top plan view thereof.

FIG. 7 is a bottom plan view thereof.

FIG. 8 is a front perspective view of an alternate paper holder showing the present invention.

FIG. 9 is a rear elevational view thereof.

FIG. 10 is a side elevational view from the left side of FIG. 8.

FIG. 11 is a side elevational view from the right side of FIG. 8.

FIG. 12 is a top plan view thereof; and,

FIG. 13 is a bottom plan view thereof.

FIG. 14 is a front perspective view of the paper holder in use. The broken lines showing a piece of paper in FIG. 14 are included for the purpose of illustrating environment and form no part of the claimed design.

1 Claim, 5 Drawing Sheets

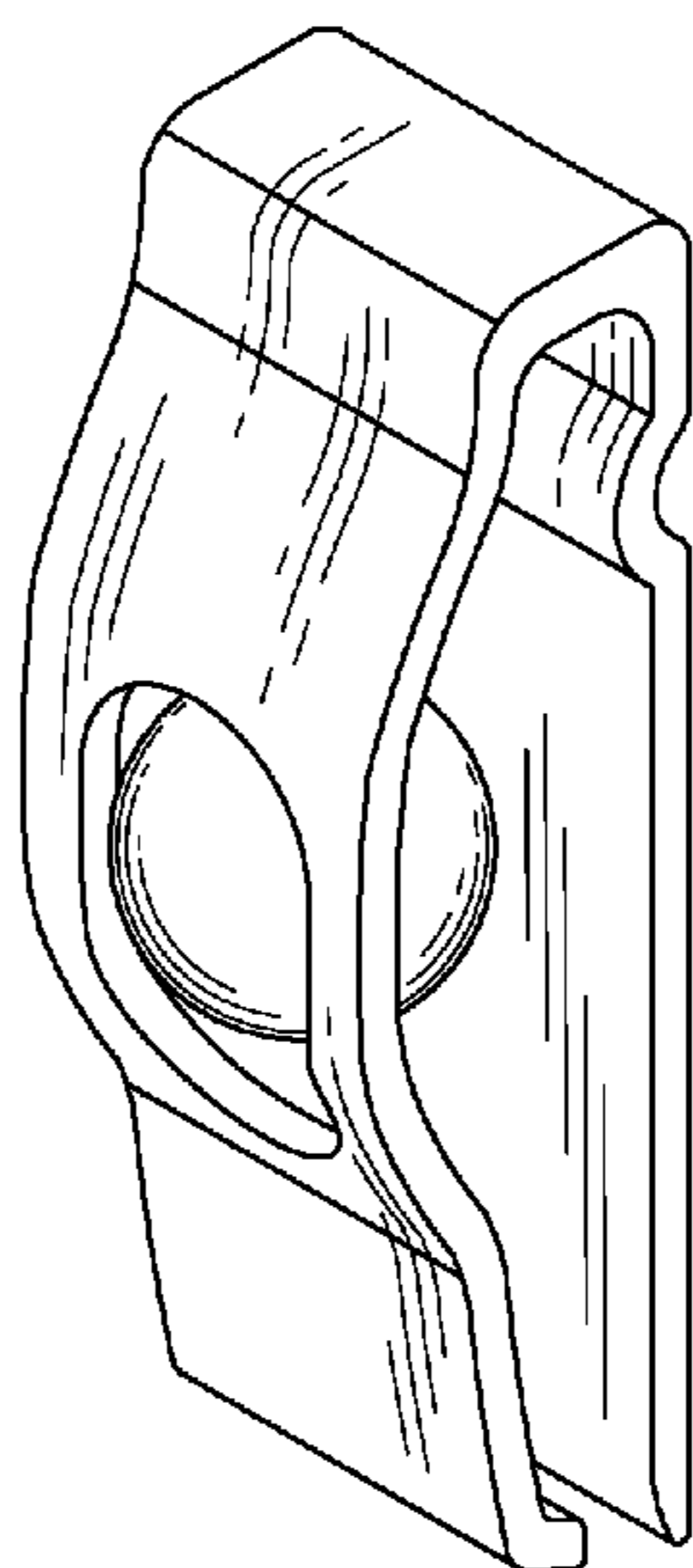

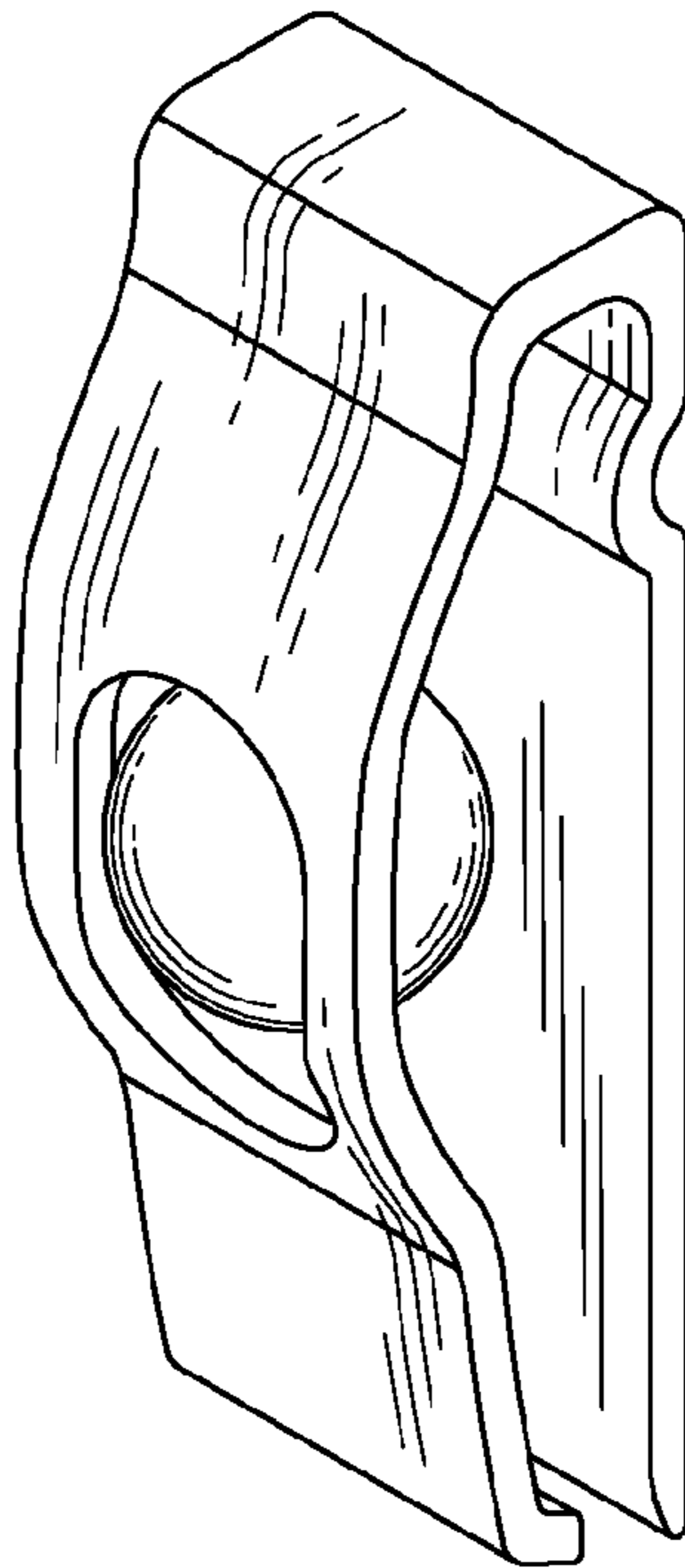

Fig. 1

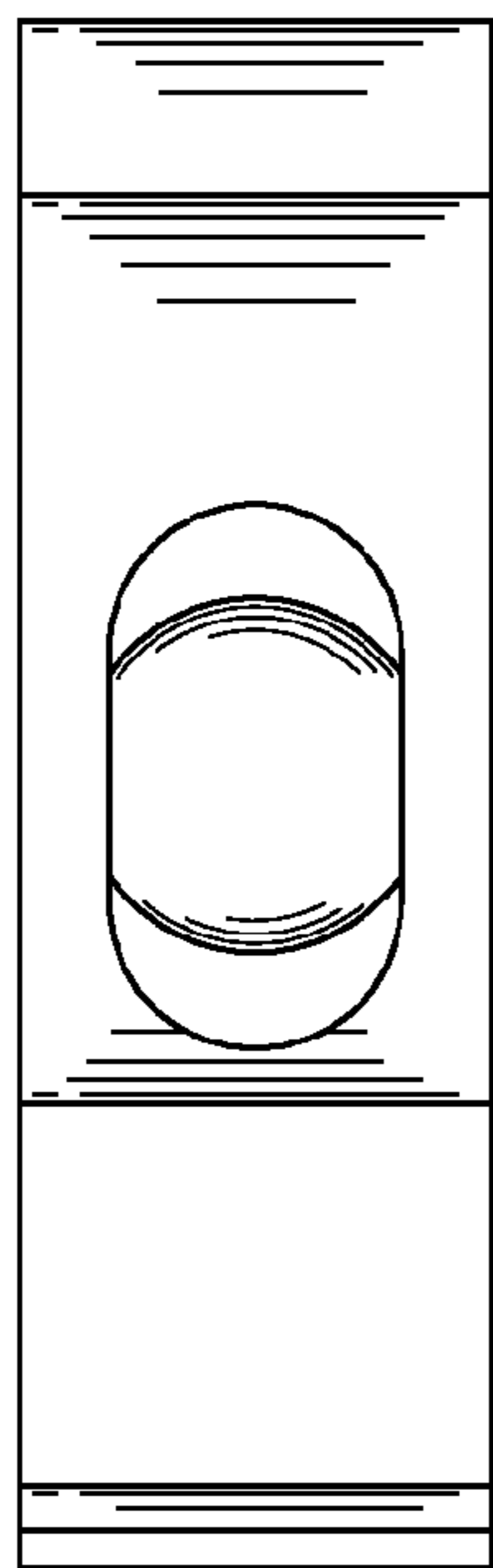

Fig. 2

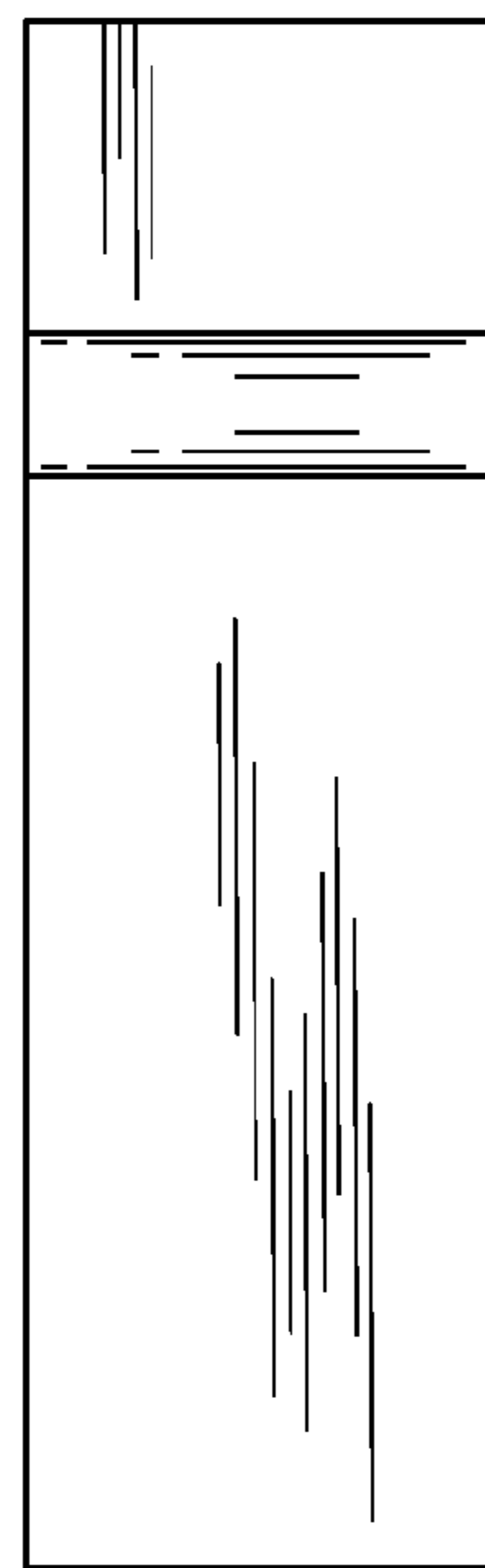

Fig. 3

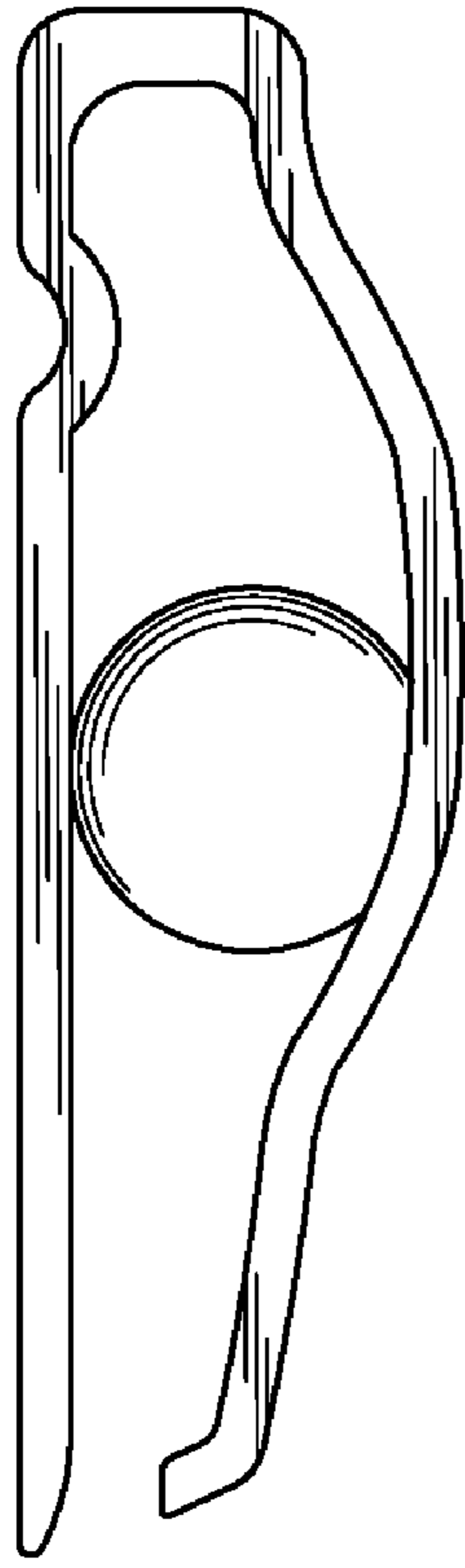

Fig. 4

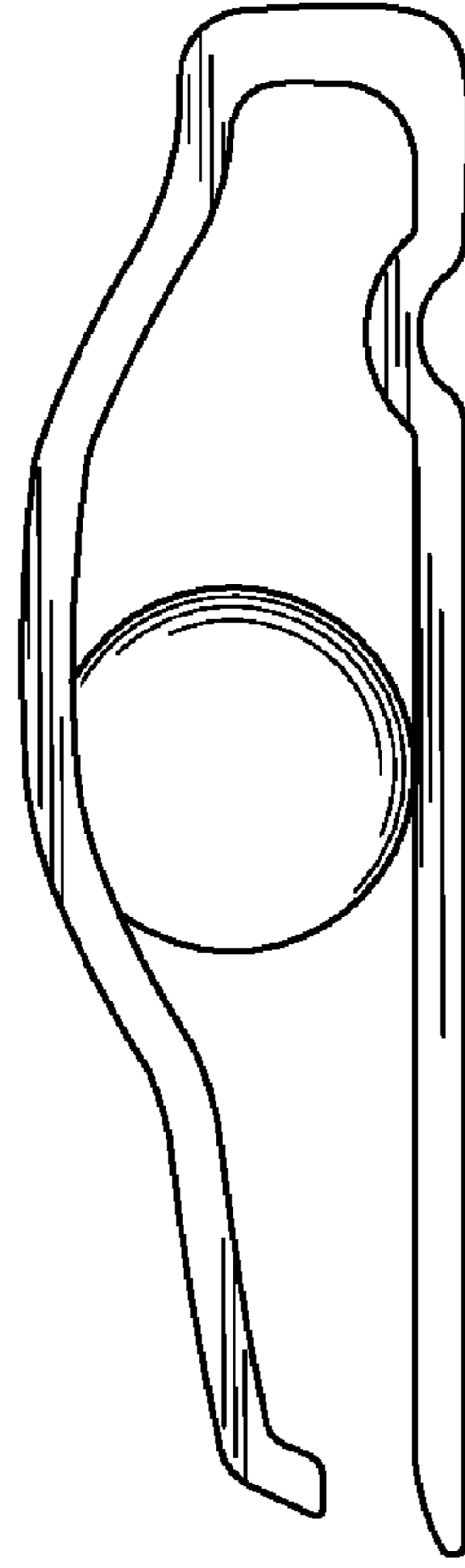

Fig. 5

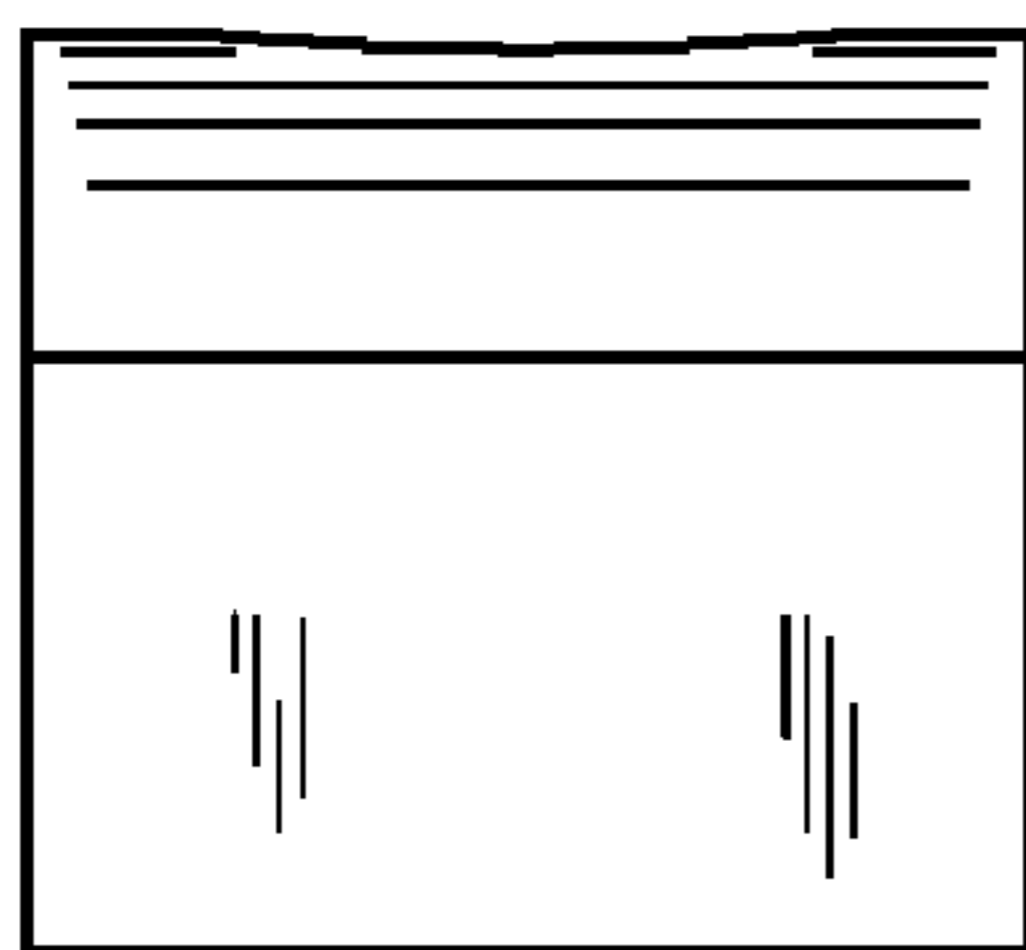

Fig. 6

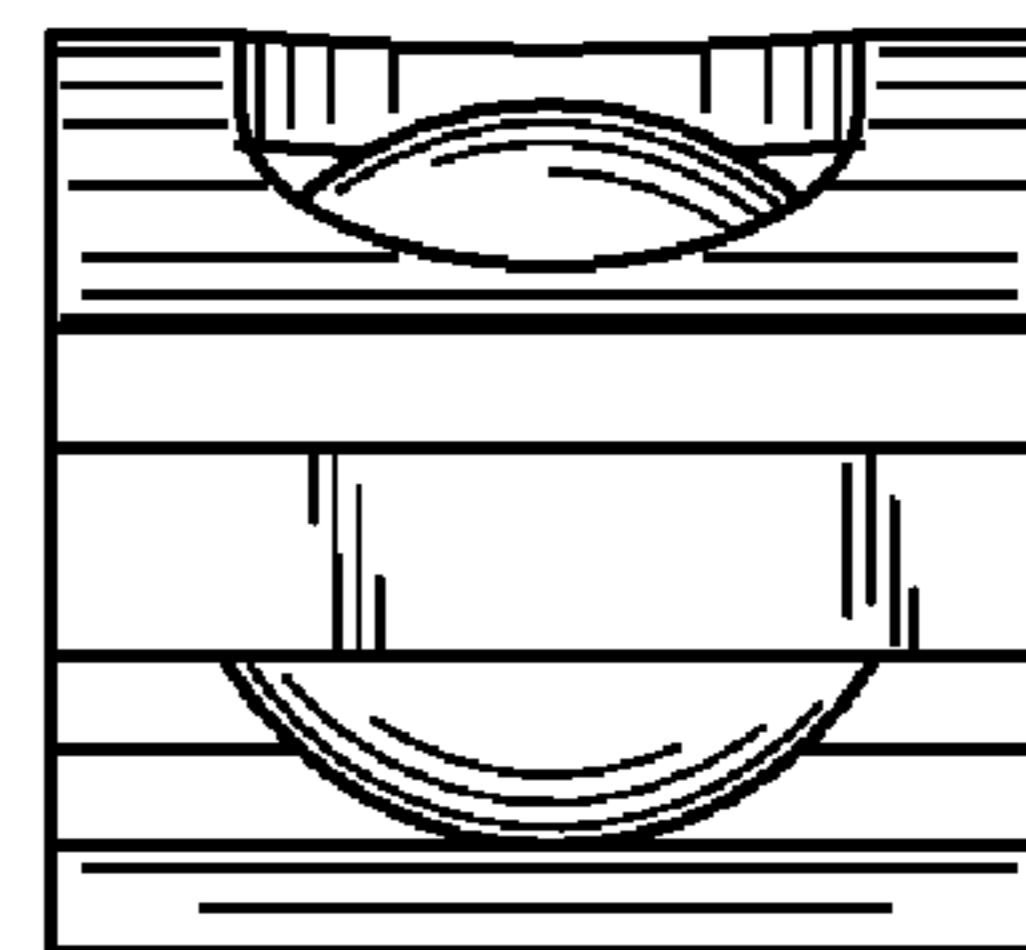

Fig. 7

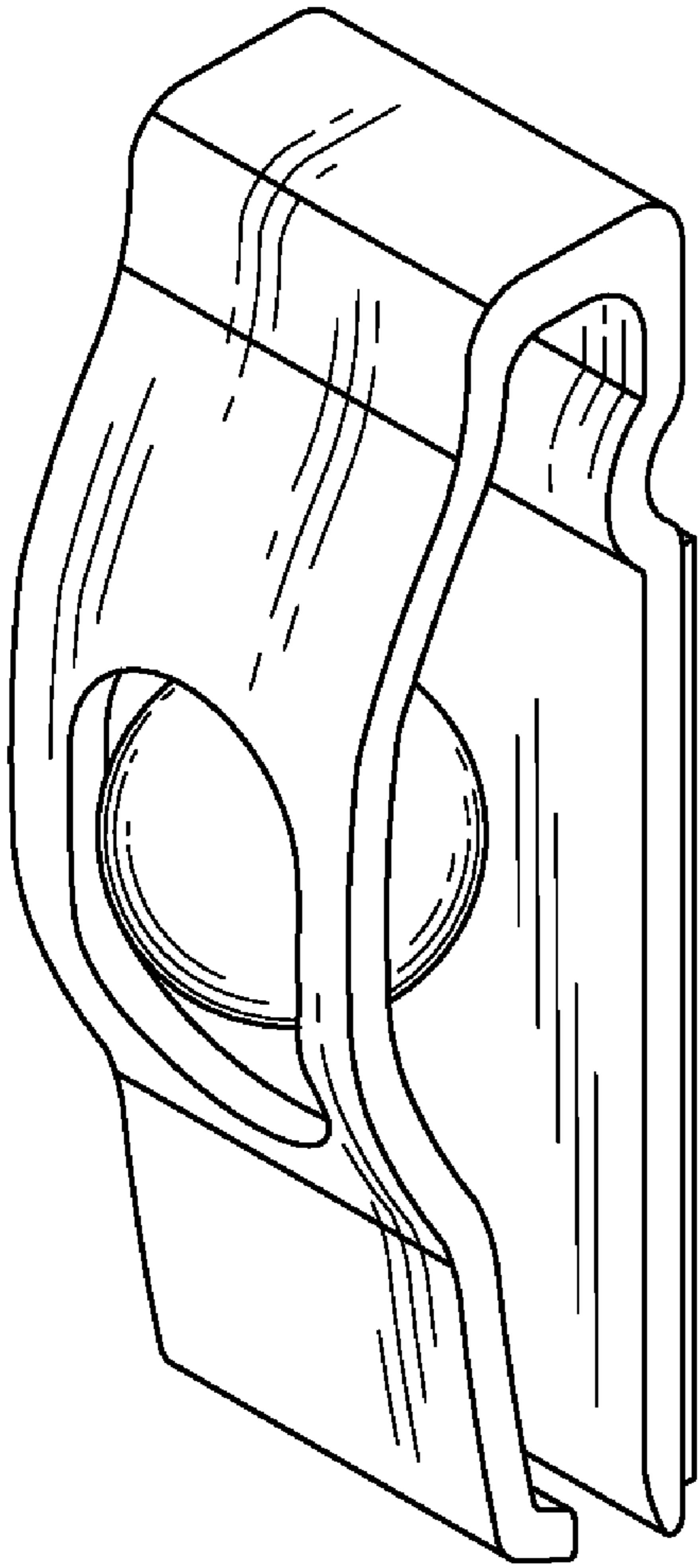

Fig. 8

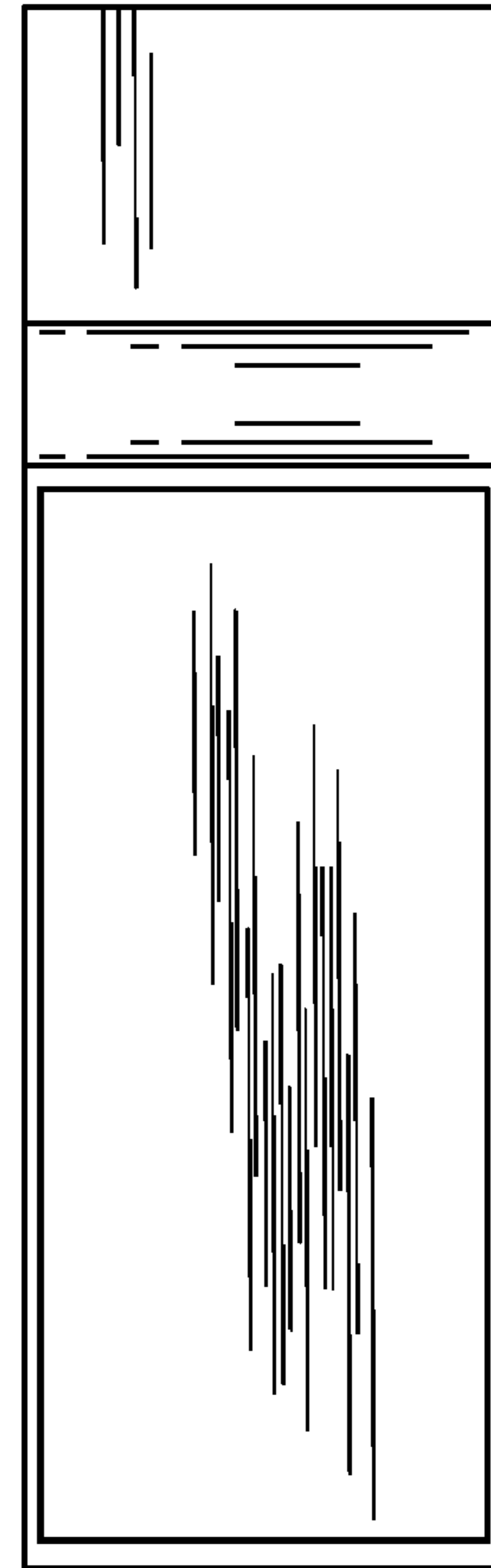

Fig. 9

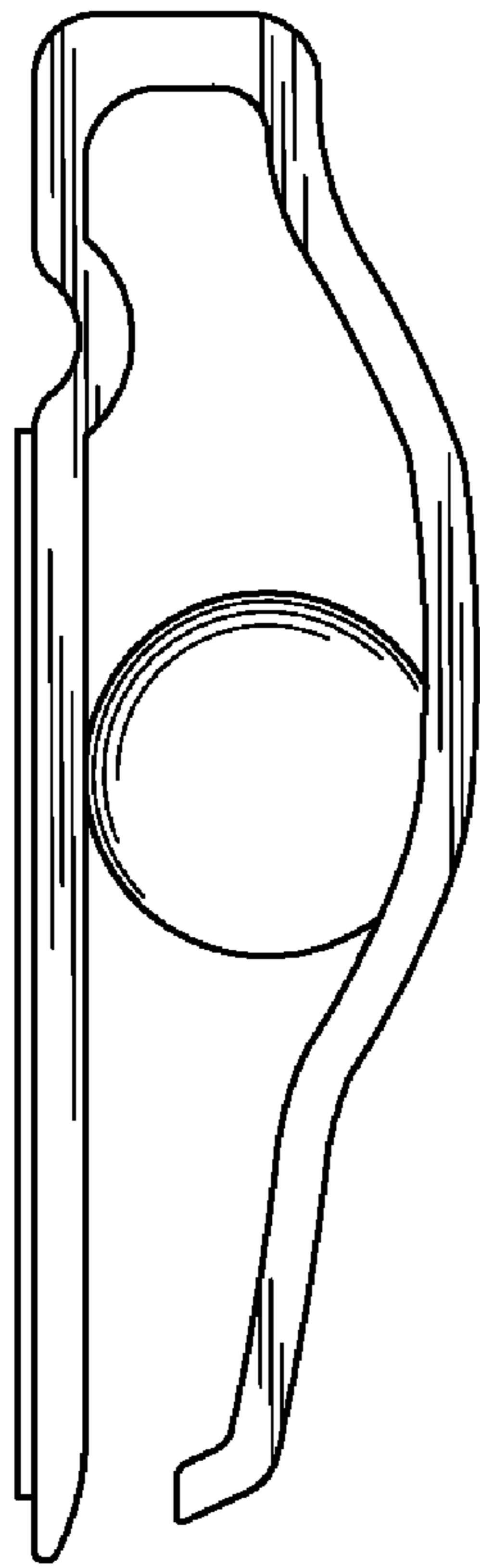

Fig. 10

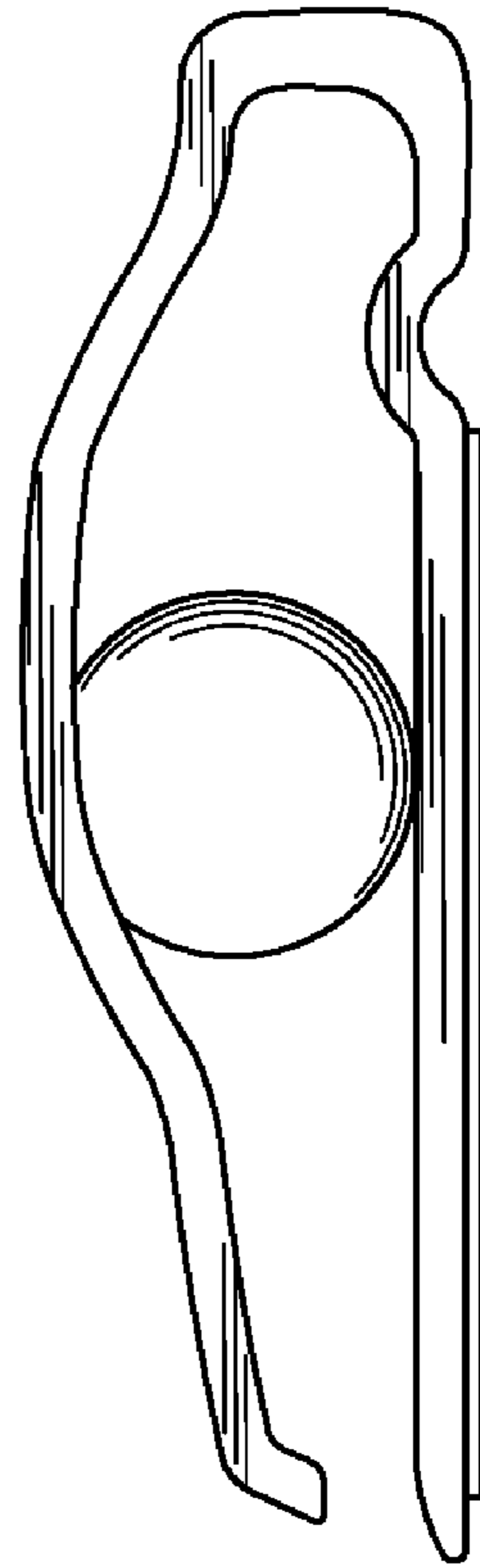

Fig. 11

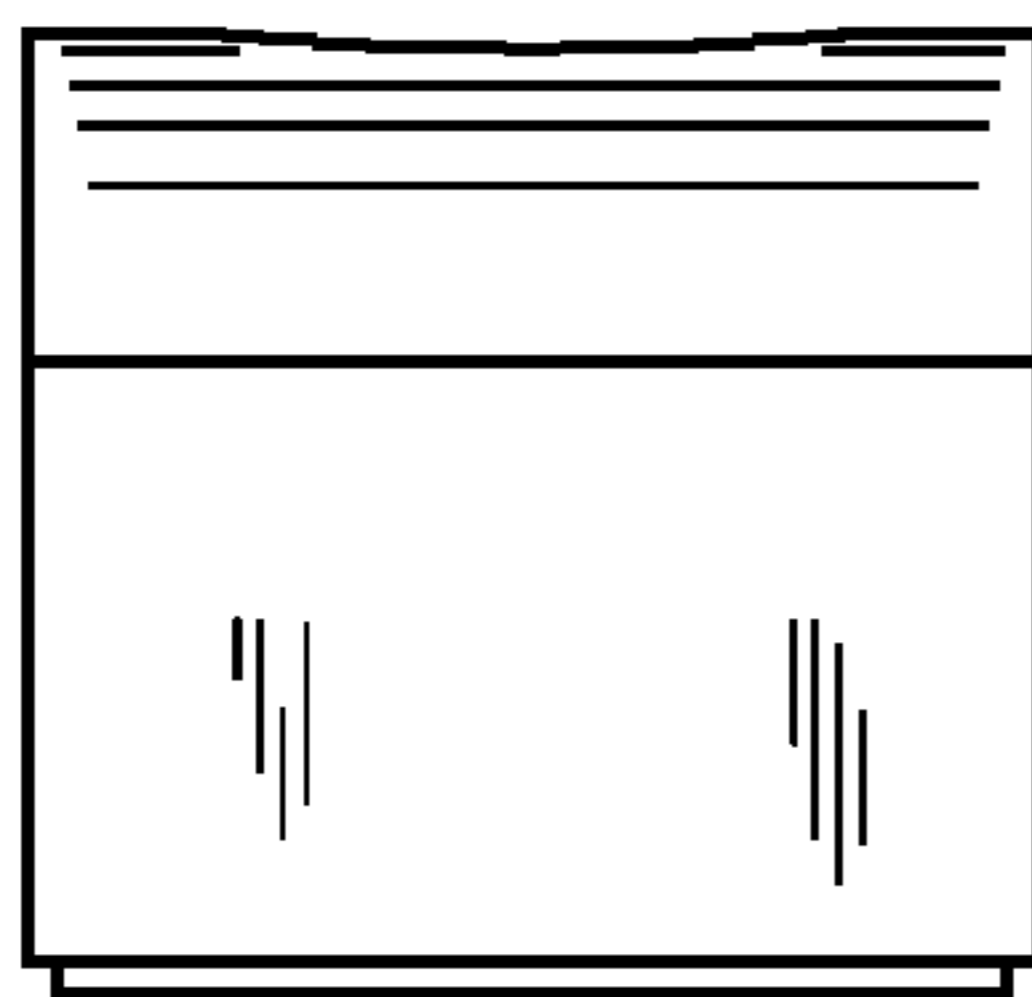

Fig. 12

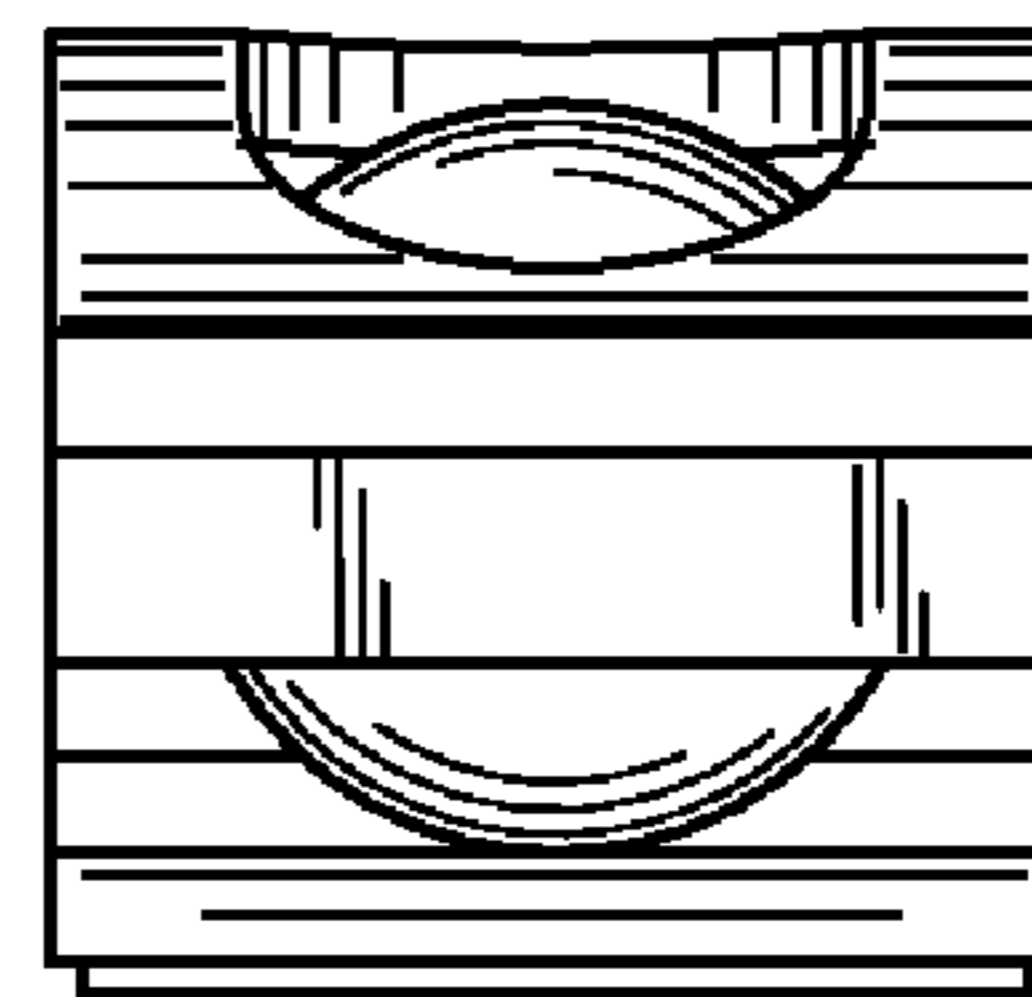

Fig. 13

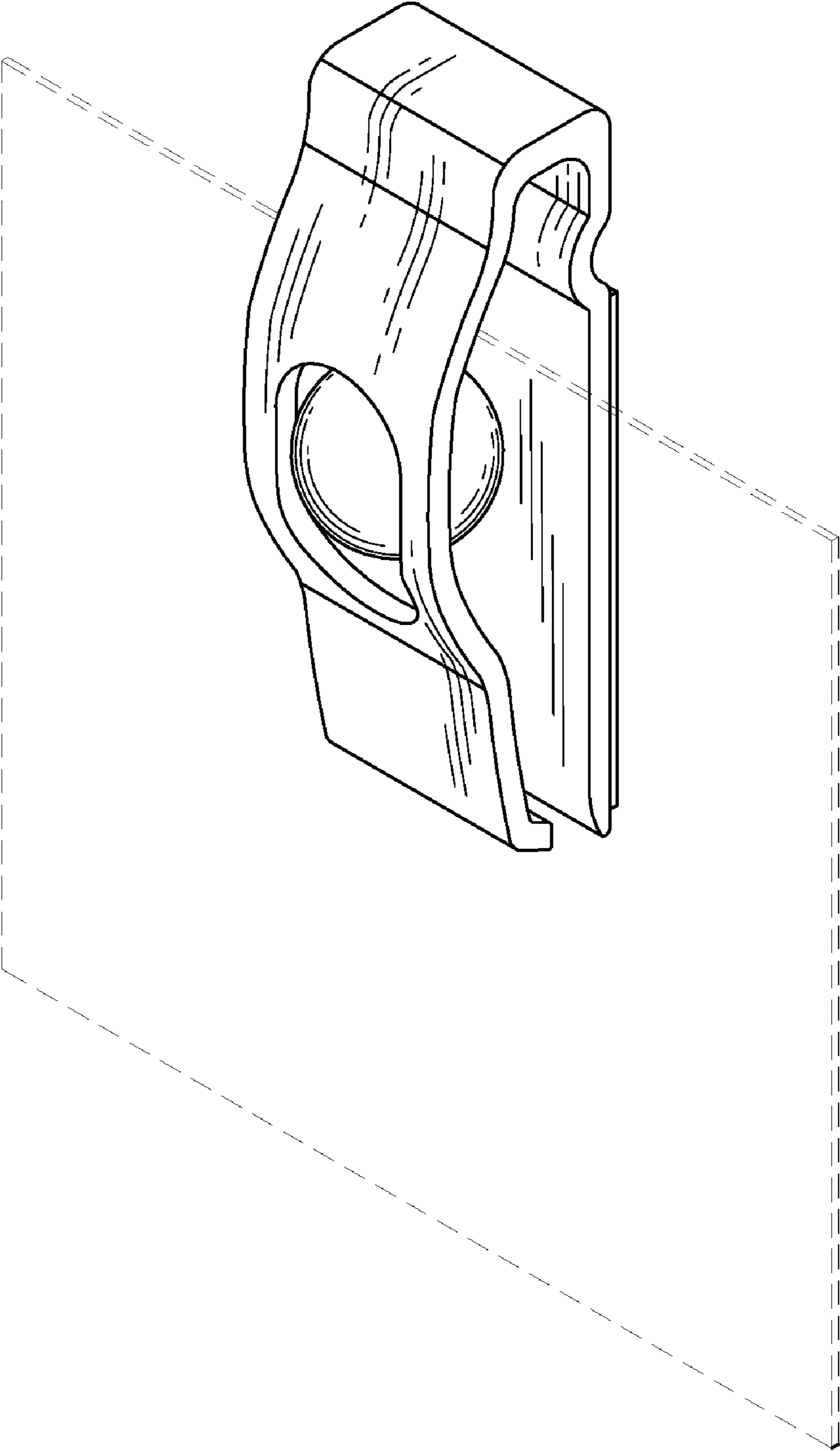

Fig. 14