



US00D613720S

(12) **United States Design Patent**
Kim et al.

(10) **Patent No.:** **US D613,720 S**
(45) **Date of Patent:** **** Apr. 13, 2010**

(54) **MOBILE PHONE**

(75) Inventors: **Min-Soo Kim**, Seoul (KR); **Yoon-Young Cho**, Seoul (KR); **Chang-Hwan Hwang**, Goyang-Si (KR)

(73) Assignee: **Samsung Electronics Co., Ltd.** (KR)

(**) Term: **14 Years**

(21) Appl. No.: **29/338,187**

(22) Filed: **Jun. 5, 2009**

(30) **Foreign Application Priority Data**

Apr. 16, 2009 (KR) 30-2009-0016349

(51) **LOC (9) Cl.** **14-03**

(52) **U.S. Cl.** **D14/138 AB**

(58) **Field of Classification Search** D14/138 AB,
D14/138 R, 138 AD, 345, 346, 147, 203.4,
D14/203.7, 203.2, 144; 455/575.3; 379/433.1,
379/433.11, 433.13; D21/517
See application file for complete search history.

(56) **References Cited**

U.S. PATENT DOCUMENTS

D476,968 S * 7/2003 Yokoyama D14/138 AB
D500,750 S * 1/2005 Arnholt et al. D14/138 AB
D536,686 S * 2/2007 Miyata D14/138 AB
D549,678 S * 8/2007 Kim et al. D14/138 AB
D556,723 S * 12/2007 Lee D14/138 AB
D560,184 S * 1/2008 Hunt et al. D14/138 AB
D565,531 S * 4/2008 Park et al. D14/138 AB
D567,785 S * 4/2008 Lee et al. D14/138 AB

D569,359 S * 5/2008 Park et al. D14/138 AB
D574,348 S * 8/2008 Mun D14/138 AB
D574,803 S * 8/2008 Oh et al. D14/138 AB
D575,753 S * 8/2008 Lee et al. D14/138 AB
D579,893 S * 11/2008 Suk et al. D14/138 AB
D580,389 S * 11/2008 Song et al. D14/138 AB
D581,895 S * 12/2008 Oh et al. D14/138 AB

(Continued)

OTHER PUBLICATIONS

Samsung E490 telephone, announced Nov. 2006, [online], [site visited Nov. 16, 2009]. Available from Internet, <URL: <http://www.gsmarena.com>>.*

(Continued)

Primary Examiner—Jeffrey D Asch
(74) *Attorney, Agent, or Firm*—NSIP Law

(57) **CLAIM**

The ornamental design for a mobile phone, as shown.

DESCRIPTION

FIG. 1 is a perspective view of a mobile phone;
FIG. 2 is a front view of the mobile phone of FIG. 1;
FIG. 3 is a rear view of the mobile phone of FIG. 1;
FIG. 4 is a left-side view of the mobile phone of FIG. 1;
FIG. 5 is a right-side view of the mobile phone of FIG. 1;
FIG. 6 is a top plan view of the mobile phone of FIG. 1;
FIG. 7 is a bottom plan view of the mobile phone of FIG. 1;
and,
FIG. 8 is a front open view of the mobile phone of FIG. 1.

1 Claim, 6 Drawing Sheets

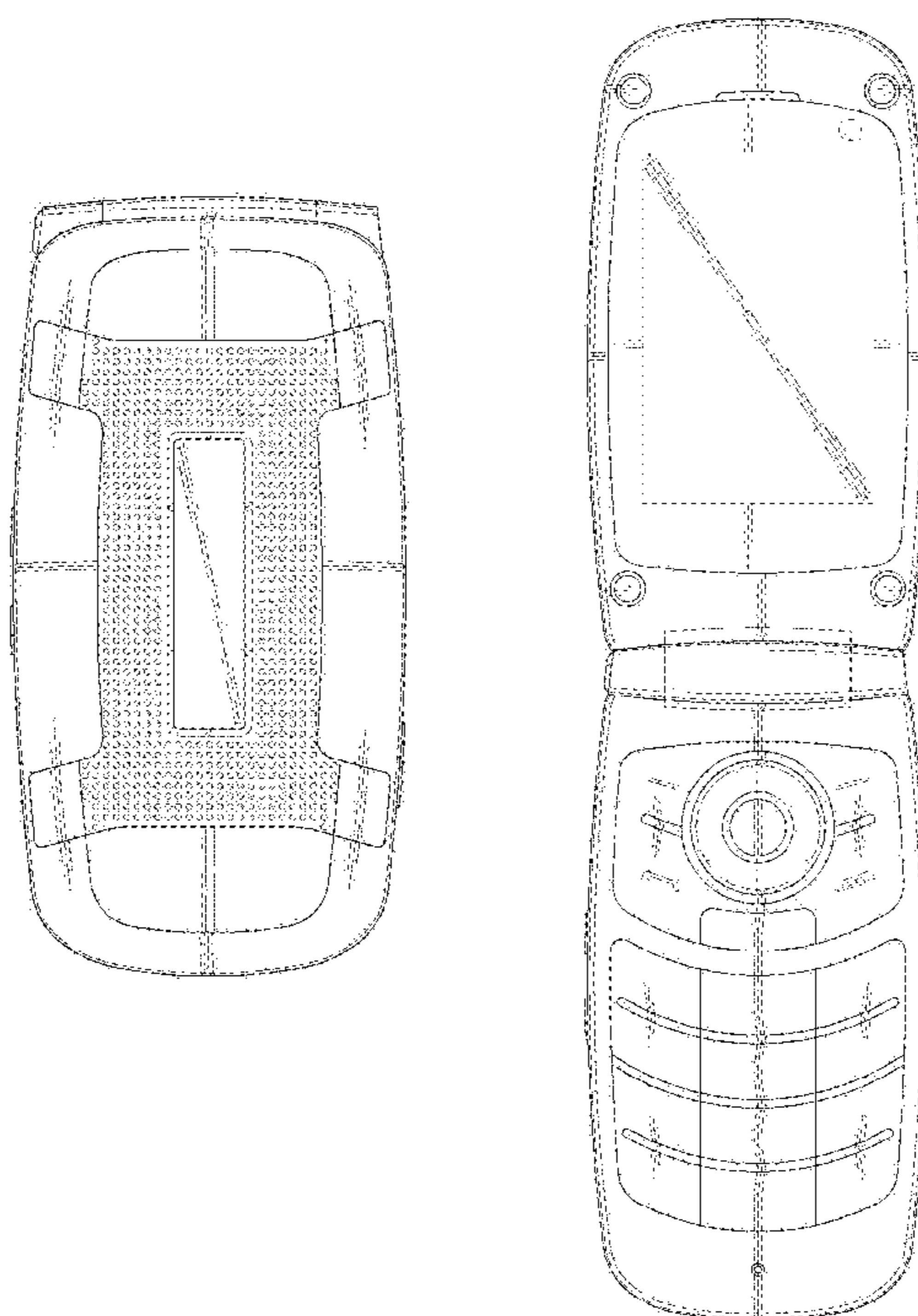

US D613,720 S

Page 2

U.S. PATENT DOCUMENTS

D583,787 S * 12/2008 Kim et al. D14/138 AB
D584,277 S * 1/2009 Nishikawa D14/138 AB
D584,278 S * 1/2009 Yoshihara D14/138 AB
D585,415 S * 1/2009 Lim et al. D14/138 AB
D587,673 S * 3/2009 Kim et al. D14/138 AB
D590,795 S * 4/2009 Tkachuk D14/138 AB
D591,707 S * 5/2009 Wozniak D14/138 AB
D591,708 S * 5/2009 Wozniak D14/138 AB
D593,533 S * 6/2009 Seo D14/138 AB
D598,884 S * 8/2009 Millora et al. D14/138 AB

2002/0006809 A1* 1/2002 Kubo et al. 455/550

OTHER PUBLICATIONS

Samsung A837 Rugby telephone, announced Sep. 2008, [online], [site visited Nov. 16, 2009]. Available from Internet, <URL: <http://www.gsmarena.com>>.*

Sony Ericsson W710 telephone, announced May 2006, [online], [site visited Nov. 16, 2009]. Available from Internet, <URL: <http://www.gsmarena.com>>.*

Alcatel OT-C701 telephone, announced Feb. 2007, [online], [site visited Nov. 16, 2009]. Available from Internet, <URL: <http://www.gsmarena.com>>.*

* cited by examiner

FIG. 1

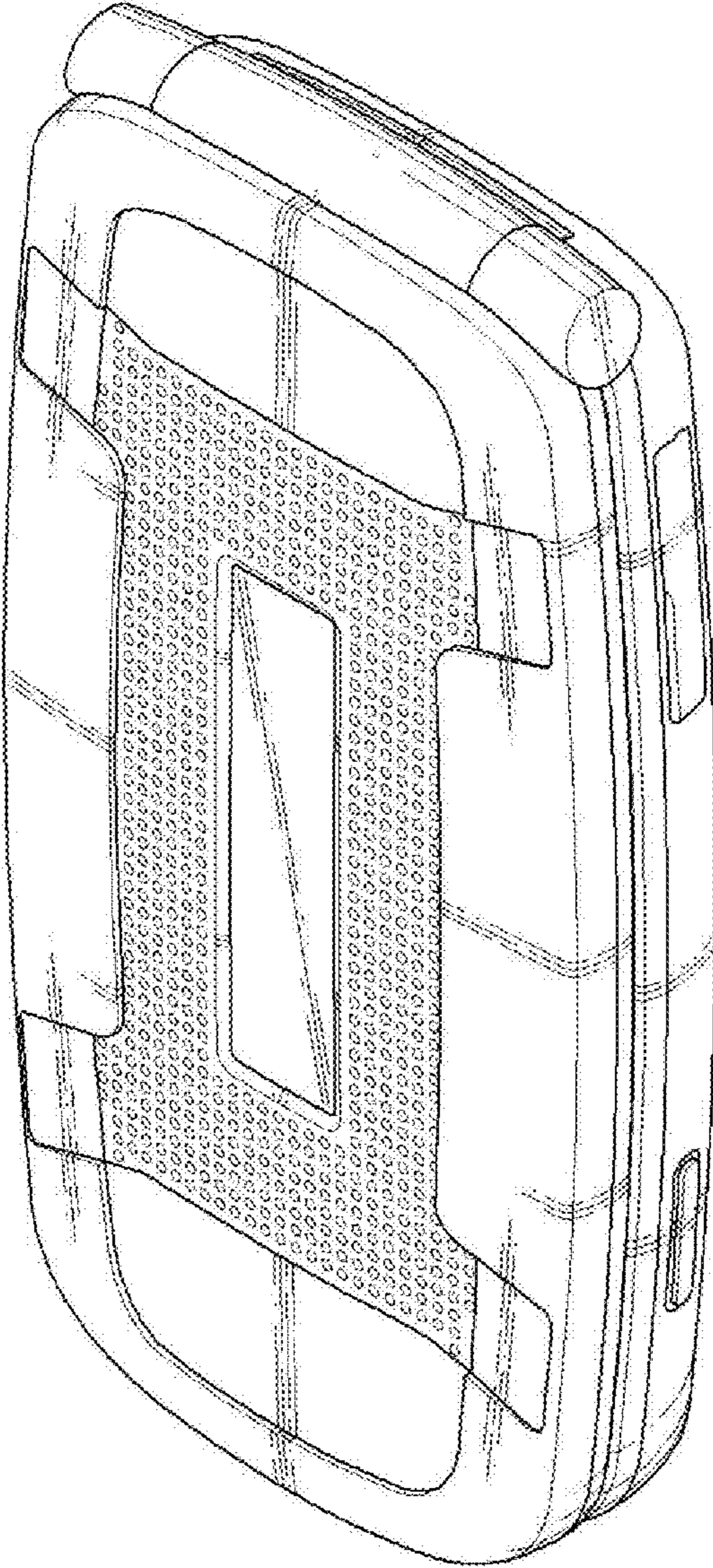

FIG. 2

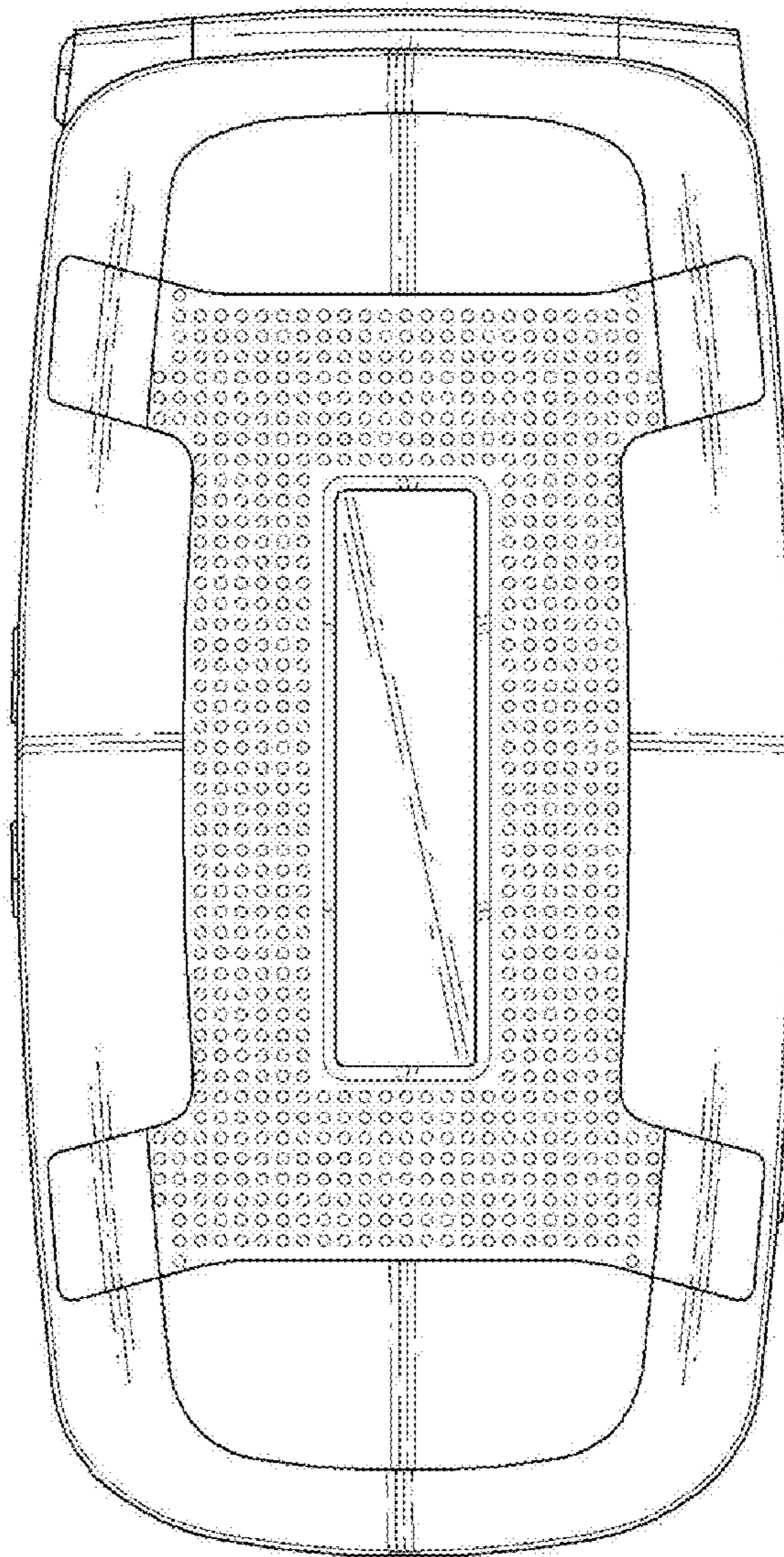

FIG. 3

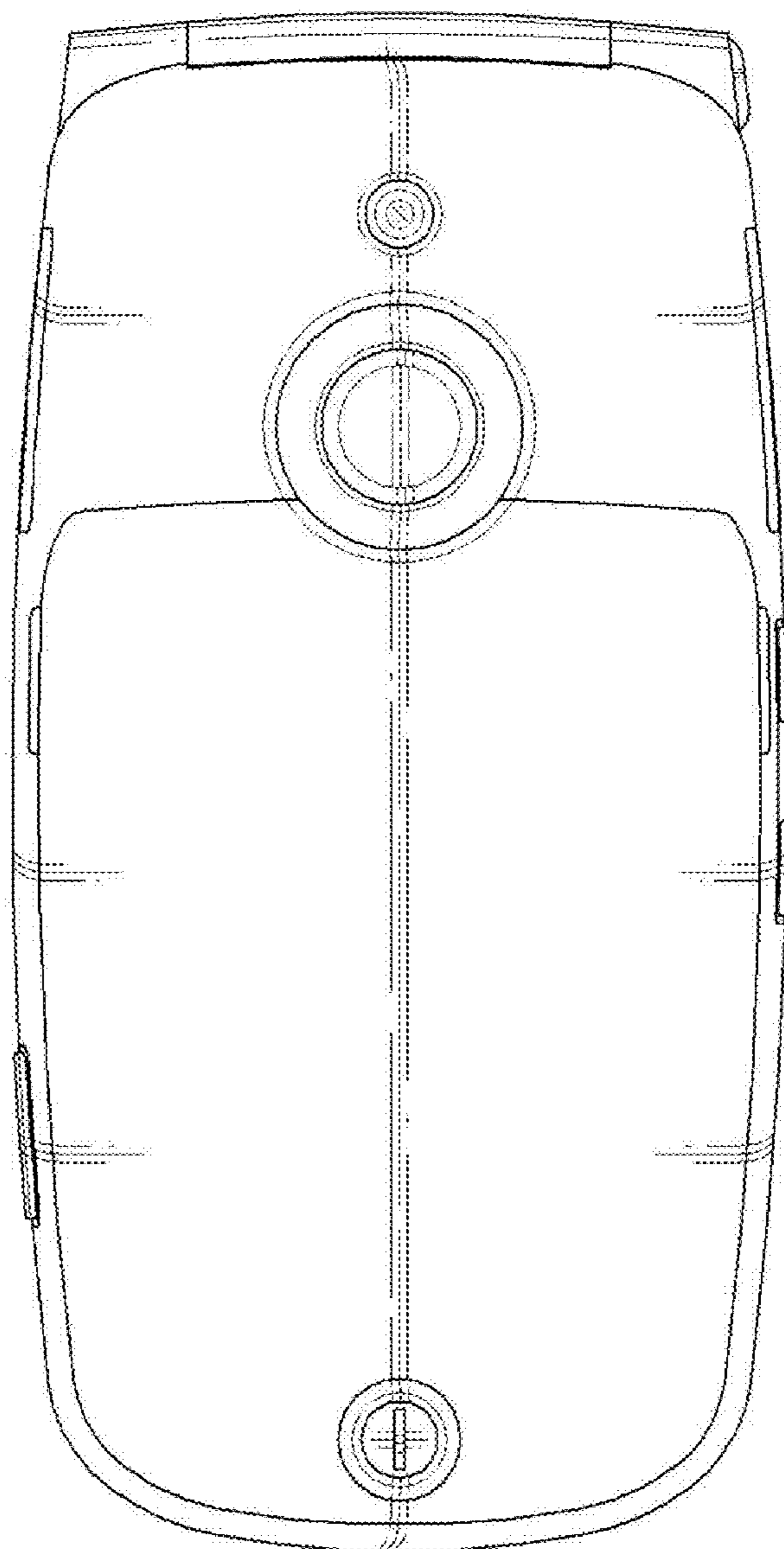

FIG. 4

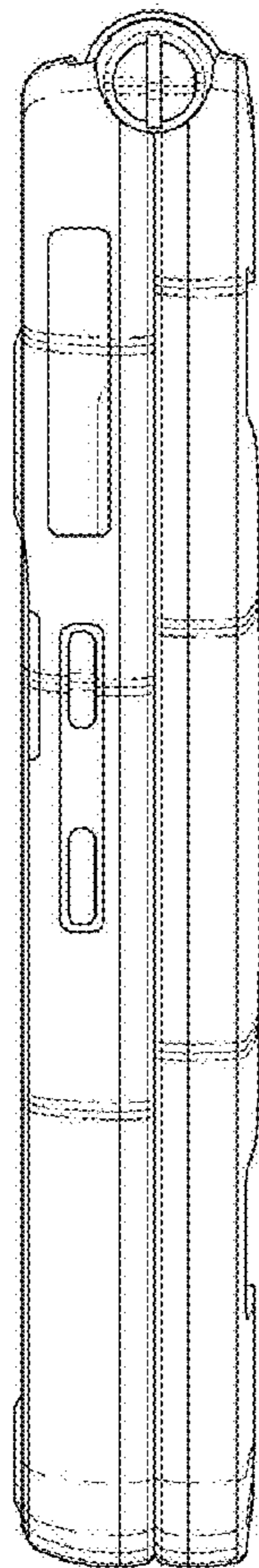

FIG. 5

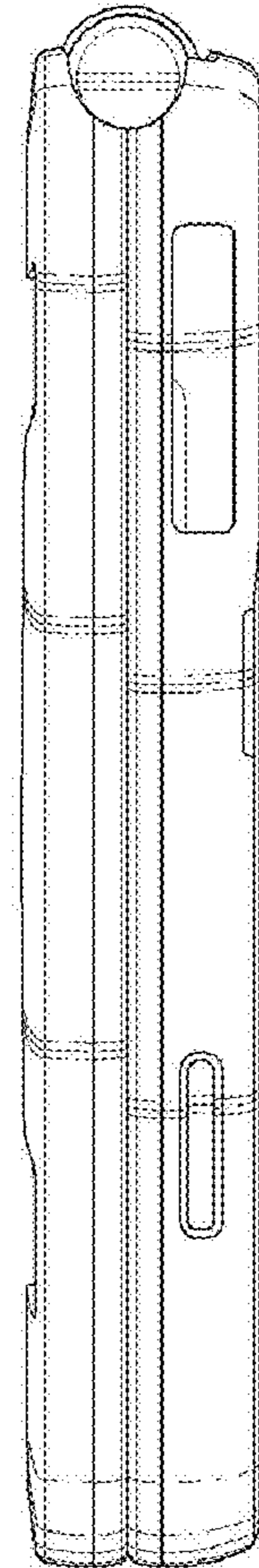

FIG. 6

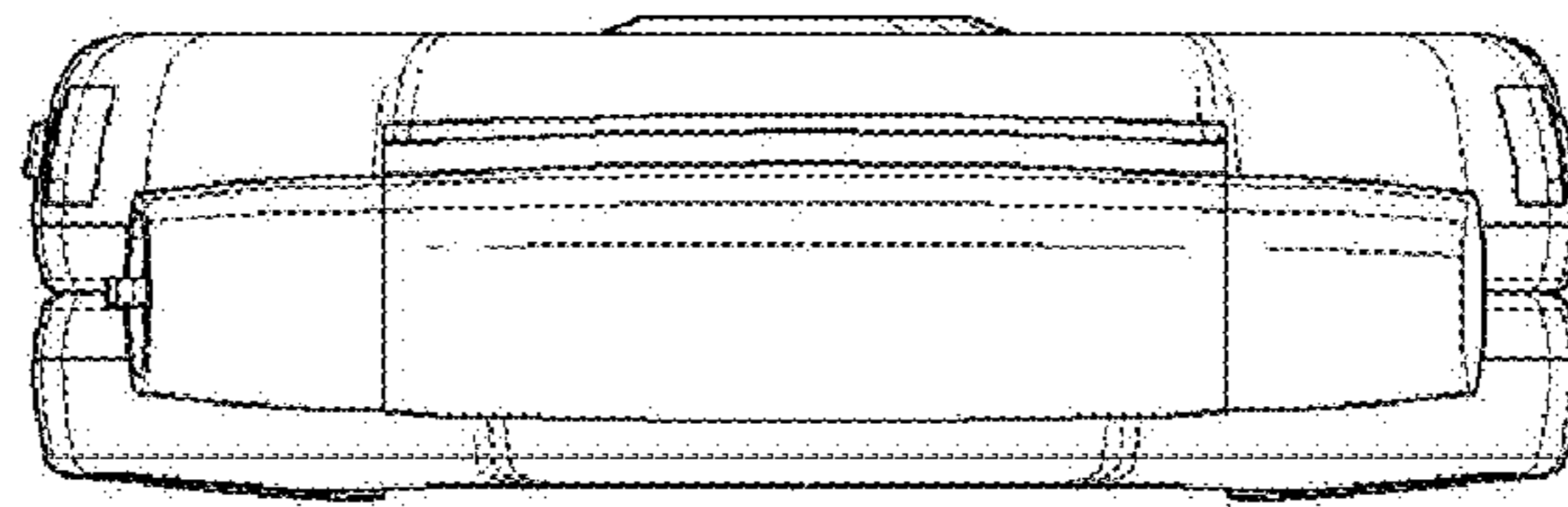

FIG. 7

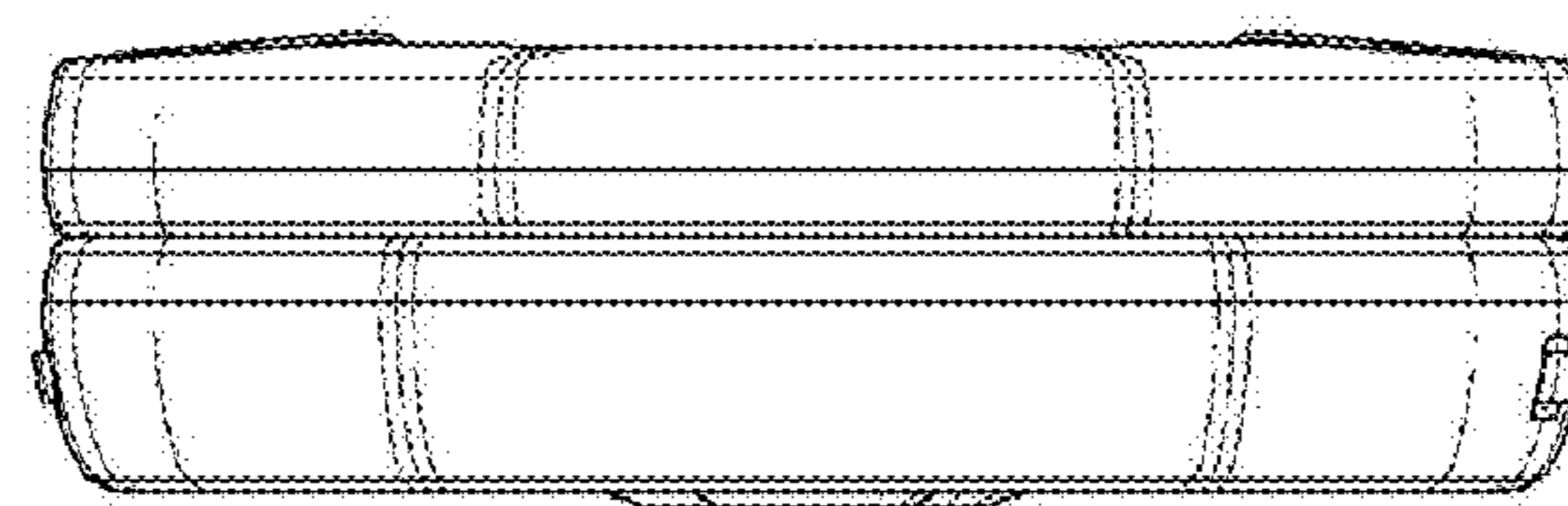

FIG. 8

