



US00D613705S

(12) **United States Design Patent**
Cha et al.

(10) **Patent No.:** **US D613,705 S**
(45) **Date of Patent:** **** Apr. 13, 2010**

(54) **MOBILE PHONE**

(75) Inventors: **Seong-Won Cha**, Seoul (KR);
Young-Keun Lee, Seoul (KR);
Chang-Hwan Hwang, Goyang-Si (KR)

(73) Assignee: **Samsung Electronics Co., Ltd**,
Suwon-Si (KR)

(**) Term: **14 Years**

(21) Appl. No.: **29/311,737**

(22) Filed: **Jun. 9, 2009**

(51) **LOC (9) Cl.** **14-03**

(52) **U.S. Cl.** **D14/138 AB**

(58) **Field of Classification Search** D14/138 AB,
D14/138 R, 138 AD, 345, 346, 147, 203.4,
D14/203.7, 203.2, 144; 455/575.3; 379/433.1,
379/433.11, 433.13; D21/517
See application file for complete search history.

(56) **References Cited**

U.S. PATENT DOCUMENTS

- D488,810 S * 4/2004 Lin et al. D14/341
- D509,816 S * 9/2005 Kim et al. D14/138 AB
- D510,733 S * 10/2005 Lee et al. D14/138 AB
- D512,038 S * 11/2005 Kim et al. D14/138 AB
- D545,798 S * 7/2007 Kimbre D14/138 AB
- D556,723 S * 12/2007 Lee D14/138 AB
- D562,295 S * 2/2008 Lindner et al. D14/138 AB
- D567,785 S * 4/2008 Lee et al. D14/138 AB
- D570,812 S * 6/2008 Bae D14/138 AB
- D571,338 S * 6/2008 Yoon D14/138 AB
- D572,691 S * 7/2008 Song et al. D14/138 AB
- D573,126 S * 7/2008 Lee et al. D14/138 AB
- D574,352 S * 8/2008 Cha et al. D14/138 AB
- D575,753 S * 8/2008 Lee et al. D14/138 AB
- D578,096 S * 10/2008 Park et al. D14/138 AB
- D582,881 S * 12/2008 Son et al. D14/138 AB
- D583,787 S * 12/2008 Kim et al. D14/138 AB
- D585,405 S * 1/2009 Lee et al. D14/138 AB
- D586,325 S * 2/2009 Park et al. D14/138 AB

- D587,673 S * 3/2009 Kim et al. D14/138 AB
- D593,050 S * 5/2009 Kim et al. D14/138 R
- D593,985 S * 6/2009 Park et al. D14/138 AB
- D598,410 S * 8/2009 Park D14/138 AB
- D598,881 S * 8/2009 Park et al. D14/138 AB
- D598,886 S * 8/2009 Chon et al. D14/138 AB
- D599,765 S * 9/2009 Park et al. D14/138 AB

OTHER PUBLICATIONS

Samsung X680 telephone, announced 2nd quarter 2006, [online], [site visited Nov. 16, 2009]. Available from Internet ,<URL: <http://www.gsmarena.com>>.*

(Continued)

Primary Examiner—Jeffrey D Asch

(57) **CLAIM**

The ornamental design for mobile phone, as shown and described.

DESCRIPTION

FIG. 1 is a front perspective view of a mobile phone;
FIG. 2 is a front view of the mobile phone of FIG. 1;
FIG. 3 is a rear view of the mobile phone of FIG. 1;
FIG. 4 is a left-side view of the mobile phone of FIG. 1;
FIG. 5 is a right-side view of the mobile phone of FIG. 1;
FIG. 6 is a top plan view of the mobile phone of FIG. 1;
FIG. 7 is a bottom plan view of the mobile phone of FIG. 1;
and,
FIG. 8 is a front open view of the mobile phone of FIG. 1.

1 Claim, 6 Drawing Sheets

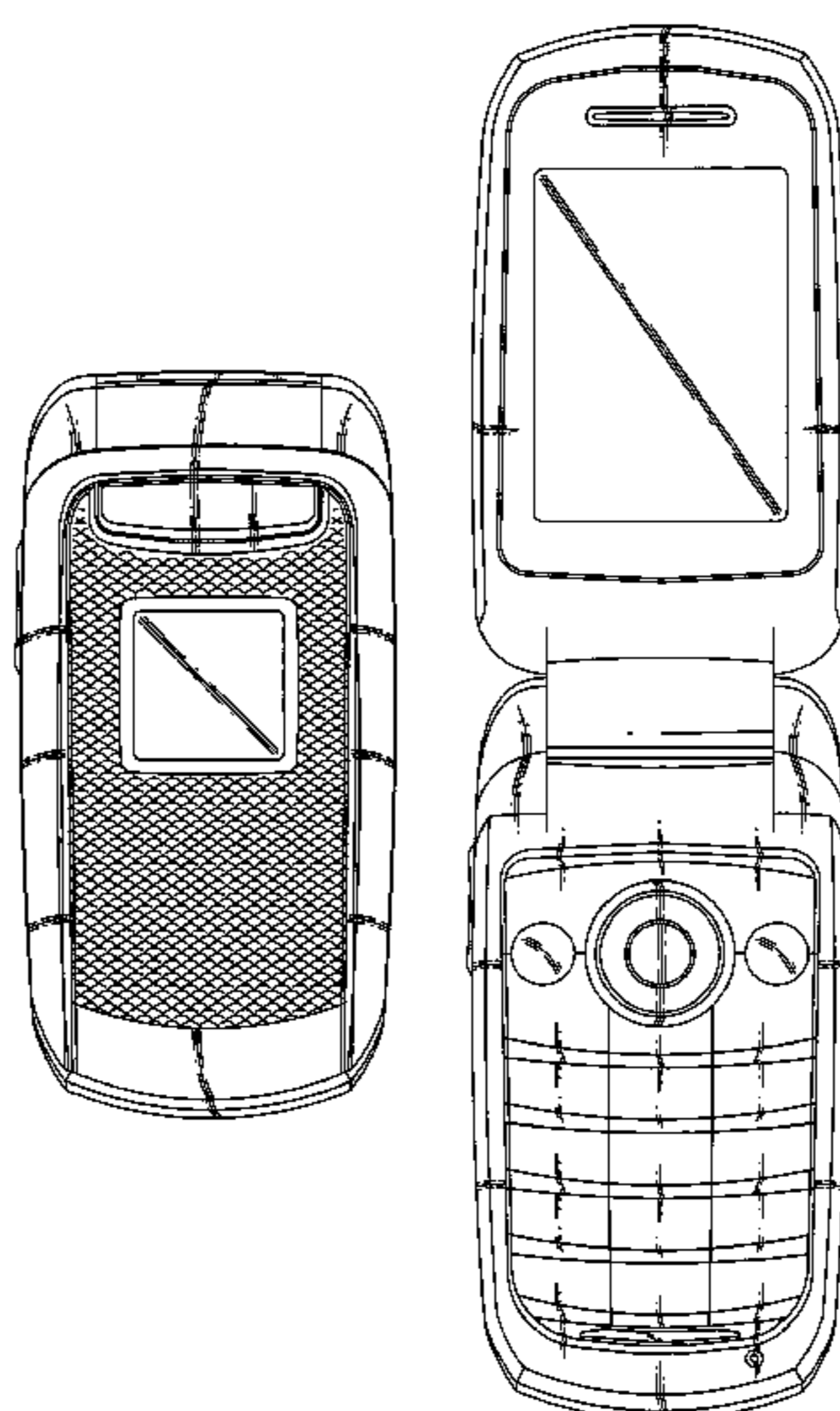

OTHER PUBLICATIONS

Samsung M310 telephone, announced May 2008, [online], [site visited Nov. 16, 2009]. Available from Internet ,<URL: <http://www.gsmarena.com>>.*

Motorola V560 telephone, announced 1st quarter 2005, [online], [site visited Nov. 16, 2009]. Available from Internet ,<URL: <http://www.gsmarena.com>>.*

Motorola MOTOACTV W450 telephone, announced 2008, [online], [site visited Nov. 16, 2009]. Available from Internet ,<URL: <http://www.gsmarena.com>>.*

Samsung CE110 telephone, announced Sep. 2007, [online], [site visited Nov. 16, 2009]. Available from Internet ,<URL: <http://www.gsmarena.com>>.*

* cited by examiner

FIG. 1

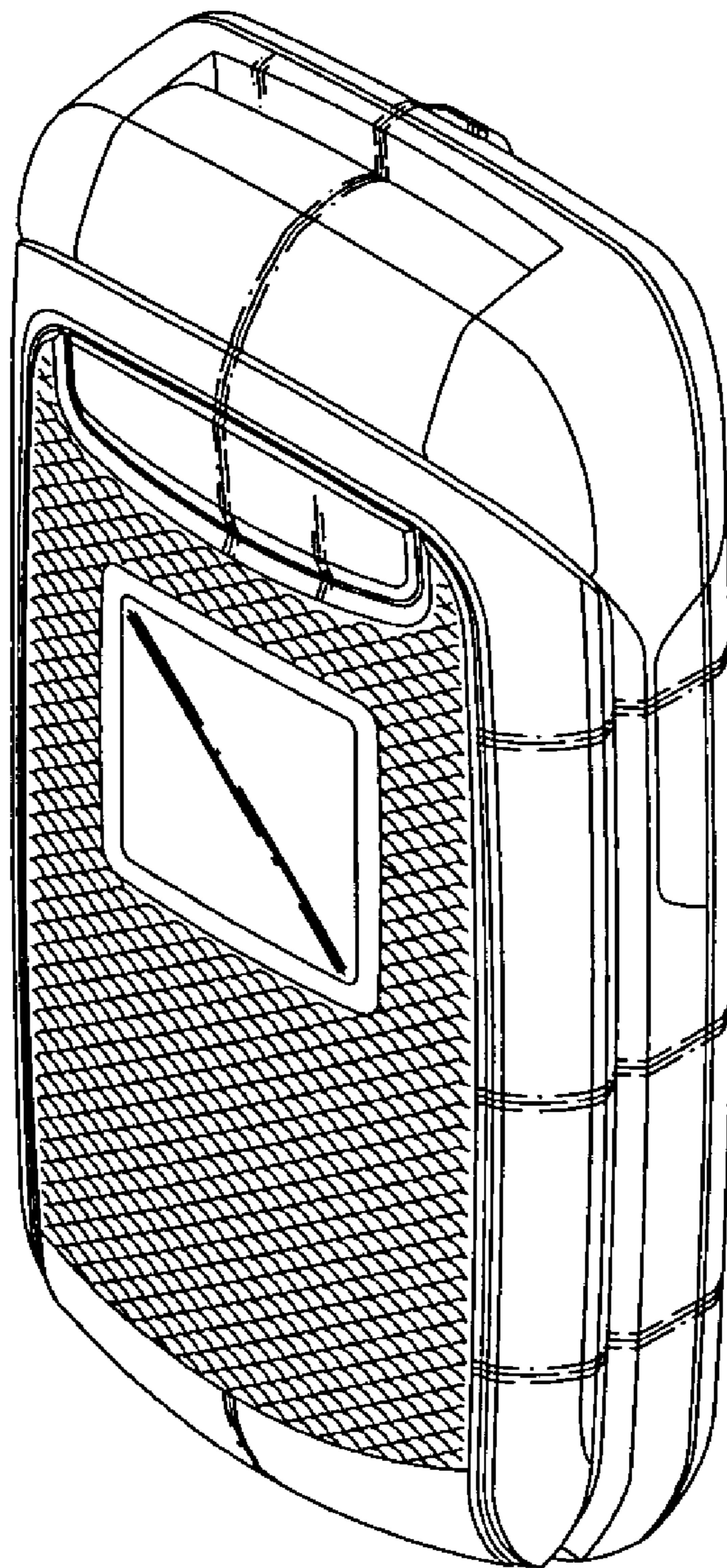

FIG. 2

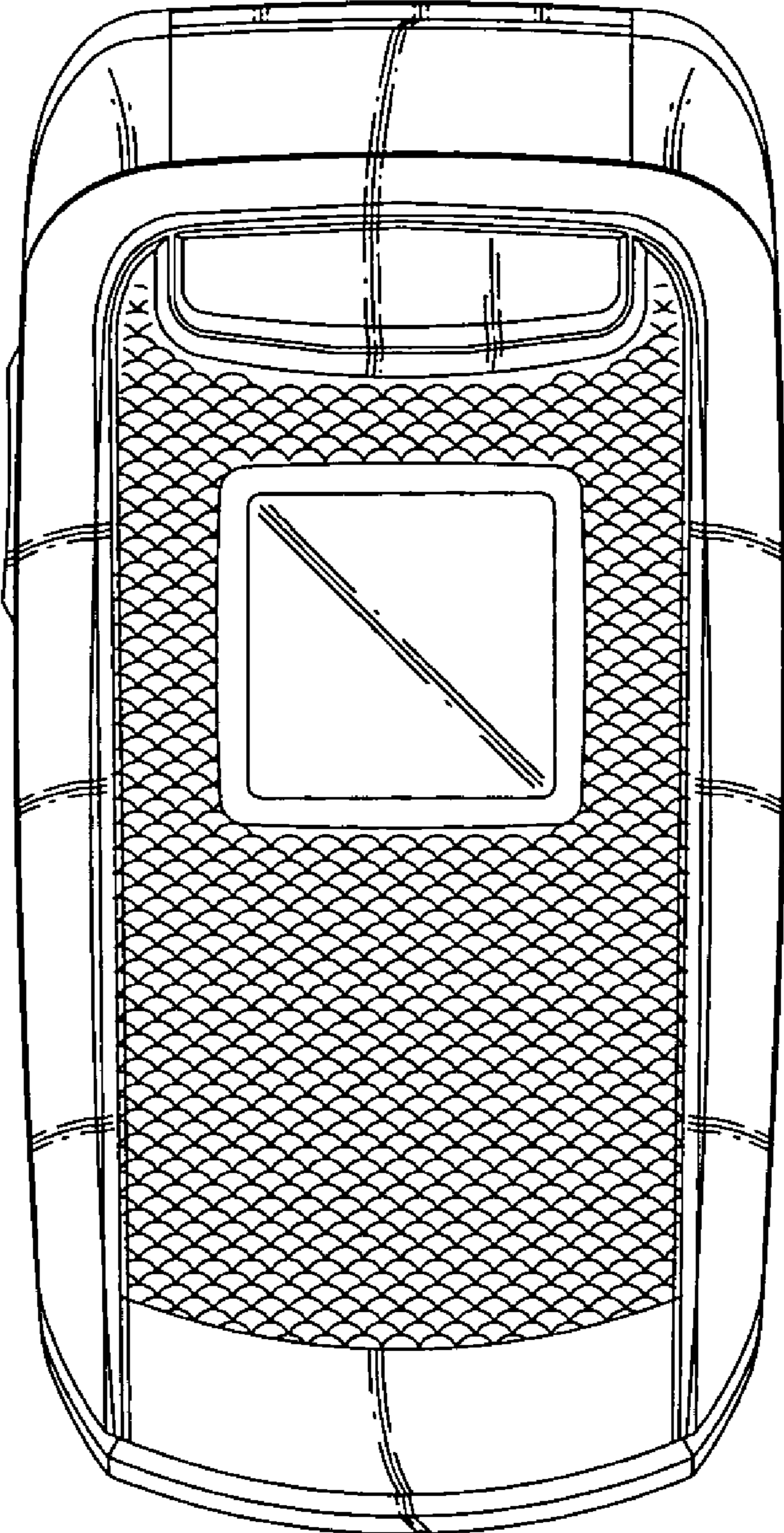

FIG. 3

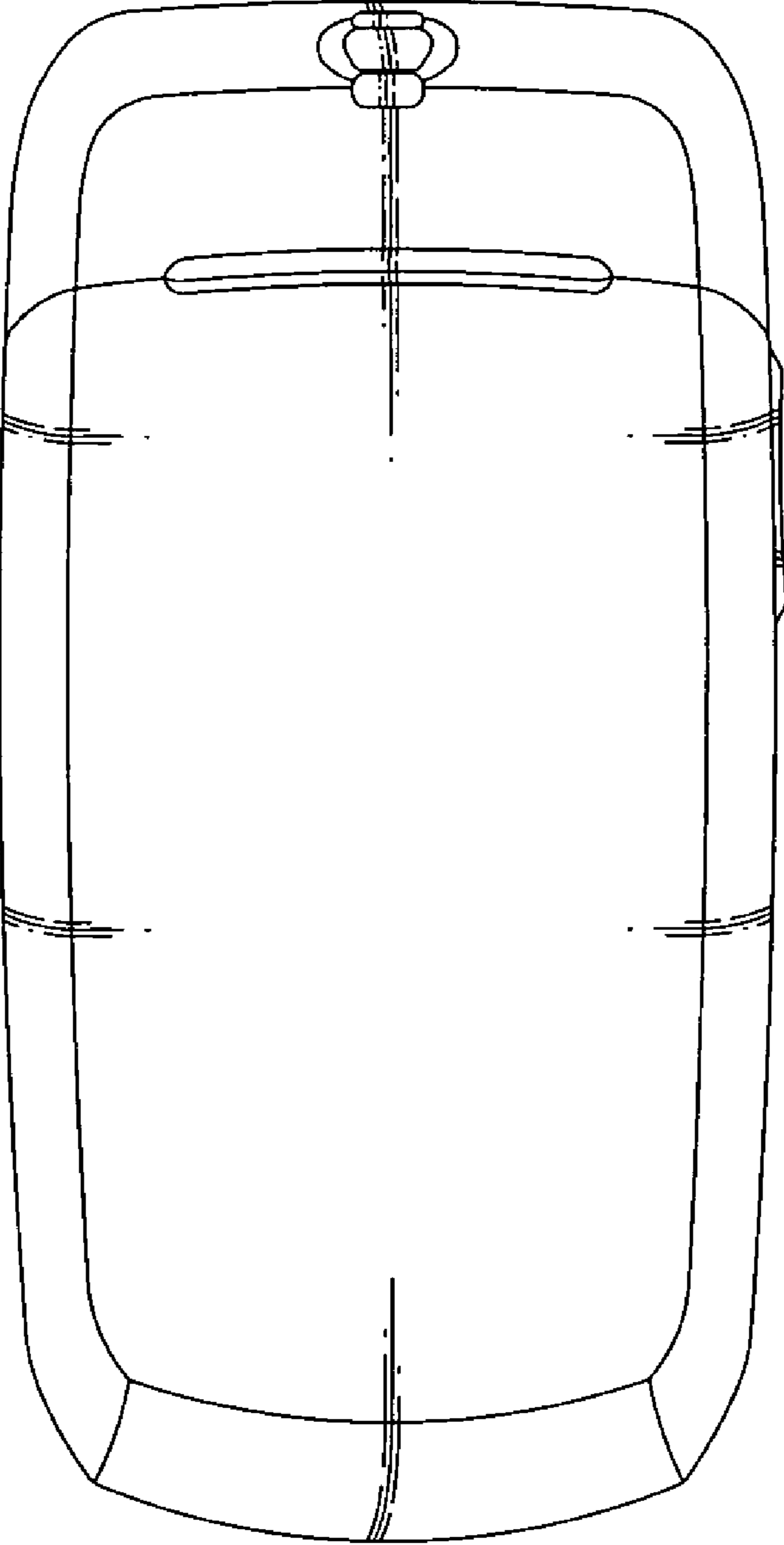

FIG. 4

FIG. 5

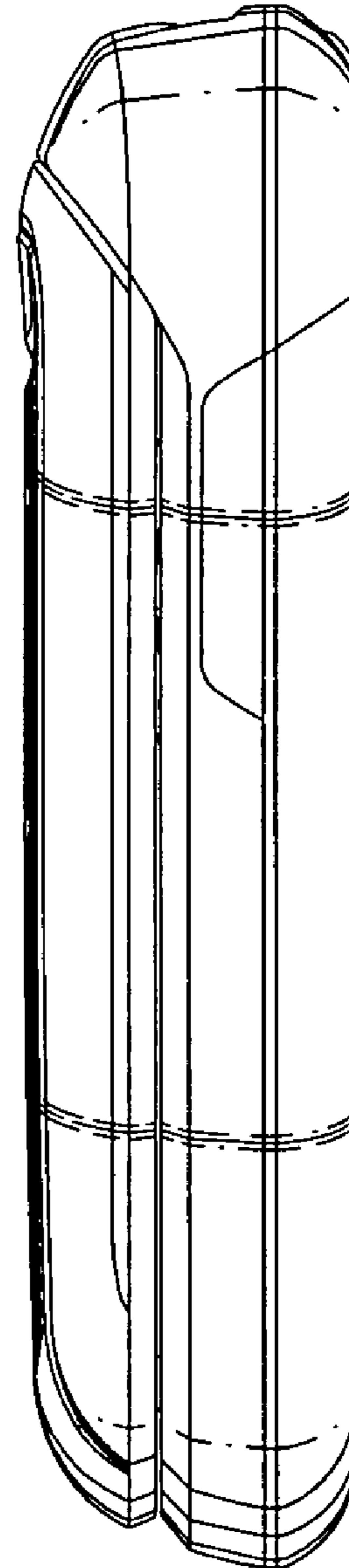
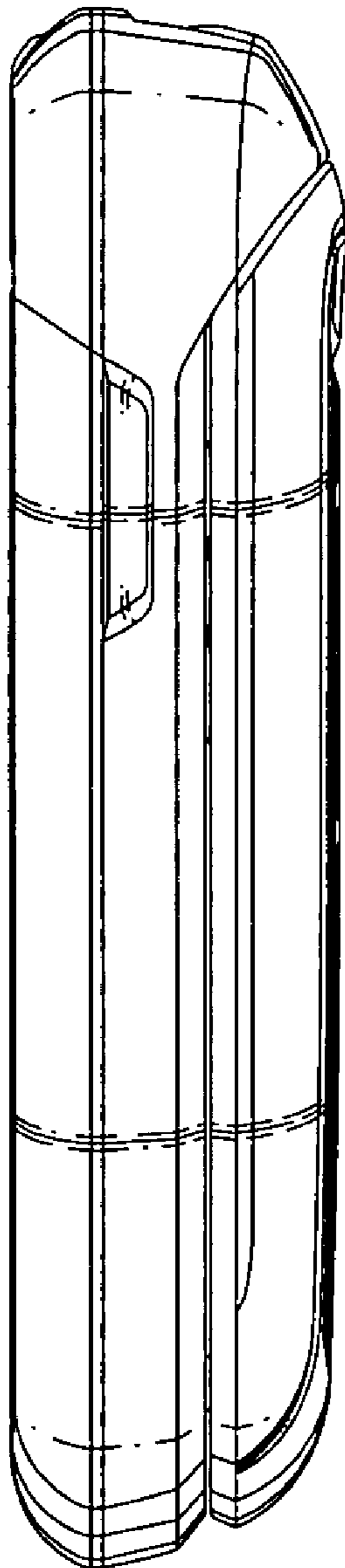

FIG. 6

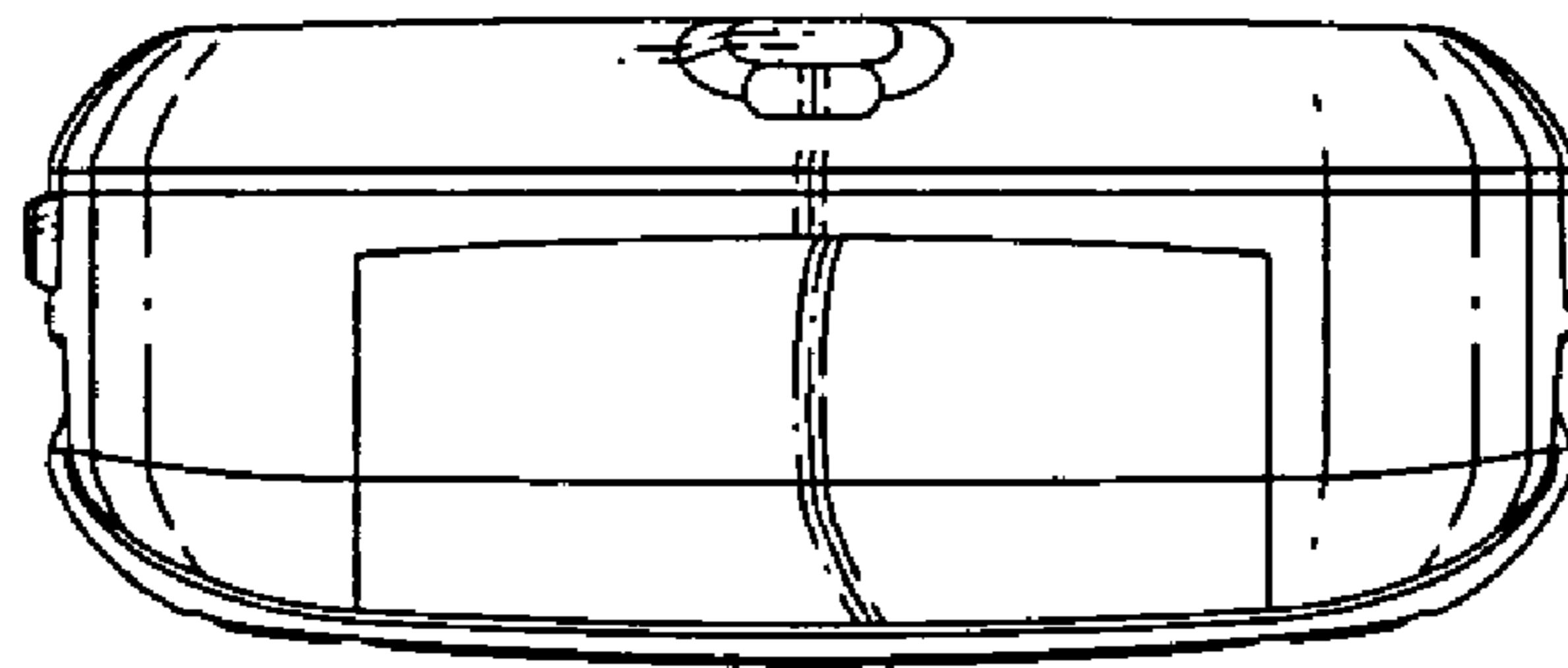

FIG. 7

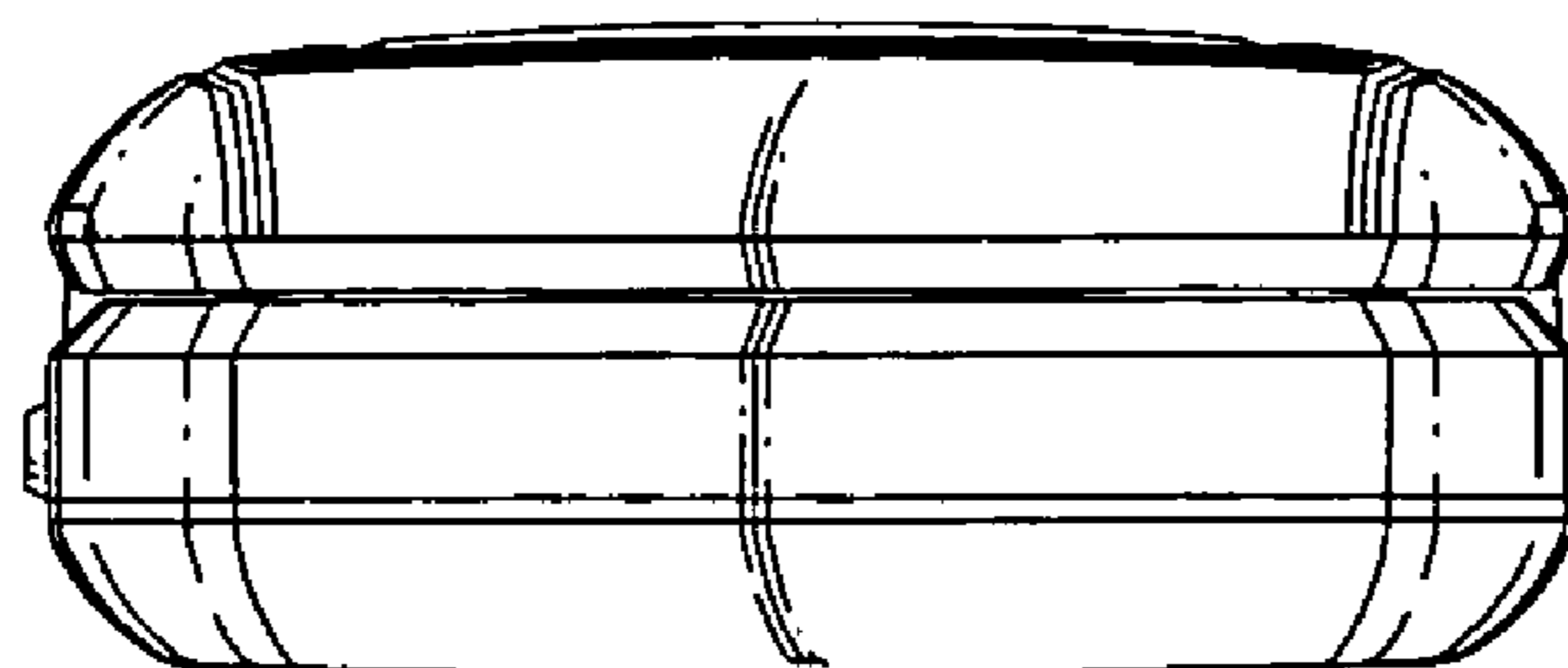

FIG. 8

