



US00D613498S

(12) **United States Design Patent**
Tsai

(10) **Patent No.:** **US D613,498 S**
(45) **Date of Patent:** **** Apr. 13, 2010**

(54) **CLIP FOR A MOBILE PHONE CASE**

(75) Inventor: **Chi Chin Tsai, Tai-Chung (TW)**

(73) Assignee: **Hsin Hong (Hong Kong) International Company Ltd, Kowloon, Hong Kong (CN)**

(**) Term: **14 Years**

(21) Appl. No.: **29/326,861**

(22) Filed: **Oct. 27, 2008**

(51) **LOC (9) Cl.** **03-01**

(52) **U.S. Cl.** **D3/218**

(58) **Field of Classification Search** D3/218,
D3/215; D14/253, 137, 138, 241, 251, 217;
379/455, 433-436; 24/3.1, 3.11, 3.12, 3.3,
24/3.4, 3.6, 3.7, 3.13; 224/240, 241, 236
See application file for complete search history.

(56) **References Cited**

U.S. PATENT DOCUMENTS

5,850,996 A * 12/1998 Liang 248/221.11
6,098,858 A * 8/2000 Laugesen 224/197

D448,924 S * 10/2001 Duh D3/218
D565,841 S * 4/2008 Kim D3/218
7,409,237 B2 * 8/2008 Tages 455/575.1
7,421,073 B2 * 9/2008 Tages et al. 379/446

* cited by examiner

Primary Examiner—T. Chase Nelson
Assistant Examiner—John Windmuller

(57) **CLAIM**

The ornamental design for a clip for a mobile phone case, as shown and described.

DESCRIPTION

FIG. 1 is a front elevational view of a clip for a mobile phone case showing my new design;

FIG. 2 is a rear elevational view thereof;

FIG. 3 is a left side elevational view thereof;

FIG. 4 is a right side elevational view thereof;

FIG. 5 is a top plan view thereof;

FIG. 6 is a bottom plan view thereof; and,

FIG. 7 is a perspective view thereof.

1 Claim, 6 Drawing Sheets

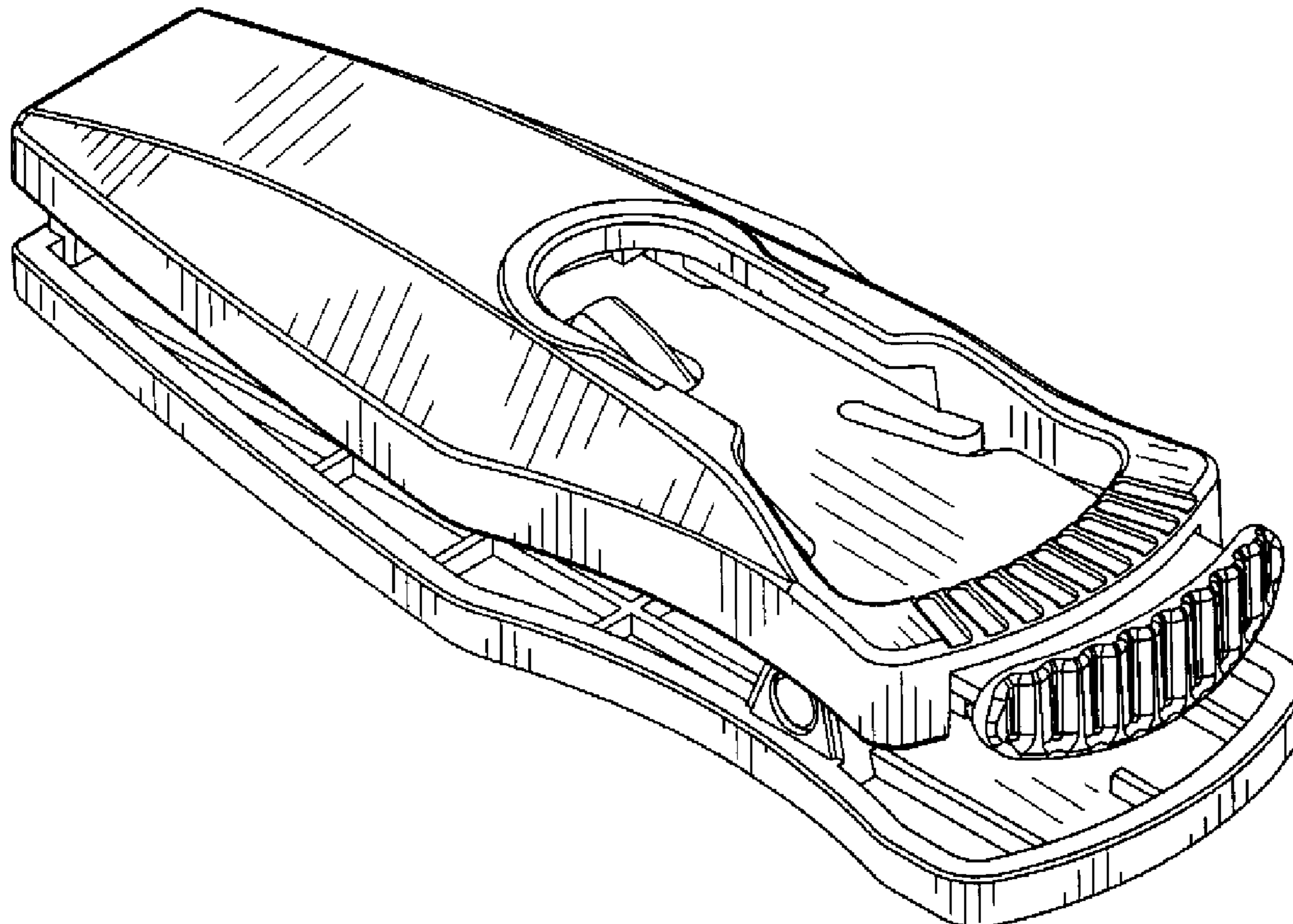

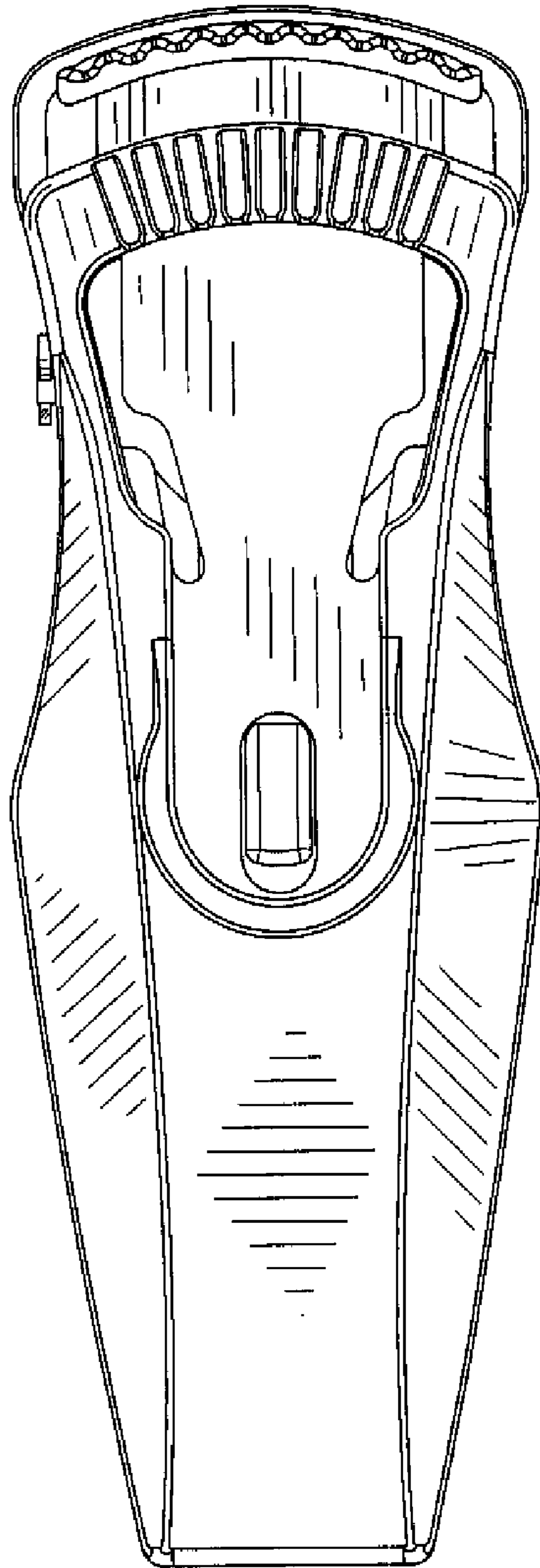

FIG. 1

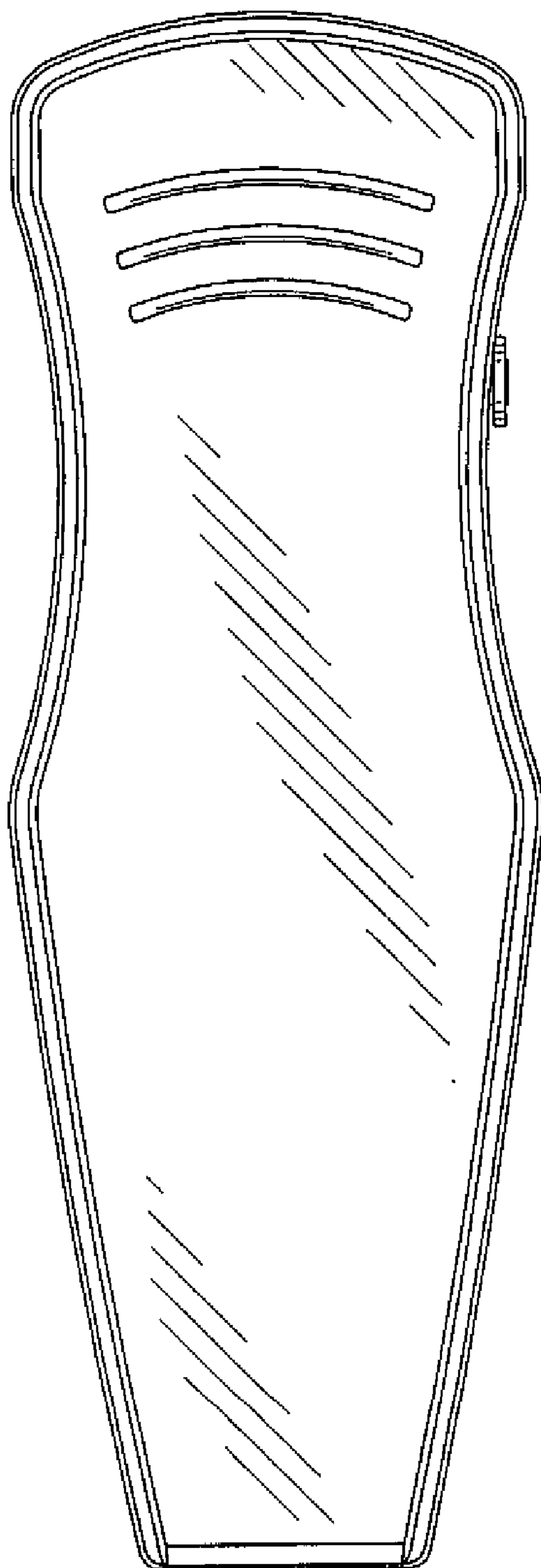

FIG. 2

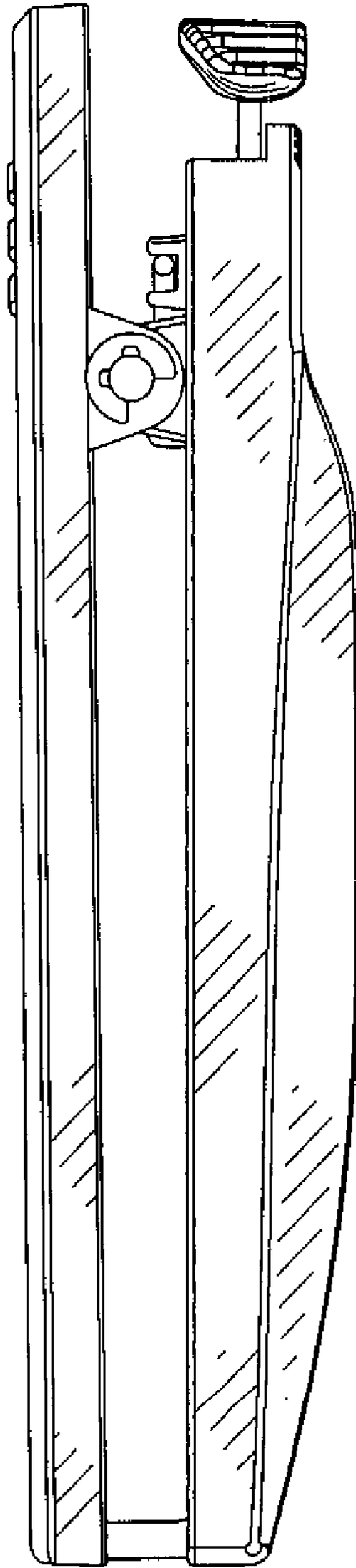

FIG. 3

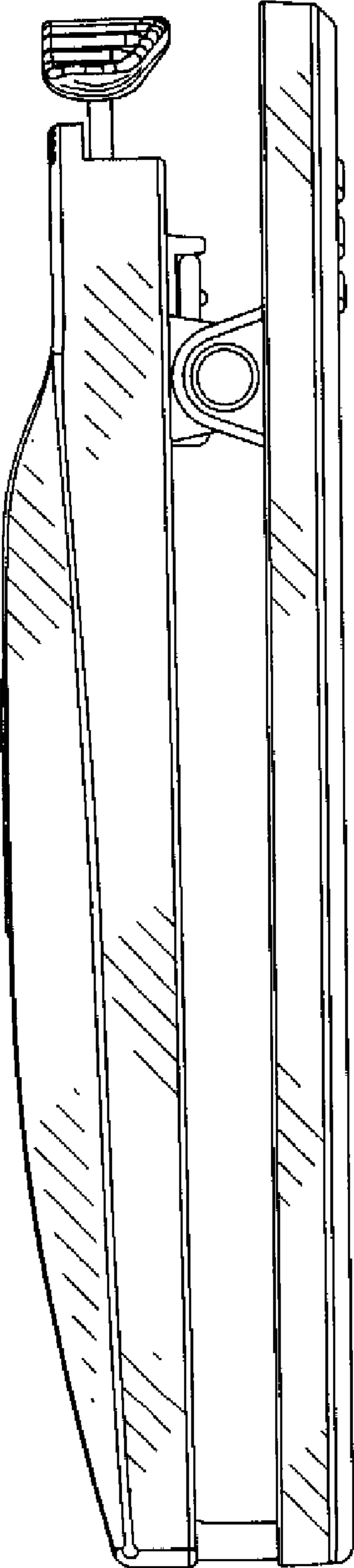

FIG. 4

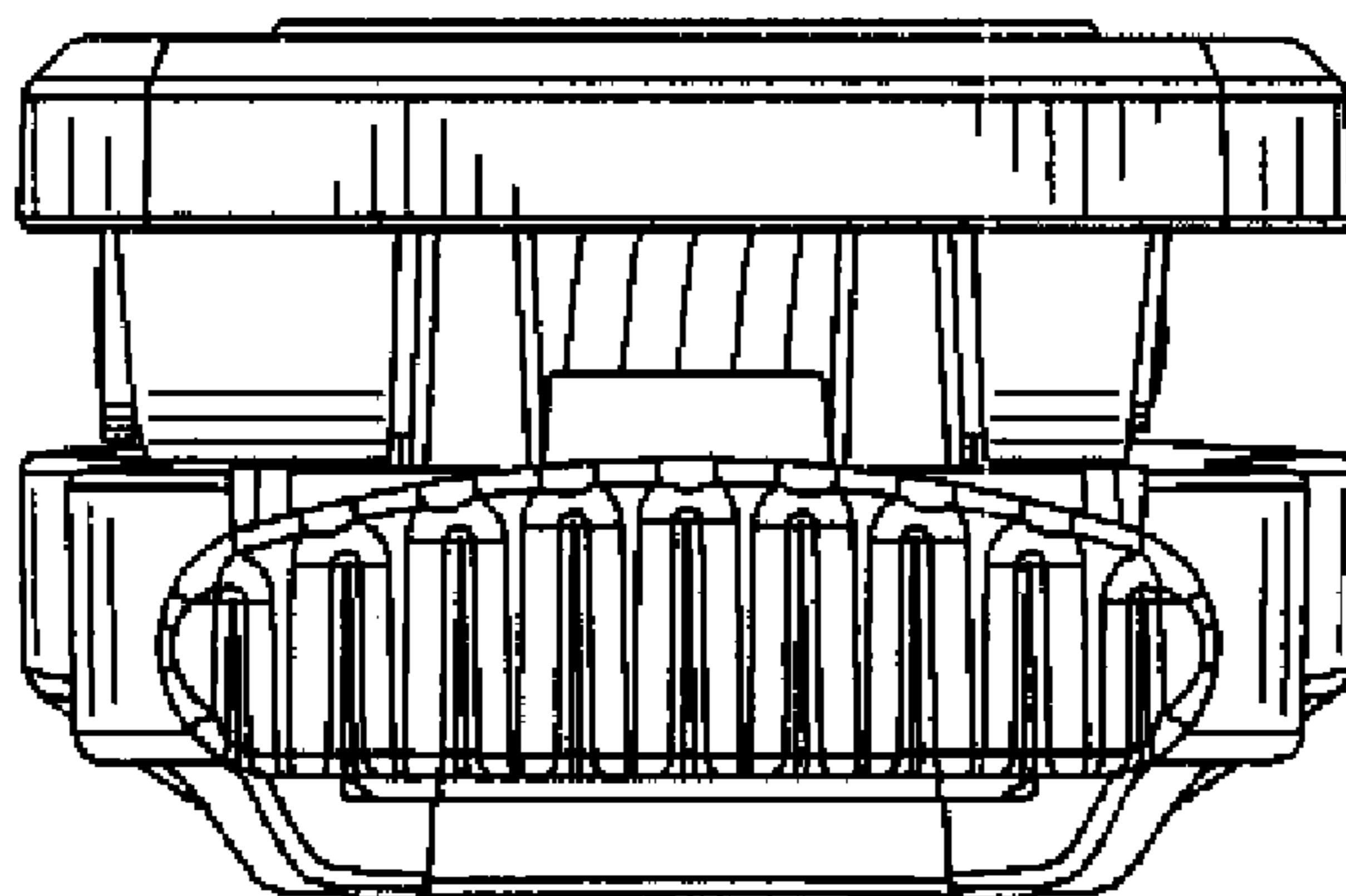

FIG. 5

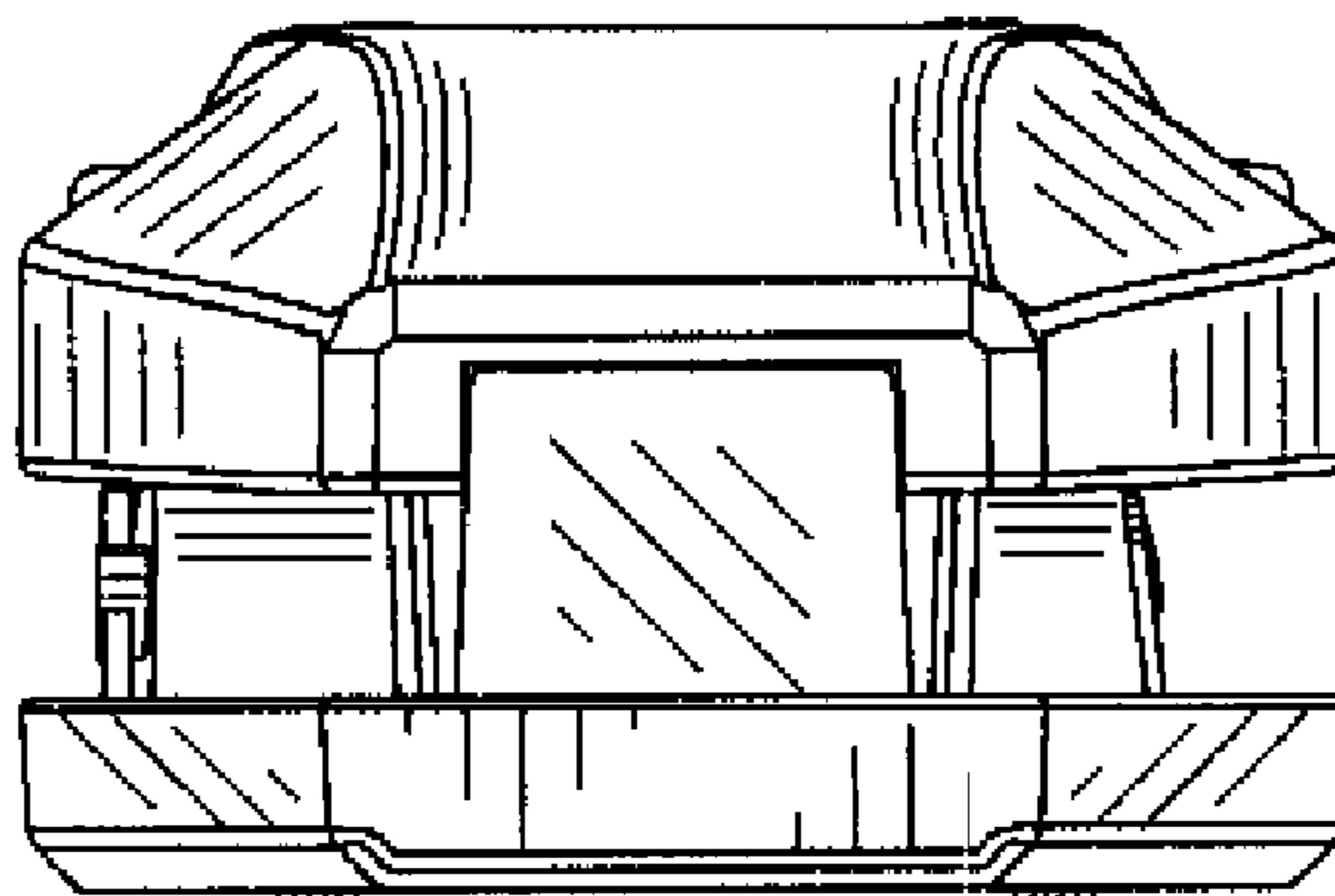

FIG. 6

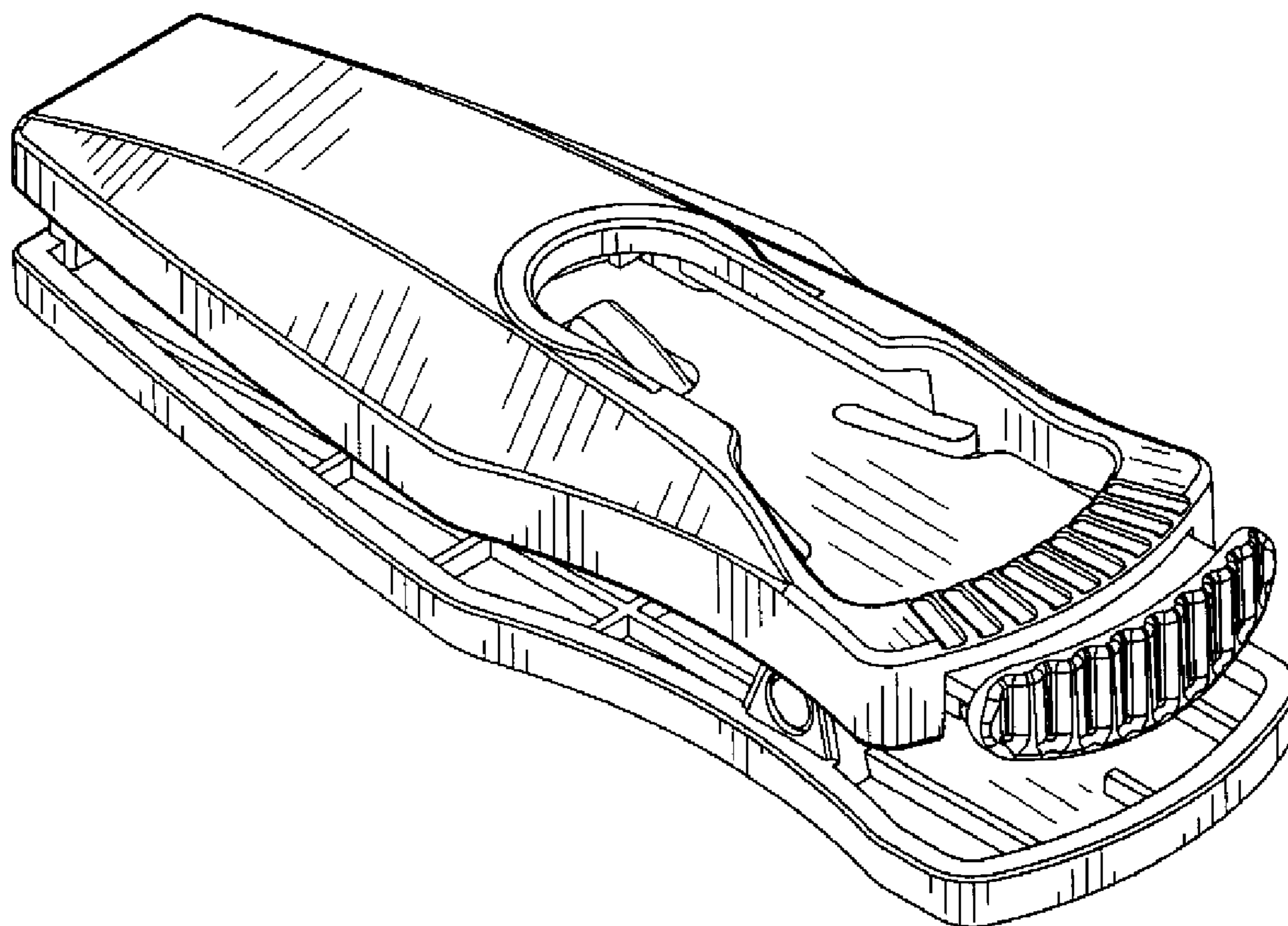

FIG. 7